

# Panasonic®

## Operating Instructions

---

4K Integrated Camera

Model No. **AW-UE150WP**

Model No. **AW-UE150KP**

Model No. **AW-UE150WE**

Model No. **AW-UE150KE**

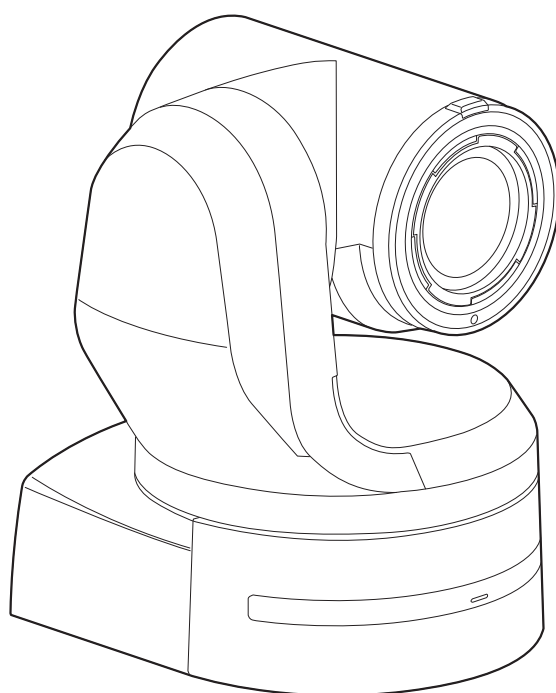

**HDMI**<sup>®</sup>  
HIGH-DEFINITION MULTIMEDIA INTERFACE

Before operating this product, please read the instructions carefully and save this manual for future use. Please carefully read the "Read this first!" (pages 2 to 6) of this Manual before use.

PJ EJ

W1118YM0-FJ

ENGLISH

DVQP1812ZA

# Read this first! (For AW-UE150WP, AW-UE150KP)



**CAUTION**  
**RISK OF ELECTRIC SHOCK**  
**DO NOT OPEN**



CAUTION: TO REDUCE THE RISK OF ELECTRIC SHOCK,  
DO NOT REMOVE COVER (OR BACK).  
NO USER SERVICEABLE PARTS INSIDE.  
REFER TO SERVICING TO QUALIFIED SERVICE PERSONNEL.



The lightning flash with arrowhead symbol, within an equilateral triangle, is intended to alert the user to the presence of uninsulated "dangerous voltage" within the product's enclosure that may be of sufficient magnitude to constitute a risk of electric shock to persons.



The exclamation point within an equilateral triangle is intended to alert the user to the presence of important operating and maintenance (servicing) instructions in the literature accompanying the appliance.

## WARNING:

- To reduce the risk of fire or electric shock, do not expose this equipment to rain or moisture.
- To reduce the risk of fire or electric shock, keep this equipment away from all liquids. Use and store only in locations which are not exposed to the risk of dripping or splashing liquids, and do not place any liquid containers on top of the equipment.

## WARNING:

Always keep the main unit mounting screw, bracket mounting screws and drop-prevention wire mounting screw out of the reach of infants and small children.

## CAUTION:

This apparatus can be operated at a voltage in the range of 100 – 240 V AC.  
Voltages other than 120 V are not intended for U.S.A. and Canada.  
Operation at a voltage other than 120 V AC may require the use of a different AC plug. Please contact either a local or foreign Panasonic authorized service center for assistance in selecting an alternate AC plug.

## CAUTION:

The mains plug of the power supply cord shall remain readily operable.  
The AC receptacle (mains socket outlet) shall be installed near the equipment and shall be easily accessible. To completely disconnect this equipment from the AC mains, disconnect the power cord plug from the AC receptacle.

## CAUTION:

In order to maintain adequate ventilation, do not install or place this unit in a bookcase, built-in cabinet or any other confined space. To prevent risk of electric shock or fire hazard due to overheating, ensure that curtains and any other materials do not obstruct the ventilation.

## CAUTION:

To reduce the risk of fire or electric shock and annoying interference, use the recommended accessories only.

## CAUTION:

Check the installation at least once a year.  
An improper installation could cause the unit to fall off resulting in personal injury.

## CAUTION:

Do not pick up and move the unit while the tripod is attached. The fitting may break under the weight of the tripod, which may result in injury.

## CAUTION:

Naked flame sources, such as lighted candles, should not be placed on the apparatus.

 indicates safety information.

## FCC NOTICE (USA)

This device complies with part 15 of the FCC Rules.

Operation is subject to the following two conditions:

(1) This device may not cause harmful interference, and (2) this device must accept any interference received, including interference that may cause undesired operation.

### CAUTION:

This equipment has been tested and found to comply with the limits for a class A digital device, pursuant to Part 15 of the FCC Rules.

These limits are designed to provide reasonable protection against harmful interference when the equipment is operated in a commercial environment. This equipment generates, uses, and can radiate radio frequency energy and, if not installed and used in accordance with the instruction manual, may cause harmful interference to radio communications.

Operation of this equipment in a residential area is likely to cause harmful interference in which case the user will be required to correct the interference at his own expense.

### FCC Warning:

To assure continued FCC emission limit compliance, follow the attached installation instructions and the user must use only shielded interface cables when connecting to host computer or peripheral devices. Also, any unauthorized changes or modifications to this equipment could void the user's authority to operate this device.

## NOTIFICATION (Canada)

CAN ICES-3 (A)/NMB-3(A)

 indicates safety information.

# IMPORTANT SAFETY INSTRUCTIONS

- 1) Read these instructions.
- 2) Keep these instructions.
- 3) Heed all warnings.
- 4) Follow all instructions.
- 5) Do not use this apparatus near water.
- 6) Clean only with dry cloth.
- 7) Do not block any ventilation openings. Install in accordance with the manufacturer's instructions.
- 8) Do not install near any heat sources such as radiators, heat registers, stoves, or other apparatus (including amplifiers) that produce heat.
- 9) Do not defeat the safety purpose of the polarized or grounding-type plug. A polarized plug has two blades with one wider than the other. A grounding-type plug has two blades and a third grounding prong. The wide blade or the third prong are provided for your safety. If the provided plug does not fit into your outlet, consult an electrician for replacement of the obsolete outlet.
- 10) Protect the power cord from being walked on or pinched particularly at plugs, convenience receptacles, and the point where they exit from the apparatus.
- 11) Only use attachments/accessories specified by the manufacturer.
- 12) Use only with the cart, stand, tripod, bracket, or table specified by the manufacturer, or sold with the apparatus. When a cart is used, use caution when moving the cart/apparatus combination to avoid injury from tip-over.
- 13) Unplug this apparatus during lightning storms or when unused for long periods of time.
- 14) Refer all servicing to qualified service personnel. Servicing is required when the apparatus has been damaged in any way, such as power-supply cord or plug is damaged, liquid has been spilled or objects have fallen into the apparatus, the apparatus has been exposed to rain or moisture, does not operate normally, or has been dropped.



## Read this first! (For AW-UE150WE, AW-UE150KE)

### WARNING:

- To reduce the risk of fire or electric shock, do not expose this equipment to rain or moisture.
- To reduce the risk of fire or electric shock, keep this equipment away from all liquids. Use and store only in locations which are not exposed to the risk of dripping or splashing liquids, and do not place any liquid containers on top of the equipment.

### WARNING:

Always keep the main unit mounting screw, bracket mounting screws and drop-prevention wire mounting screw out of the reach of infants and small children.

### CAUTION:

Do not remove panel covers by unscrewing.  
To reduce the risk of electric shock, do not remove the covers.  
No user serviceable parts inside.  
Refer servicing to qualified service personnel.

### CAUTION:

The mains plug of the power supply cord shall remain readily operable.  
The AC receptacle (mains socket outlet) shall be installed near the equipment and shall be easily accessible. To completely disconnect this equipment from the AC mains, disconnect the power cord plug from the AC receptacle.

### CAUTION:

In order to maintain adequate ventilation, do not install or place this unit in a bookcase, built-in cabinet or any other confined space. To prevent risk of electric shock or fire hazard due to overheating, ensure that curtains and any other materials do not obstruct the ventilation.

### CAUTION:

To reduce the risk of fire or electric shock and annoying interference, use the recommended accessories only.

### CAUTION:

Check the installation at least once a year.  
An improper installation could cause the unit to fall off resulting in personal injury.

### CAUTION:

Do not pick up and move the unit while the tripod is attached.  
The fitting may break under the weight of the tripod, which may result in injury.

### CAUTION:

Naked flame sources, such as lighted candles, should not be placed on the apparatus.

 indicates safety information.

### Turkey Only

AEEE Yönetmeliğine Uygundur.

AEEE Complies with Directive of Turkey.

## EMC NOTICE FOR THE PURCHASER/USER OF THE APPARATUS

### 1. Pre-requisite conditions to achieving compliance with the above standards

#### <1> Peripheral equipment to be connected to the apparatus and special connecting cables

- The purchaser/user is urged to use only equipment which has been recommended by us as peripheral equipment to be connected to the apparatus.
- The purchaser/user is urged to use only the connecting cables described below.

#### <2> For the connecting cables, use shielded cables which suit the intended purpose of the apparatus.

- Video signal connecting cables  
Use double shielded coaxial cables, which are designed for 75-ohm type high-frequency applications, for SDI (Serial Digital Interface).  
Coaxial cables, which are designed for 75-ohm type high-frequency applications, are recommended for analog video signals.
- Audio signal connecting cables  
If your apparatus supports AES/EBU serial digital audio signals, use cables designed for AES/EBU.  
Use shielded cables, which provide quality performance for high-frequency transmission applications, for analog audio signals.
- Other connecting cables (IEEE1394, USB)  
Use double shielded cables, which provide quality performance for high-frequency applications, as connecting cables.
- When connecting to the DVI signal terminal, use a cable with a ferrite core.
- If your apparatus is supplied with ferrite core(s), they must be attached on cable(s) following instructions in this manual.

### 2. Performance level

The performance level of the apparatus is equivalent to or better than the performance level required by these standards.

However, the apparatus may be adversely affected by interference if it is being used in an EMC environment, such as an area where strong electromagnetic fields are generated (by the presence of signal transmission towers, cellular phones, etc.). In order to minimize the adverse effects of the interference on the apparatus in cases like this, it is recommended that the following steps be taken with the apparatus being affected and with its operating environment:

1. Place the apparatus at a distance from the source of the interference.
2. Change the direction of the apparatus.
3. Change the connection method used for the apparatus.
4. Connect the apparatus to another power outlet where the power is not shared by any other appliances.



### Disposal of Old Equipment

#### Only for European Union and countries with recycling systems

This symbol on the products, packaging, and/or accompanying documents means that used electrical and electronic products must not be mixed with general household waste.

For proper treatment, recovery and recycling of old products, please take them to applicable collection points in accordance with your national legislation.

By disposing of them correctly, you will help to save valuable resources and prevent any potential negative effects on human health and the environment. For more information about collection and recycling, please contact your local municipality, dealer or supplier. Penalties may be applicable for incorrect disposal of this waste, in accordance with national legislation.

### Інформація для покупця

Виробник:	Panasonic Corporation	Панасонік Корпорейшн
Адреса виробника:	Kadoma, Osaka, Japan	Кадома, Осака, Японія
Країна походження:	Japan	Японія

Імпортер:	ТОВ "ПАНАСОНІК УКРАЇНА ЛТД"
Адреса імпортера:	провулок Охтирський, будинок 7, місто Київ, 03022, Україна

#### Примітки:

Термін служби виробу	7 років
----------------------	---------

Дата виготовлення може бути визначена за допомогою комбінації літер та цифр серійного номера, розташованого на продукті.

Приклад: X X XXXXXXX

Рік: остання цифра року (7 – 2017, 8 – 2018,...0 – 2020)
Місяць: А – Січень, В – Лютий... L – Грудень

Manufactured by: Panasonic Corporation, Osaka, Japan  
Importer's name and address of pursuant to EU rules:  
Panasonic Marketing Europe GmbH  
Panasonic Testing Centre  
Winsbergring 15, 22525 Hamburg, Germany

# Read this first!

## Note on grounding

- Ground the unit via the <SIGNAL GND> ground connector.

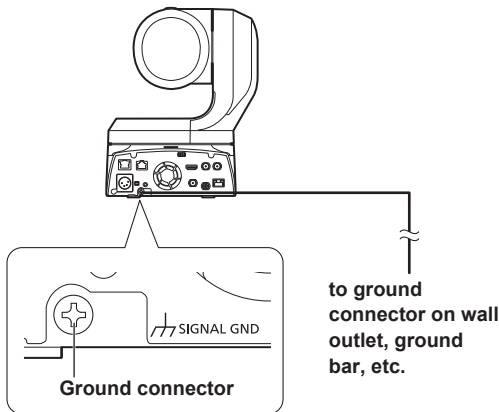

## ■ Trademarks and registered trademarks

- Microsoft®, Windows®, Windows® 7, Windows® 10, Microsoft Edge, Internet Explorer®, ActiveX® and DirectX® are either registered trademarks or trademarks of Microsoft Corporation in the United States and other countries.
- Apple, Mac, OS X, iPhone, iPod Touch, iPad, and Safari are registered trademarks of Apple Inc., in the United States and other countries.
- Android™ is a trademark of Google LLC.
- Intel® and Intel® Core™ are trademarks or registered trademarks of Intel Corporation in the United States and other countries.
- Adobe® and Reader® are either registered trademarks or trademarks of Adobe Systems Incorporated in the United States and/or other countries.
- The terms HDMI and HDMI High-Definition Multimedia Interface, and the HDMI Logo are trademarks or registered trademarks of HDMI Licensing Administrator, Inc. in the United States and other countries.
- Other names of companies and products contained in these Operating Instructions may be trademarks or registered trademarks of their respective owners.

## ■ About copyright and licence

Distributing, copying, disassembling, reverse compiling, reverse engineering, and also exporting in violation of export laws of the software provided with this unit are expressly prohibited.

## ■ Abbreviations

The following abbreviations are used in this manual.

- Microsoft® Windows® 7 Professional SP1 32/64-bit is abbreviated to “Windows 7”.
- Windows® Internet Explorer® 11.0 32/64-bit is abbreviated to “Internet Explorer”.

For the purposes of this manual, the model numbers of the units are given as listed in the table below.

Model number of unit	Model number given in manual
AW-UE150WP	<b>AW-UE150</b>
AW-UE150KP	
AW-UE150WE	
AW-UE150KE	
AW-HE130W	<b>AW-HE130</b>
AW-HE130K	
AW-HS50N	<b>AW-HS50</b>
AW-HS50E	
AW-RP50N	<b>AW-RP50</b>
AW-RP50E	
AW-RP120G	<b>AW-RP120</b>
AW-RP150G	<b>AW-RP150</b>
AK-HRP200G	<b>AK-HRP200</b>

## ■ Illustrations and screen displays featured in the manual

- What is shown in the manual's illustrations and screen displays may differ from how it is actually appears.
- Functions which can be used by Windows Internet Explorer 11 only are indicated using the [Windows I.E.11](#) mark.
- The screenshots are used in accordance with the guidelines of Microsoft Corporation.

# Contents

<b>Read this first! (For AW-UE150WP, AW-UE150KP)</b> .....	2
<b>Read this first! (For AW-UE150WE, AW-UE150KE)</b> .....	4
<b>Read this first!</b> .....	7
Note on grounding .....	7
<b>Before use</b> .....	9
Overview .....	9
Computer requirements .....	9
Disclaimer of warranty .....	10
Network security .....	10
<b>Features</b> .....	11
<b>Controller supported</b> .....	12
<b>Accessories</b> .....	13
<b>Optional accessories</b> .....	13
<b>Operating precautions</b> .....	14
<b>Wireless remote control (optional accessory)</b> .....	16
<b>Parts and their functions</b> .....	17
Camera unit .....	17
Wireless remote control (not supplied) .....	24
<b>Setting the remote control IDs</b> .....	26
<b>Network settings</b> .....	27
Use the Easy IP Setup Software to establish the unit's settings .....	27
Installing the plug-in viewer software .....	28
User authentication .....	28
<b>Basic shooting operations</b> .....	29
<b>How to turn the power on and off</b> .....	29
Turning the power on .....	29
Turning the power off .....	29
<b>Selecting the units</b> .....	30
<b>Selecting the shooting modes (scene files)</b> .....	31
Types of shooting modes .....	31
How to select the shooting mode .....	31
<b>Shooting</b> .....	32
<b>What to do when encountering problems in the basic shooting operations</b> .....	33
<b>More advanced operations</b> .....	33
<b>Manual shooting</b> .....	34
Manually adjusting the focus .....	34
Manually adjusting the iris .....	34
Manually adjusting the shutter speed .....	34
Manually adjusting the gain .....	34
<b>Preset memories</b> .....	35
<b>White balance adjustment</b> .....	36
Automatic adjustment (AWB: AWB A or AWB B) .....	36
Auto tracking white adjustment (ATW) .....	37
3200K and 5600K presets .....	37
VAR .....	37
<b>Black balance adjustment</b> .....	38
Automatic adjustment .....	38
<b>Black level (master pedestal) adjustment</b> .....	39
<b>Genlock adjustment</b> .....	40
Horizontal phase adjustment .....	40
<b>Basic setup operations</b> .....	41
When performing the operations using the wireless remote control .....	41
<b>Camera menu items</b> .....	42
Setting the camera menu items .....	42
Top Menu screen .....	42
Camera screen .....	43
Brightness 1/2 screen .....	43
Brightness 2/2 screen .....	44
Picture 1/8 screen .....	45
Picture 2/8 screen .....	46
Picture 3/8 screen .....	47
Picture 4/8 screen .....	47
Picture 5/8 screen .....	48
Picture 6/8 screen .....	49
Picture 7/8 screen .....	50
Picture 8/8 screen .....	50
Matrix 1/5 screen .....	51
Matrix 2/5 screen .....	51
Matrix 3/5 screen .....	52
Matrix 4/5 screen .....	52
Matrix 5/5 screen .....	53
Lens screen .....	53
System screen .....	54
Output 1/6 screen .....	56
Output 2/6 screen .....	57
Output 3/6 screen .....	58
Output 4/6 screen .....	58
Output 5/6 screen .....	59
Output 6/6 screen .....	59
Pan/Tilt screen .....	60
Preset 1/2 screen .....	61
Preset 2/2 screen .....	62
Maintenance screen .....	62
Firmware Version 1/2 screen .....	63
Firmware Version 2/2 screen .....	63
IP Network screen .....	64
Hour Meter screen .....	65
Error Status screen .....	65
<b>Camera menu item table</b> .....	66
<b>Displaying the web screen</b> .....	72
Displaying the web screen using a personal computer .....	72
Switching between the Live screen [Live] and Web setup screen [Setup] .....	74
<b>Web screen operations</b> .....	75
Live screen [Live] .....	75
<b>Web screen configurations</b> .....	80
Logging into the Web screen .....	80
Web setup screen [SetUp] .....	81
Setting status screen [Setting Status] .....	83
Basic screen [Basic] .....	84
Image/audio screen [Image/Audio] .....	90
User management screen [User mng.] .....	107
Network setup screen [Network] .....	110
Maintenance screen [Maintenance] .....	122
<b>Displaying the web screen using a mobile terminal</b> .....	125
<b>System log displays</b> .....	129
<b>Limiters</b> .....	131
<b>Setting/releasing the limiters</b> .....	132
Basic limiter operations .....	132
Setting the limiters .....	132
Releasing the limiters .....	132
Resetting the limiters .....	132
<b>Safe mode</b> .....	133
Concerning the safe mode .....	133
Detection of equipment trouble .....	133
<b>Troubleshooting</b> .....	134
<b>Specifications</b> .....	143
<b>Index</b> .....	145



## Before use

### Overview

- This product is an all-in-one pan-tilt head remote camera, compatible with 4K/60p format, and the first in its field to support 4K/12G-SDI.
- Equipped with an optical 20x zoom lens and 4K-compatible MOS sensor, it is possible to record high-quality images with a high degree of realism with the horizontal resolution of 1600 lines. With its high sensitivity and built-in image-shake correction and night-mode functions, the unit can record in a wide range of environments.
- This product is compatible with NDI|HX technology of NewTek, Inc.
- The unit supports transmission of video to NewTek NDI compatible software applications and hardware devices over a network.
- When a controller is connected, camera operations can be performed smoothly via IP control or serial control.
- The unit features a night mode that exposes subjects to infrared rays, making it possible to shoot even under low-light conditions.
- When the unit is connected to a personal computer via an IP network, it can be operated via a web browser.
- With a variety of 4K interfaces, there are individual outputs for HD and SDI, so the unit can be used flexibly in a wide range of situations as a 4K-compatible remote camera.
- Connection with a Panasonic camera controller is also possible via Panasonic's proprietary serial communication format.
- The unit is available in white (AW-UE150WP/AW-UE150WE) or black (AW-UE150KP/AW-UE150KE) to suit your intended application and environment.

### Computer requirements

<b>CPU</b>	Intel® Core™ 2 DUO 2.4 GHz or more recommended
<b>Memory</b>	<b>For Windows:</b> 1 GB or more <b>For Mac:</b> 2 GB or more
<b>Network function</b>	100/1000BASE-T or -TX, RJ-45 connector
<b>Image display</b>	Resolution: 1920 × 1080 pixels or more Color generation: True Color 24-bit or more
<b>Supported operating systems and web browsers</b>	<b>For Windows:</b> Microsoft® Windows® 7, 10 Windows® Internet Explorer® 11.0 64-bit/32-bit  Microsoft Edge Chrome
	<b>For Mac:</b> OS X 10.13 Safari 11  OS X 10.12 Safari 10  OS X 10.11 Safari 9  OS X 10.10 Safari 8  Chrome
	<b>For iPhone, iPad, iPod touch:</b> iOS Standard web browsers
	<b>For Android:</b> Android OS Standard web browsers
<b>Other</b>	Adobe® Reader® (for viewing the operating instructions available on the website)

### IMPORTANT

- Failure to provide the required personal computer environment may slow down the delineation of the images on the screen, make it impossible for the web browser to work and cause other kinds of problems.

### <NOTE>

- Depending on the software version of the unit, an update may be necessary.
- Use the desktop version of Internet Explorer. (Internet Explorer for Windows UI is not supported.)
- For the latest information on compatible operating systems and web browsers, visit the support desk at the following website.

<https://pro-av.panasonic.net/>

### Disclaimer of warranty

IN NO EVENT SHALL Panasonic Corporation BE LIABLE TO ANY PARTY OR ANY PERSON, EXCEPT FOR REPLACEMENT OR REASONABLE MAINTENANCE OF THE PRODUCT, FOR THE CASES, INCLUDING BUT NOT LIMITED TO BELOW:

- ① ANY DAMAGE AND LOSS, INCLUDING WITHOUT LIMITATION, DIRECT OR INDIRECT, SPECIAL, CONSEQUENTIAL OR EXEMPLARY, ARISING OUT OF OR RELATING TO THE PRODUCT;
- ② PERSONAL INJURY OR ANY DAMAGE CAUSED BY INAPPROPRIATE USE OR NEGLIGENT OPERATION OF THE USER;
- ③ UNAUTHORIZED DISASSEMBLE, REPAIR OR MODIFICATION OF THE PRODUCT BY THE USER;
- ④ INCONVENIENCE OR ANY LOSS ARISING WHEN IMAGES ARE NOT DISPLAYED, DUE TO ANY REASON OR CAUSE INCLUDING ANY FAILURE OR PROBLEM OF THE PRODUCT;
- ⑤ ANY PROBLEM, CONSEQUENTIAL INCONVENIENCE, OR LOSS OR DAMAGE, ARISING OUT OF THE SYSTEM COMBINED BY THE DEVICES OF THIRD PARTY;
- ⑥ ANY DEMANDS FOR COMPENSATION, CLAIMS, ETC. OCCASIONED BY THE INFRINGEMENT OF PRIVACY BY INDIVIDUALS OR ORGANIZATIONS WHOSE IMAGES WERE SHOT BY THE USER BECAUSE THESE IMAGES (INCLUDING THE RECORDINGS MADE) WERE MADE AVAILABLE BY THE USER BECAUSE IN THE PUBLIC DOMAIN FOR SOME REASON OR OTHER OR BECAUSE THE IMAGES ENDED UP BEING USED FOR PURPOSES OTHER THAN THE ONE DESCRIBED ABOVE;
- ⑦ LOSS OF REGISTERED DATA CAUSED BY ANY FAILURE.

### Network security

As the unit intended to be used while connected to a network, the following security risks exist.

- ① Leakage or theft of information through the unit
- ② Unauthorized operation of the unit by persons with malicious intent
- ③ Interference with or stoppage of the unit by persons with malicious intent

It is your responsibility to take precautions, such as those described below, to protect yourself against the above network security risks.

- Use the unit in a network secured by a firewall, etc.
- If the unit is connected to a network that includes personal computers, make sure that the system is not infected by computer viruses or other malicious programs (using a regularly updated antivirus program, anti-spyware program, etc.).
- Protect your network against unauthorized access by restricting users to those who log in with an authorized user name and password.
- After accessing the unit as an administrator, be sure to close all web browsers.
- Change the administrator password periodically.
- Restrict access to the unit by authenticating the users, for example, to prevent setting information stored on the unit from leaking over the network.
- Do not install the unit in locations where the unit, cables, and other parts can be easily damaged or destroyed by persons with malicious intent.
- Avoid connections that use public lines.

### <NOTE>

#### Notes on user authentication

- User authentication on the unit can be performed via digest authentication or basic authentication. If basic authentication is used without the use of a dedicated authentication device, password leaks may occur. We recommend using digest authentication or host authentication.

#### Usage restrictions

- We recommend connecting the unit, controller, and any computers to the same network segment. Events based on settings inherent to the network devices, for example, may occur in connections that include different segments, so be sure to perform checks prior to operation.

# Features

## ■ Multi-format support

- You can switch between the following formats via the camera menus or a web browser.

### [4K format]

2160/59.94p, 2160/50p, 2160/29.97p\*1, 2160/25p\*1, 2160/24p\*1, 2160/23.98p\*1

### [HD format]

1080/59.94p, 1080/50p, 1080/29.97p\*1, 1080/29.97PsF, 1080/25p\*1, 1080/25PsF, 1080/23.98p\*2, 1080/24p\*1, 1080/23.98p\*1, 1080/23.98PsF, 1080/59.94i, 1080/50i, 720/59.94p, 720/50p

\*1 Native output

\*2 OVER 59.94i output (your monitor may recognize the signal as 59.94i).

\*3 OVER 50i output (your monitor may recognize the signal as 50i).

## ■ 1-type 4K MOS sensor and high-performance 20x zoom lens featured

- A newly developed 1-type 4K MOS sensor and DSP (digital signal processor) are incorporated. High-quality pictures are obtained by video processing in many different kinds of ways.
- In addition to its optical 20x zoom lens, the unit comes with a 10x digital zoom to achieve high-quality images that overflow with ambiance.
- A dynamic range stretcher (DRS) function that compensates for overexposure and loss of dark detail and a digital noise reduction (DNR) function for minimizing image lag even in dark locations and shooting scenes clearly are incorporated to reproduce clean and clear images in a wide range of applications.

## ■ Easy operation of unit enabled by its integration with a high-performance pan-tilt head unit

- Operations at the high speed of 60°/s
- Wide rotational angles with a panning range of ±175° and a tilting range from -30° to 210°
- Quiet operation with noise levels of NC35
- Storage of up to 100 positions in the preset memory (The number of preset memories that can be used varies from one controller to another.)

## ■ Built-in night mode

- The unit supports infrared shooting. By exposing subjects to infrared rays, shooting under ordinarily difficult low-light conditions is possible. (Image output will be in black and white.)
- The iris will be fixed at open.

## ■ IP image output functions

- The unit is equipped with image compression and IP transmission LSI capabilities. Output in 4K quality at up to 60 fps.
- Operation with IP control allows for a wide range of applications, such as controlling the camera from remote locations.

## ■ High degree of compatibility with Panasonic's currently available controllers, enabling a flexible system to be put together

- A maximum of five units can be operated by serial control from one of Panasonic's currently available controllers (AW-RP150). The unit can also be used together with the cameras and pan-tilt head unit systems currently available from Panasonic Corporation so that an existing system can be used to advantage to put together a system that is even more flexible.

### <NOTE>

- It may be necessary to upgrade the version of the controllers other than AW-RP150 in order to support the unit. For details on upgrading, visit the support page on the following website. <https://pro-av.panasonic.net/>  
The maximum distances between the units and controller is 1000 meters (3280 ft). (when serial control is exercised)  
Use of an external device or some other means must be provided separately in order to extend the video signal connections.

## ■ Easy construction of systems thanks to integrated design used for pan-tilt head, camera and lens

- By integrating the camera, lens and pan-tilt head into a single unit, it is now easier to construct systems.

## ■ Use of easy-to-operate wireless remote control (optional accessory) is possible

- A wireless remote control capable of operating up to four units can be used.  
It can easily be used to set the various functions or switch between them while viewing the menu screens.

## ■ Flexible camera layout enabled by simple connection and installation

- This unit features excellent connectivity and installability thanks to the IP control; a lightweight main unit, and the turn-lock mechanism, which enables the user to install it on his or her own (only when used indoors).

### <NOTE>

- Bear in mind that this unit is designed to be used indoors only: It cannot be used outdoors.

## ■ While including a larger 4K lens and pan/tilt mechanism, the unit still has the same installation footprint as previous models.

- The unit maintains the compact installation footprint of previous models.

## ■ Easy connections and settings courtesy of IP control

- Up to a hundred units can be operated by IP connection from a Panasonic controller (AW-RP150).  
(The maximum length of the LAN cables is 100 meters (328 ft).)

## ■ PoE++ \*4 eliminates need for camera power configurations

- Configurations for camera's power supply are not necessary when the unit is connected to a network device that supports the PoE++ standard (IEEE802.3bt compliant)\*5.

### <NOTE>

- The unit does not support software authentication (LLDP communication).
- If the external DC power supply and a PoE++ power supply are connected simultaneously, the external DC power supply will have priority. If the external DC power supply is disconnected while both power supplies are connected, the unit will restart automatically, and the image will be interrupted.
- Use a Category 5e cable or higher when using a PoE++ power supply. The maximum length of the cable between the power supply unit and the unit is 100 meters (328 ft). Using a cable that is lower than Category 5e may result in reduced power supply capabilities.
- When a PoE++ injector is connected to a personal computer that supports Gigabit Ethernet using a straight LAN cable, the personal computer may not recognize the injector in rare cases. In such cases, connect the personal computer to the unit using a LAN cable (or via cross connection).

\*4 Power over Ethernet Plus Plus. Referred to as "PoE++" in this manual.

\*5 For details on PoE++ power supply devices for which operation has been verified, consult your local dealer.

# Controller supported

## ● AW-RP150

### <NOTE>

- The following operations can not be performed via the following controllers.
- **It may be necessary to upgrade the version of the controller in order to support the unit.**

For details on upgrading, visit the support page on the following website.

<https://pro-av.panasonic.net/>

Item	AW-RP120	AW-RP50	AW-HRP200
Camera OSD menu operation			
Scene			
Iris Mode			
Shutter Mode			
Gain			
ND Filter			
Day/Night			
White Balance Mode			
AWB/ABB			
Color Temperature			
R Gain/B Gain			
Pedestal			
R Pedestal/B Pedestal			
Detail			
V Detail Level			
CAM/BAR			
Pan			
Tilt			
Preset			
Preset Speed			
Preset Speed Table			
Preset Scope			
Freeze During Preset			
Focus Mode			
Zoom			
Digital Extender			
OIS			
Tally			

\*1 If the setting value is changed on another device, it may take some time for the setting value to be applied.

\*2 If the Shutter Mode is not turned off/on after configuration, the value will not be changed.

\*3 Improper operation will occur when Gain is set to 19 dB or higher.

\*4 If the setting value is changed on another device, the setting value will not be applied.  
(If the value is configured locally on the device, the value will be applied.)



\*5 The value range display will be incorrect (-150 to +150).

## Accessories

---

Check that the following accessories are present and accounted for.

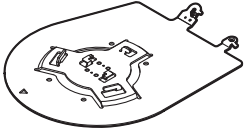
- After removing the product from its container, dispose of the power cable cap (if supplied) and packing materials in an appropriate manner.

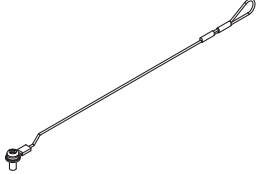
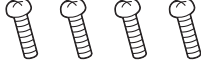
<p><b>Mount bracket for installation surface (Hanging/Desktop) (1)</b></p> 	<p><b>Main unit mounting screw (with flat washer, spring washer) M3×6 mm (1)</b></p> 
<p><b>Drop-prevention wire (1) Drop-prevention wire mounting screw (1) (comes attached to the unit)</b></p> 	<p><b>Bracket mounting screws (bind-head) M4×10 mm (4)</b></p> 

## Optional accessories

---

- Wireless remote controller AW-RM50G (Size “AA” dry battery x 2, obtained separately)
- Direct ceiling mount bracket WV-Q105A
- Fiber module

## Operating precautions

### ■ Shoot under the proper lighting conditions.

To produce pictures with eye-pleasing colors, shoot under the proper lighting conditions.

The pictures may not appear with their proper colors when shooting under fluorescent lights. Select the proper lighting as required.

### ■ To ensure a stable performance in the long term

Using the unit for prolonged periods in locations where the temperature and humidity levels are high will cause its parts to deteriorate, resulting in a reduction of its service life.

(Recommended temperature: Max. 35 °C (95 °F))

Ensure that a cooling unit or heating unit will not blow any air directly toward the installation location.

### ■ Do not point the camera at strong lights.

When parts of the MOS sensor are exposed to spotlights or other strong lights, blooming (a phenomenon where the edges of strong lights become blurred) may occur.

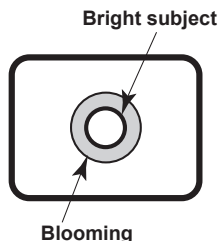

### ■ What happens with high-brightness subjects

Flare may occur if an extremely bright light source is pointed at the lens. In a case like this, change the angle or take some other remedial action.

### ■ When using the automatic functions

- In the [Scene] such as the camera menu, the initial settings on some items has been set to auto, making it impossible for these items to be operated manually. To operate them manually, switch from the auto settings to the manual settings as required.
- When using the ATW (auto tracking white adjustment) function under fluorescent lights, the white balance may vary.
- In some situations, it may be hard to focus at the auto setting. In cases like this, select the manual setting, and focus manually.

### ■ Zooming and focusing

When the focus is set manually, out-of-focusing may occur during zooming.

After zooming, if necessary, either adjust the focus or set the focus to auto.

When using the focus at the manual setting, proceed with zooming after setting the focus position at the Tele end where the focusing accuracy is higher. (However, if the distance from the unit to the subject is less than 1.5 meters (4.92 ft), the subject may shift out of focus at the Wide end.)

If zooming is performed to the Tele end after having adjusted the focus at the Wide end, out-of-focusing may occur.

### ■ Operation of the lens when the power is turned on

When the unit's power is turned on, the zoom, focus and iris are adjusted automatically.

### ■ The unit comes with the safe mode.

The safe mode is function designed to protect the unit from damage. For further details, refer to "Concerning the safe mode" (→ PDF page 133).

### ■ Operating temperature range

Avoid using the unit in cold locations where the temperature drops below 0 °C (32 °F) or hot locations where the temperature rises above 40 °C (104 °F) since these temperatures downgrade the picture quality and adversely affect the internal parts.

### ■ Concerning the MONI OUT signal

It is anticipated that MONI OUT is used in applications such as for outputting images to be cropped from 4K to HD and for monitoring images.

### ■ Concerning the HDMI interface standard

This unit has been certified as HDMI-compatible, but on rare occasions images may not be displayed depending on the HDMI device which has been connected to the unit.

### ■ Color bars

- Color bars are used to adjust the color phase, and the widths and positions of these bars may differ from other models.
- The setting for the "Down CONV. Mode" item when color bars are displayed is fixed at "Squeeze".

### ■ H.264/H.265 patent pool licensing

This product is licensed based on the AVC Patent Portfolio License, and the license does not extend beyond uses by users, who engage in the acts described below, for their own personal and non-profit applications.

- (i) Recording of image information in compliance with the AVC standard (hereafter, "AVC videos")
- (ii) Playing of AVC videos recorded by consumers engaging in personal activities or AVC videos acquired from licensed providers

For details, visit MPEG LA, LLC website (<http://www.mpegla.com>).

### ■ Concerning PoE++ power supply

The unit complies with the IEEE802.3bt standard. Use a compatible Ethernet hub and PoE++ injector to use a PoE++ power supply.

For details on Ethernet hubs and PoE++ injectors for which operations have been verified, consult your local dealer.

- The unit does not support software authentication (LLDP communication).

### ■ Turn off the power before connecting or disconnecting the cables.

This unit is not equipped with a power switch.

Turn off the DC 12 V power supply or PoE++ power supply device before connecting or disconnecting cables.

### ■ Handle the unit carefully.

Do not drop the unit or subject it to strong impact or vibration. Failure to obey may cause the unit to malfunction.

### ■ When the unit is not in use

Turn off the unit's power when it is not in use.

When the unit is no longer going to be used, do not leave it lying around, but be absolutely sure to dispose of it properly.

### ■ Do not touch the optical system parts.

The optical system parts are vital to the operation of the camera. Under no circumstances must they be touched.

In the unlikely event that they have become dusty, remove the dust by using a camera blower or by wiping them gently with a lens cleaning paper.

### ■ Do not point the camera directly at the sun or a laser beam no matter whether it is turned on or not.

Taking images of the sun, laser beams, or other brightly lit subjects for prolonged periods of time may damage the CCD.

### ■ Personal computer used

If the same image is displayed for a prolonged period on a Personal computer's monitor, the monitor may be damaged. Use of a screen saver is recommended.

### ■ Concerning the IP address setting

Do not run the Easy IP Setup Software on a multiple number of personal computers for a single camera and set the IP address at the same time.

Otherwise, you will be unable to complete the proper procedure and set the IP address correctly.

### ■ Do not allow foreign matter to make contact with the rotating parts.

Failure to obey may cause the unit to malfunction.

### ■ Do not get close to the moving parts of the camera head.

Do not put your fingers or body close to the unit while it is in operation. Doing so may result in injury or cause the unit to malfunction.

Furthermore, if the unit hits a person or obstacle, during the panning or tilting operation, the unit will enter into the safe mode.

For further details, refer to the PDF page 133.

### ■ Keep the unit away from water.

Avoid all direct contact with water. Failure to obey may cause the unit to malfunction.

### ■ Maintenance

Turn off the unit's power before proceeding with maintenance.

Failure to obey may result in injuries.

Wipe the surfaces using a soft dry cloth. Avoid all contact with benzine, paint thinners and other volatile substances, and avoid using these substances. Otherwise, the casing may become discolored.

### ■ Do not turn the camera head by hand.

Turning the camera head by hand may cause the unit to malfunction.

### ■ Use the unit in an environment with minimal moisture and dust.

Avoid using the unit in an environment with high concentration of moisture or dust since these conditions will damage the internal parts.

### ■ About the lens/pan-tilt head

If the lens, pan-tilt head, and other parts are not operated for a long period of time, the viscosity of the grease applied inside them may increase and operation may become no longer possible. Move the lens and pan/tilt head regularly.

### ■ About consumables

The following parts are consumables. Replace them using the lifespans as a guide.

The lifespans may vary depending on the operating environment and operating conditions.

The lifespans are a guide for when the unit is used at 35 °C (95 °F).

- Cooling fan: Approx. 15000 hours

Contact your dealer regarding replacements.

### ■ Disposal of the unit

When the unit has reached the end of its service life and is to be disposed of, ask a qualified contractor to dispose of the unit properly in order to protect the environment.

### ■ Information on software used with this product

This product includes GNU General Public License (GPL) and GNU Lesser General Public License (LGPL) licensed software, and the customer is entitled to obtain, modify, or redistribute the source code for the software.

This product includes MIT Licensed software.

This product includes BSD Licensed software.

For details on obtaining the source codes, visit the following website.

<https://panasonic.net/cns/oss/index.html>

However, do not contact Panasonic for questions regarding obtained source codes.

## Wireless remote control (optional accessory)

This unit can be operated by remote control using a wireless remote control (model number: AW-RM50G) purchased separately. Check out the following points before using the wireless remote control.

- Point the wireless remote control at the unit's wireless remote control signal light-sensing area (front panel or back panel), and operate it within a range of 10 meters (32.8 ft) from these areas.
- Refer to <Layout of wireless remote control signal light-sensing areas> on the right.
- The signal sensing distance is reduced if the angle at which the wireless remote control signals are sensed is increased.  
The light-sensing sensitivity is reduced to about one-half when the wireless remote control is pointed at an angle of 40 degrees from each position in front of a wireless remote control signal light-sensing area (front panel or back panel).  
If the remote control is operated from the behind the unit, it may be either difficult or impossible to perform the desired operations.
- If the unit is installed near fluorescent lights, plasma monitors or other such products or if the unit is exposed to sunlight, the effects of the light may make it impossible for the unit to be operated using the wireless remote control.  
Be sure to follow the steps below for installation and use.
  - Take steps to ensure that the wireless remote control signal light-sensing area will not be exposed to the light from fluorescent lights, plasma monitors or other such products or from the sun.
  - Install the unit away from fluorescent lights, plasma monitors and other such products.
- For about 10 minutes even after the batteries have been removed from the wireless remote control, the selection of the operation to be performed (the <CAM1>, <CAM2>, <CAM3> or <CAM4> button which was pressed last) will remain stored in the memory.  
When a longer period of time elapses, however, the selection is reset to the status established when the <CAM1> button was pressed.

### <Layout of wireless remote control signal light-sensing areas>

#### <NOTE>

- The arrows in the figure below show the light-sensing directions in which the wireless remote control signals travel.

Wireless remote control signal light-sensing area (back panel, 1 place)

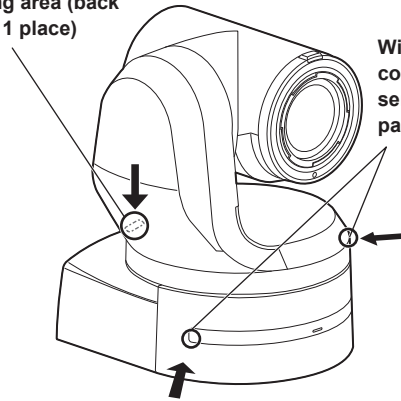

Wireless remote control signal light-sensing area (front panel, 2 places)

#### • Top view

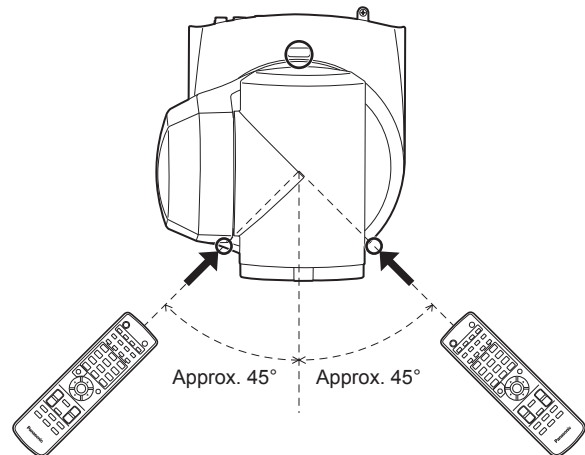

#### • Rear panel view

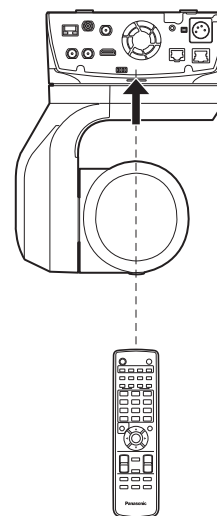



# Parts and their functions

## Camera unit

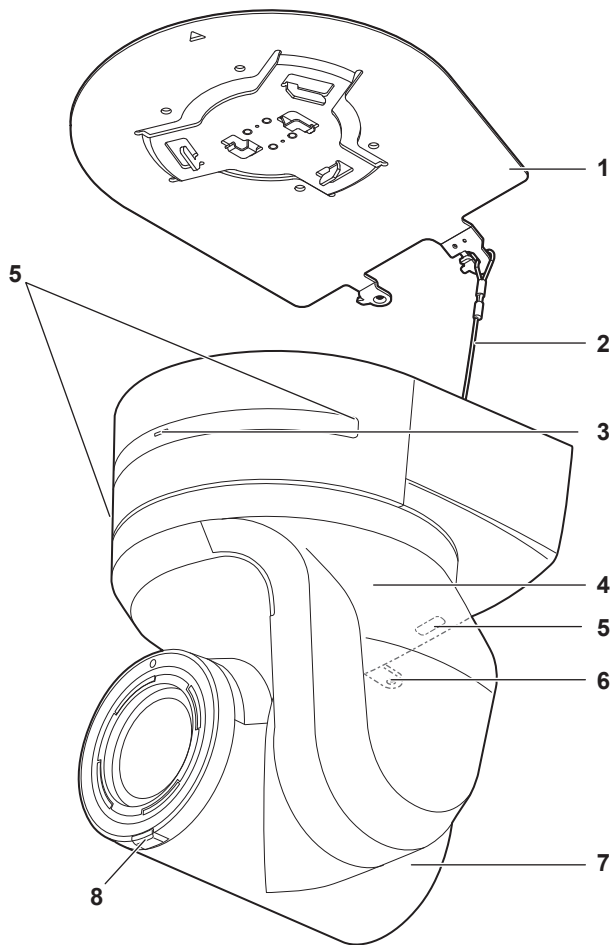

### 1. Mount bracket for installation surface (supplied accessory)

Mount this bracket onto the installation surface, and then attach the camera main unit to the bracket.

### 2. Drop-prevention wire

This wire is screwed down to the bottom panel of the camera main unit. Loop the circle part of the wire around the hook of the mount bracket.

### 3. Status display lamp

This lights in the following way depending on the status of the unit.

**Orange:** When the standby status is established

**Green:** When the power is on

**Red:** When trouble has occurred in the unit

**Green and blinks twice:**

When a signal matched by the remote control ID has been received from the wireless remote control (optional accessory) while the power is on

**Orange and blinks twice:**

When a signal not matched by the remote control ID has been received from the wireless remote control (optional accessory) while the power is on

**Red and blinking:**

Firmware being updated

### 4. Tilt head

This rotates in the right and left direction.

### 5. Wireless remote control signal light-sensing area

The light-sensing area is provided in three places, on the front panel of the camera pedestal and at the top of the rear panel.

### 6. Hole for securing the camera pedestal

This hole is provided in the bottom panel of the camera pedestal.

### 7. Camera head

This rotates in the up and down direction.

### 8. Tally lamp

This comes on or goes off in response to the control from the controller but only when "On" has been selected as the tally lamp use setting. The tally lamp is red or green.

### 9. LAN connector for IP control <LAN LINK/ACT>

This LAN connector (RJ-45) is connected when exercising IP control over the unit from an external device. Use a cable with the following specifications for the connection to this connector.

#### When using a PoE++ Ethernet hub

LAN cable (category 5e or above, straight cable or cross cable), max. 100 m (328 ft)

#### When not using a PoE++ Ethernet hub

LAN cable (category 5 or above, straight cable), max. 100 m (328 ft)

### Rear panel

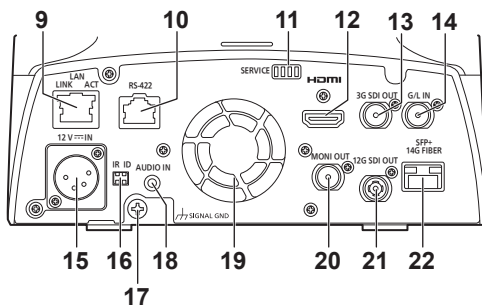

### Bottom panel

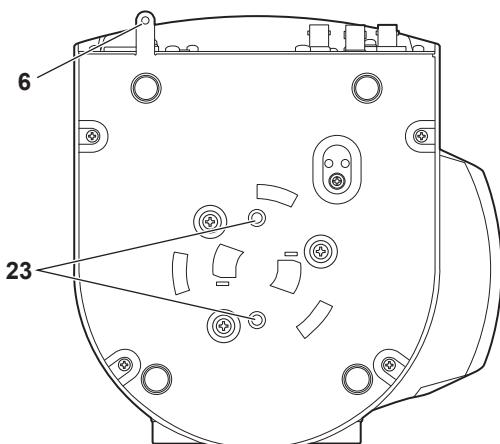

## Parts and their functions (continued)

### 10.RS-422 connector <RS-422>

This RS-422 connector (RJ-45) is connected when exercising serial control over the unit from an external device. Use a cable with the following specifications for the connection to this connector. The red tally lamp can be lit by shorting the R-TALLY signal (pin 2) with GND (pin 1).

#### <NOTE>

- Do not apply a voltage to the TALLY signal pin.
- Menu settings enable the output to pin 7 and pin 8 of the red tally and green tally signals received by the unit. Output is by contact output, and normally is "OPEN", then it becomes "MAKE" for output.

LAN cable\*1 (category 5 or above, straight cable), max. 1000 m (3280 ft)

\*1 Use of an STP (shielded twisted pair) cable is recommended.



Pin No.	Signal	Pin No.	Signal
1	GND	5	TXD+
2	R_TALLY_IN	6	RXD+
3	RXD-	7	OPTION_OUT1
4	TXD-	8	OPTION_OUT2

### ■ Example R\_TALLY\_OUT, G\_TALLY\_OUT connector connections

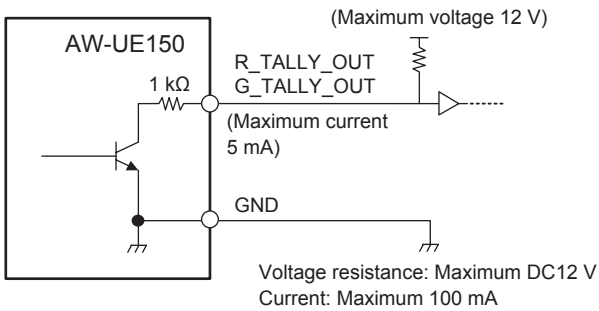

#### • [TRUNK] connector

JEY-9S-1A3F(LF)(SN) (manufactured by Japan Solderless Terminal Mfg. Co., Ltd.)

Pin No.	Function	Signal flow	Remarks
1	TRUNK1_TX (C)	CAM → CCU	RS-422/RS-232C • Selection by menu • Connect to the (C) side with RS-232C connection. (H) side is open.
2	TRUNK1_TX (H)	CAM → CCU	
3	TRUNK1_RX (H)	CCU → CAM	
4	TRUNK1_RX (C)	CCU → CAM	
5	GND		
6	TRUNK2_TX (C)	CAM → CCU	
7	TRUNK2_TX (H)	CAM → CCU	
8	TRUNK2_RX (H)	CCU → CAM	
9	TRUNK2_RX (C)	CCU → CAM	

### 11.Service switches <SERVICE>

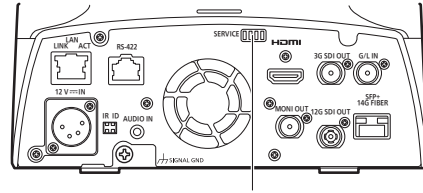

Service switches

	Function	Factory settings
SW1	Switches for initialization (Refer to the explanations in "Initialization 1" and "Initialization 2")	OFF
SW2	Always leave at OFF (used for factory adjustments)	OFF
SW3		OFF
SW4		OFF

#### <NOTE>

- Perform switch settings before turning the unit on.

#### Initialization 1

- Resets the user ID/password for network connections.
- With the IR ID switches and service switches set as shown below, turn on the power of the unit.

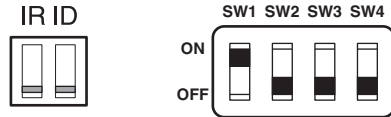

#### Initialization 2

- The unit is reset to the state it was in at the time of purchase. (All camera menu setting values and network setting values are reset.)
- With the IR ID switches and service switches set as shown below, turn on the power of the unit.

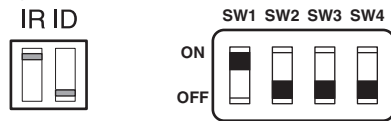

### 12.HDMI connector <HDMI>

This is the HDMI video output connector.

### 13.3G SDI OUT connector <3G SDI OUT>

This is the 3G SDI video signal output connector.

## Parts and their functions (continued)

### 14.G/L IN connector <G/L IN>

This is the external sync signal input connector.

This unit supports BBS (Black Burst Sync) and tri-level synchronization.

Supply to this connector the signals that correspond to the video signal format which has been set.

#### • G/L support format

Frequency: 59.94 Hz, 29.97 Hz, 50 Hz, 25 Hz

✓: supported ×: not supported

System format	REF-IN							
	1080/59i	1080/50i	1080/23PsF	525/59i	625/50i	720/59p	720/50p	
UHD	2160/59.94p	✓	×	×	✓	×	×	×
	2160/29.97p	✓	×	×	✓	×	×	×
	2160/23.98p	×	×	✓	✓	×	×	×
	2160/50p	×	✓	×	×	✓	×	×
	2160/25p	×	✓	×	×	✓	×	×
HD	1080/59.94p	✓	×	×	✓	×	×	×
	1080/59.94i	✓	×	×	✓	×	×	×
	1080/29.97PsF	✓	×	×	✓	×	×	×
	1080/23.98p over 59.94i	✓	×	✓	✓	×	×	×
	480/59.94i	✓	×	×	✓	×	×	×
	1080/23.98PsF	×	×	✓	✓	×	×	×
	720/59.94p	×	×	×	✓	×	✓	×
	1080/50p	×	✓	×	×	✓	×	×
	1080/50i	×	✓	×	×	✓	×	×
	1080/25PsF	×	✓	×	×	✓	×	×
	576/50i	×	✓	×	×	✓	×	×
	720/50p	×	×	×	×	✓	×	✓

Frequency: 24 Hz

Format	External sync signal input format	
	Tri-level sync	
2160/24p	1080/24p	—
1080/24p	1080/24PsF	—

Frequency: 23.98 Hz

Format	External sync signal input format	
	Tri-level sync	
2160/23.98p	1080/23.98p	—
1080/23.98p	1080/23.98PsF	—
1080/23.98PsF	—	—

### 15.DC IN connector <12V===IN> (XLR connector)

Input 10.8 V (12 V–10%) DC.

#### <NOTE>

- Use a DC cable with the following lengths.  
For 12 V input: Max. 3 m (9.84 ft) (when using an AWG16 cable)

#### ■ External DC power supply

Connect after making sure that the output voltage of the external DC power supply is compatible with the rated voltage of the camera. Select an output amperage for the external DC power supply with a margin above the total amperage of the connected devices. The total amperage of connected devices can be calculated with the following formula.

#### Total power consumption ÷ voltage

When the power of the camera is turned on, inrush current is generated. Insufficient power supply when turning on the power may cause a malfunction. We recommend that you use an external DC power supply that can assure double the capacity of the total power consumption of the camera and connected devices that are turned on by interlock when the power of the camera is turned on (such as lenses, wireless microphone receivers).

- Make sure of the pin alignment of the DC output terminal of the external DC power supply and the camera DC IN connector, and connect the polarity correctly. If the +12 V power supply is mistakenly connected to the GND terminal, it may cause fire or malfunction.

12V===IN	
1	GND
2	—
3	—
4	+12V
HA16RA-4P (77) Hirose Electric Co.	

### 16.IR ID switches <IR ID>

CAM1	CAM2	CAM3	CAM4
IR ID	IR ID	IR ID	IR ID

These are used to select the ID of the wireless remote control (optional accessory).

The IR ID switch settings "CAM1" to "CAM4" correspond to the <CAM1> to <CAM4> buttons on the wireless remote control.

### 17.Ground connector

Connects to the ground connector on a wall outlet, ground bar, etc. for grounding. (→ page 7)

### 18.AUDIO IN connector <AUDIO IN>

Inputs external audio (microphone, line).

### 19.Ventilation holes

### 20.MONITOR OUT connector <MONI OUT>

This is an SDI video signal output connector. Use it in applications such as for images being cropped from 4K to HD and for monitoring images.

### 21.12G SDI OUT connector <12G SDI OUT>

This is a 12G-SDI video signal output connector.

### 22.SFP+ Fiber connector <SFP+ 14G FIBER>

This is an optical fiber video signal output connector.

### 23.Tripod screw holes

(Screw: 1/4-20 UNC, ISO 1222 (6.35 mm))

Use these screw holes when securing the unit to a tripod, etc.

## Parts and their functions (continued)

### ■ Output conditions for each video format

Frequency	System Format	HDMI	12G SDI OUT	SFP+ 14G FIBER	3G SDI OUT	MONI OUT
59.94Hz	2160/59.94p	2160/59.94p	2160/59.94p	2160/59.94p	1080/59.94p 1080/59.94i	1080/59.94i
	2160/29.97p	2160/29.97p	2160/29.97p	2160/29.97p	1080/29.97p 1080/29.97PsF	1080/29.97p 1080/29.97PsF
	1080/59.94p	1080/59.94p	1080/59.94p	1080/59.94p	1080/59.94p 1080/59.94i	1080/59.94i
	1080/59.94i	1080/59.94p	1080/59.94i	1080/59.94i	1080/59.94i	1080/59.94i
	1080/29.97p	1080/29.97p	1080/29.97p	1080/29.97p	1080/29.97p	1080/29.97p
	1080/29.97PsF	1080/29.97p	1080/29.97PsF	1080/29.97PsF	1080/29.97PsF	1080/29.97PsF
	1080/23.98p over 59.94i	1080/23.98p	1080/23.98p over 59.94i	1080/23.98p over 59.94i	1080/23.98p over 59.94i	1080/23.98p over 59.94i
720/59.94p	720/59.94p	720/59.94p	720/59.94p	720/59.94p	720/59.94p	
50Hz	2160/50p	2160/50p	2160/50p	2160/50p	1080/50p 1080/50i	1080/50i
	2160/25p	2160/25p	2160/25p	2160/25p	1080/25p 1080/25PsF	1080/25p 1080/25PsF
	1080/50p	1080/50p	1080/50p	1080/50p	1080/50p 1080/50i	1080/50i
	1080/50i	1080/50p	1080/50i	1080/50i	1080/50i	1080/50i
	1080/25p	1080/25p	1080/25p	1080/25p	1080/25p	1080/25p
	1080/25PsF	1080/25p	1080/25PsF	1080/25PsF	1080/25PsF	1080/25PsF
	720/50p	720/50p	720/50p	720/50p	720/50p	720/50p
24Hz	2160/24p	2160/24p	2160/24p	2160/24p	1080/24p	1080/24p
	1080/24p	1080/24p	1080/24p	1080/24p	1080/24p	1080/24p
23.98Hz	2160/23.98p	2160/23.98p	2160/23.98p	2160/23.98p	1080/23.98p 1080/23.98PsF	1080/23.98p 1080/23.98PsF
	1080/23.98p	1080/23.98p	1080/23.98p	1080/23.98p	1080/23.98p	1080/23.98p
	1080/23.98PsF	1080/23.98p	1080/23.98PsF	1080/23.98PsF	1080/23.98PsF	1080/23.98PsF

■ IP video transmission output (multi-channel display)

• When “Streaming mode” is set to “H.265 (UHD)”

Settings		H.265	H.264(1)	H.264(2)	H.264(3)	H.264(4)	JPEG(1)	JPEG(2)	JPEG(3)
Resolution		3840×2160	—	—	—	—	1920×1080 1280×720 640×360 320×180	640×360 320×180	640×360 320×180
Frame rate	59.94Hz	30fps	—	—	—	—	30fps 15fps 5fps 1fps	30fps 15fps 5fps 1fps	30fps 15fps 5fps 1fps
	50Hz	25fps	—	—	—	—	25fps 12.5fps 5fps 1fps	25fps 12.5fps 5fps 1fps	25fps 12.5fps 5fps 1fps
	29.97Hz	30fps	—	—	—	—	30fps 15fps 5fps 1fps	30fps 15fps 5fps 1fps	30fps 15fps 5fps 1fps
	25Hz	25fps	—	—	—	—	25fps 12.5fps 5fps 1fps	25fps 12.5fps 5fps 1fps	25fps 12.5fps 5fps 1fps
	24/23.98Hz	24fps	—	—	—	—	24fps 12fps 4fps 1fps	24fps 12fps 4fps 1fps	24fps 12fps 4fps 1fps

• When “Streaming mode” is set to “H.264”

Settings		H.265	H.264(1)	H.264(2)	H.264(3)	H.264(4)	JPEG(1)	JPEG(2)	JPEG(3)
Resolution		—	1920×1080 1280×720	1920×1080 1280×720 640×360 320×180	1280×720 640×360 320×180	1280×720 640×360 320×180	1920×1080 1280×720 640×360 320×180	640×360 320×180	640×360 320×180
Frame rate	59.94Hz	—	60fps 30fps 15fps 5fps	60fps 30fps 15fps 5fps	30fps 15fps 5fps	30fps 15fps 5fps	30fps 15fps 5fps 1fps	30fps 15fps 5fps 1fps	30fps 15fps 5fps 1fps
	50Hz	—	50fps 25fps 12.5fps 5fps	50fps 25fps 12.5fps 5fps	25fps 12.5fps 5fps	25fps 12.5fps 5fps	25fps 12.5fps 5fps 1fps	25fps 12.5fps 5fps 1fps	25fps 12.5fps 5fps 1fps
	29.97Hz	—	30fps 15fps 5fps	30fps 15fps 5fps	30fps 15fps 5fps	30fps 15fps 5fps	30fps 15fps 5fps 1fps	30fps 15fps 5fps 1fps	30fps 15fps 5fps 1fps
	25Hz	—	25fps 12.5fps 5fps	25fps 12.5fps 5fps	25fps 12.5fps 5fps	25fps 12.5fps 5fps	25fps 12.5fps 5fps 1fps	25fps 12.5fps 5fps 1fps	25fps 12.5fps 5fps 1fps
	24/23.98Hz	—	24fps	24fps	—	—	24fps 12fps 4fps 1fps	24fps 12fps 4fps 1fps	24fps 12fps 4fps 1fps

## Parts and their functions (continued)

• When “Streaming mode” is set to “H.264 (UHD)”

Settings		H.265	H.264(1)	H.264(2)	H.264(3)	H.264(4)	JPEG(1)	JPEG(2)	JPEG(3)
Resolution		—	3840×2160	—	—	—	1920×1080 1280×720 640×360 320×180	640×360 320×180	640×360 320×180
Frame rate	59.94Hz	—	60fps 30fps	—	—	—	30fps 15fps 5fps 1fps	30fps 15fps 5fps 1fps	30fps 15fps 5fps 1fps
	50Hz	—	50fps 25fps	—	—	—	25fps 12.5fps 5fps 1fps	25fps 12.5fps 5fps 1fps	25fps 12.5fps 5fps 1fps
	29.97Hz	—	30fps	—	—	—	30fps 15fps 5fps 1fps	30fps 15fps 5fps 1fps	30fps 15fps 5fps 1fps
	25Hz	—	25fps	—	—	—	25fps 12.5fps 5fps 1fps	25fps 12.5fps 5fps 1fps	25fps 12.5fps 5fps 1fps
	24/23.98Hz	—	24fps	—	—	—	24fps 12fps 4fps 1fps	24fps 12fps 4fps 1fps	24fps 12fps 4fps 1fps

• When “Streaming mode” is set to “JPEG (UHD)”

Settings		H.265	H.264(1)	H.264(2)	H.264(3)	H.264(4)	JPEG(1)	JPEG(2)	JPEG(3)
Resolution		—	1920×1080 1280×720	1920×1080 1280×720 640×360 320×180	1280×720 640×360 320×180	1280×720 640×360 320×180	3840×2160	—	—
Frame rate	59.94Hz	—	60fps 30fps 15fps 5fps	60fps 30fps 15fps 5fps	30fps 15fps 5fps	30fps 15fps 5fps	5fps 1fps	—	—
	50Hz	—	50fps 25fps 12.5fps 5fps	50fps 25fps 12.5fps 5fps	25fps 12.5fps 5fps	25fps 12.5fps 5fps	5fps 1fps	—	—
	29.97Hz	—	30fps 15fps 5fps	30fps 15fps 5fps	30fps 15fps 5fps	30fps 15fps 5fps	5fps 1fps	—	—
	25Hz	—	25fps 12.5fps 5fps	25fps 12.5fps 5fps	25fps 12.5fps 5fps	25fps 12.5fps 5fps	5fps 1fps	—	—
	24/23.98Hz	—	24fps	24fps	—	—	4fps 1fps	—	—

## Parts and their functions (continued)

- When “Streaming mode” is set to “RTMP”

Settings		H.265	H.264(1)	H.264(2)	H.264(3)	H.264(4)	JPEG(1)	JPEG(2)	JPEG(3)
Resolution		—	1920×1080 1280×720	—	—	—	1920×1080 1280×720 640×360 320×180	640×360 320×180	640×360 320×180
Frame rate	59.94Hz	—	60fps 30fps 15fps 5fps	—	—	—	30fps 15fps 5fps 1fps	30fps 15fps 5fps 1fps	30fps 15fps 5fps 1fps
	50Hz	—	50fps 25fps 12.5fps 5fps	—	—	—	25fps 12.5fps 5fps 1fps	25fps 12.5fps 5fps 1fps	25fps 12.5fps 5fps 1fps
	29.97Hz	—	30fps 15fps 5fps	—	—	—	30fps 15fps 5fps 1fps	30fps 15fps 5fps 1fps	30fps 15fps 5fps 1fps
	25Hz	—	25fps 12.5fps 5fps	—	—	—	25fps 12.5fps 5fps 1fps	25fps 12.5fps 5fps 1fps	25fps 12.5fps 5fps 1fps
	24/23.98Hz	—	24fps	—	—	—	24fps 12fps 4fps 1fps	24fps 12fps 4fps 1fps	24fps 12fps 4fps 1fps

- When “Streaming mode” is set to “NDI|HX”

Settings		NDI HX	JPEG(1)
Resolution		1920×1080 1280×720	1280×720 640×360 320×180
Frame rate	59.94Hz	60fps 30fps 15fps 5fps	30fps 15fps 5fps 1fps
	50Hz	50fps 25fps 12.5fps 5fps	25fps 12.5fps 5fps 1fps
	29.97Hz	30fps 15fps 5fps	30fps 15fps 5fps 1fps
	25Hz	25fps 12.5fps 5fps	25fps 12.5fps 5fps 1fps

- It is not possible to select NDI|HX mode when the system frequency is 24/23.98 Hz.

Wireless remote control (not supplied)

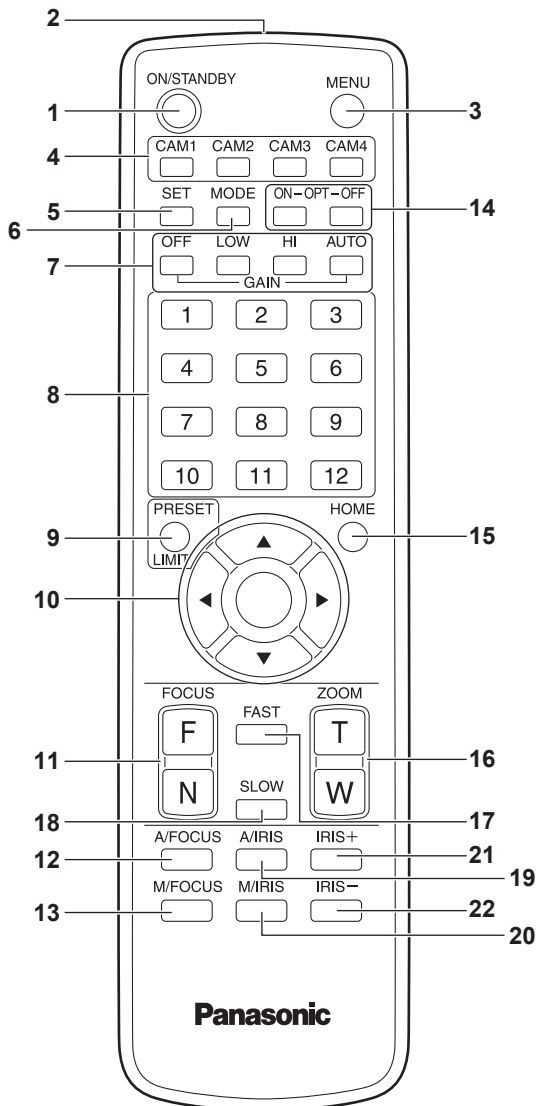

**1. ON/STANDBY button <ON/STANDBY>**

Each time this is pressed for 2 seconds, operation switches between turning on the unit's power and establishing the standby status.

**2. Signal transmission window**

**3. MENU button <MENU>**

Each time this is pressed for 2 seconds, operation switches between displaying the unit's camera menu and exiting the camera menu. When it is pressed quickly (for less than 2 seconds) while a camera menu is displayed, the setting change is canceled. Furthermore, the pan and tilt movement range limits (limiters) are set and released by operating the <PRESET/LIMIT> button and the pan/tilt buttons (<▲> <▼> <◀> <▶>). For details, refer to "Setting/releasing the limiters" (→ page 132).

**4. CAM1 to CAM4 buttons**

<CAM1> <CAM2> <CAM3> <CAM4>

Selects a camera to be operated. Once a button has been selected, the unit corresponding to the selected button can be operated.

**5. SET button <SET>**

If this button is held down for 2 seconds when the [AWB A] memory or [AWB B] memory has been selected for the white balance adjustment, the black balance is adjusted automatically and registered in the memory selected. When this button is pressed for under 2 seconds, only the white balance is adjusted automatically.

**6. MODE button <MODE>**

This is used to select the video signals which are output from the unit. Each time it is pressed, the signals are switched between the color bar signals and camera video signals.

**<NOTE>**

- When [Audio] is set to [On] and the color bar is displayed, a test sound (1 kHz) is output. Be cautious of the volume on external devices.

**7. GAIN button <OFF> <LOW> <HI> <AUTO>**

These are used to set the gain. The gain increase can be set in three steps using the <OFF>, <LOW> and <HI> buttons. <LOW> is set to 9 dB, and <HI> is set to 18 dB. When the <AUTO> button is pressed, the AGC function is activated, and the gain is adjusted automatically depending on the light quantity. The maximum gain of the AGC function can be set using the camera menu.

**8. Preset memory call buttons <1> to <12>**

These are used to call the information on the unit's directions and other settings, which have been registered in the unit's preset memories No.1 to No.12, and reproduce those settings. Settings in preset memories No.13 and above cannot be called from the wireless remote control.

**9. PRESET/LIMIT button <PRESET/LIMIT>**

This is used to register the settings in the preset memories or set or release the limiters. When a preset memory call button is pressed while the <PRESET/LIMIT> button is held down, the information on the unit's current direction and other settings is registered in the call button. Preset memory call buttons <1> to <12> correspond to the unit's No.1 to No.12 preset memories. Furthermore, the pan and tilt movement range limits (limiters) are set and released by operating the <PRESET/LIMIT> button, <MENU> button and the pan/tilt buttons (<▲> <▼> <◀> <▶>). For details, refer to "Setting/releasing the limiters" (→ page 132).

**10. Pan-tilt buttons and menu operation buttons**

<▲> <▼> <◀> <▶> <○>

- 1) These are used to change the unit's direction. The unit is tilted in the up/down direction using the <▲> and <▼> buttons and panned in the left/right direction using the <◀> and <▶> buttons. The <○> button does not work during tilting and panning. When the <▲> or <▼> and <◀> or <▶> buttons are pressed at the same time, the unit moves diagonally.
- 2) The buttons are used for menu operations when the unit displays the camera menus. Use the <▲>, <▼> (<◀>, <▶>) buttons to select the menu items. When a selected item has a sub-menu, the sub-menu will be displayed by pressing the <○> button. When the cursor is aligned with a particular item and the <○> button is pressed on the setting menu at the bottom hierarchical level, the setting of the selected item blinks. When the <○> button is pressed after the setting has been changed using the <▲> and <▼> (<◀> and <▶>) buttons, the setting stops blinking, and the new setting is entered. A setting for a regular menu item is reflected immediately if it is changed while it is still flashing. If the <MENU> button is pressed quickly (for less than 2 seconds) while the setting is in the blinking status, the change will be canceled, and the setting selected prior to the change will be restored.



## Parts and their functions (continued)

---

### <NOTE>

- To prevent malfunctioning, there are a number of menu items ([Scene], [Format] and [Frequency]) whose setting is not reflected immediately even if it is changed while it is still flashing. It is reflected only after the <O> button has been pressed, causing the setting to stop flashing and the new setting to be entered.
- A confirmation screen appears before the settings of some menu items are to be entered.

### 11.FOCUS button <F> <N>

These are used to adjust the lens focus manually when the manual setting is established for the lens focus.

The focus is adjusted in the far using the <F> button and in the near using the <N> button.

### 12.A/FOCUS button <A/FOCUS>

This is used when automatically adjusting the lens focus.

### 13.M/FOCUS button <M/FOCUS>

This is used when manually adjusting the lens focus.

The FOCUS buttons (<F> and <N>) are used when performing the actual adjustment.

### 14.OPT button <ON> <OFF>

Turn night mode on/off.

#### <NOTE>

- In night mode, video output will be in black and white. In addition, the iris will be forcibly opened.
- White balance adjustment is not possible in night mode.
- ND filter switching is not possible in night mode.

### 15.HOME button <HOME>

When this is pressed for 2 seconds, the unit's direction (panning or tilting) returns to the reference position.

### 16.ZOOM button <T> <W>

These are used to adjust the lens zoom.

The zoom is adjusted in the wide-angle using the <W> button and in the telephoto using the <T> button.

### 17.FAST button <FAST>

This is used to change the movement speed at which the panning, tilting, zooming and focusing operations are performed to the high speed.

#### <NOTE>

- The operating speed for panning and tilting when the preset memory settings have been called can be changed using the "Preset Speed" item of the camera menu.

### 18.SLOW button <SLOW>

This is used to change the movement speed at which the panning, tilting, zooming and focusing operations are performed to the low speed.

### 19.A/IRIS button <A/IRIS>

This establishes the setting for adjusting the lens iris automatically in line with the light quantity.

### 20.M/IRIS button <M/IRIS>

This establishes the setting for adjusting the lens iris manually.

The <IRIS +> and <IRIS -> buttons are used when performing the actual adjustment.

### 21.IRIS + button <IRIS +>

This is used to adjust the lens iris in the opening direction.

### 22.IRIS - button <IRIS ->

This is used to adjust the lens iris in the closing direction.

## Setting the remote control IDs

The wireless remote control (optional accessory) is capable of operating up to four units.

IDs are used to set which units are selected when the <CAM1>, <CAM2>, <CAM3> and <CAM4> buttons on the wireless remote control have been pressed.

- When operating a multiple number of these units using wireless remote controls, set a different remote control ID for each control.
- When using one unit, set the remote control ID to “CAM1” unless the setting needs to be changed.

### ■ Setting procedure

Operate the IR ID switches on the unit's rear panel, and select “CAM1”, “CAM2”, “CAM3” or “CAM4” as the remote control ID. (→ page 19)

The IR ID switch settings “CAM1” to “CAM4” correspond to the <CAM1> to <CAM4> buttons on the wireless remote control.

(The factory setting is “CAM1”.)

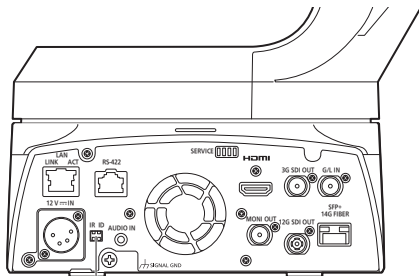

IR ID switches

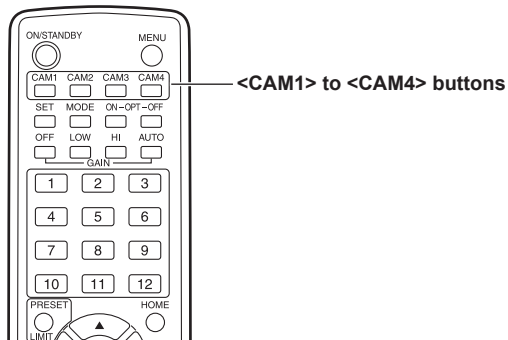

<CAM1> to <CAM4> buttons

# Network settings

## Use the Easy IP Setup Software to establish the unit's settings

The settings related to the unit's network can be established using the Easy IP Setup Software.

You can obtain Easy IP Setup Software (EasyIPSetup.exe) by downloading it from the following website.

<https://pro-av.panasonic.net/>

To establish the settings for a multiple number of units, the settings must be selected for each camera involved.

If the settings cannot be established using the Easy IP Setup Software, select the settings separately for the unit and personal computer on the Network setup screen [Network] of the setting menu. (→ page 110)

### <NOTE>

- If, after the network settings have been established, another device in the same network has the same IP address, the network operations will not be performed properly.  
Set the IP address in such a way that it does not duplicate an existing IP address.
- Do not establish network settings from a multiple number of Easy IP Setup Software programs at the same time for a single camera. Similarly, do not perform the "Auto IP setting" operation of the AW-RP150 remote camera controller at the same time. The IP address settings may no longer be recognized as a result.
- The Easy IP Setup Software cannot be used from a different subnet via a router.
- Use Easy IP Setup Software ver. 4.25R00 or newer.

### 1. Start the Easy IP Setup Software.

### 2. Click the [Search] button.

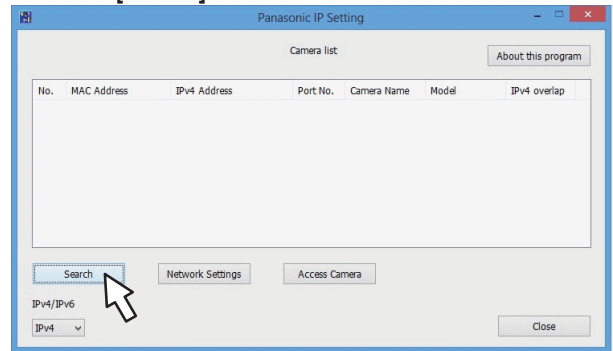

### 3. Click the MAC address/IPv4 address of the camera to be set, and click the [Network Settings] button.

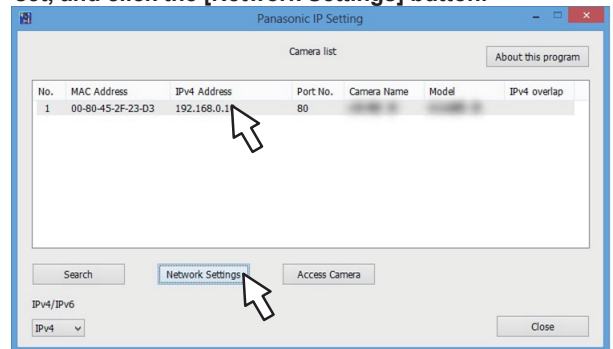

### <NOTE>

- When a DHCP server is being used, the IP address allocated to the unit can be checked by clicking the [Search] button of the Easy IP Setup Software.
- If the same IP address is used for any additional cameras, the numbers of the additional cameras will be displayed in the [IPv4 overlap] column of the cameras concerned.
- When the [Access Camera] button is clicked, the Live screen of the selected camera is displayed.
- This unit does not support an IPv4/IPv6 switching function.

### 4. Input the network items, and click the [Save] button.

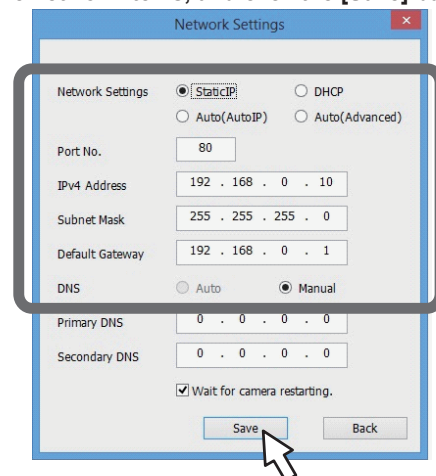

### <NOTE>

- When a DHCP server is being used, [DNS] of the Easy IP Setup Software can be set to [Auto].
- After the [Save] button is clicked, it takes about 2 minutes for the settings in the unit to be completed. If the external DC power supply or LAN cable is disconnected before the settings are completed, the settings will be canceled. In this case, repeat the steps to establish the settings.
- When a firewall (including software) has been introduced, enable access to all the UDP ports.

## Setting the remote control IDs (continued)

### Installing the plug-in viewer software

To view IP images from the unit on a web browser, the "Network Camera View 4S" plug-in viewer software (ActiveX®) must be installed. The plug-in viewer software can be installed directly from the unit.

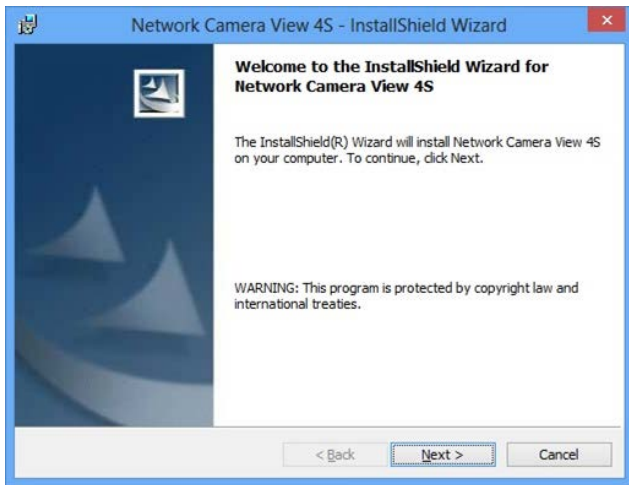

#### <NOTE>

- [Automatic installation of viewer software] is set to [On] at the time of purchase, allowing you to install directly from the unit. If a message appears in the web browser's information bar, see page 142.
- When you display the Live screen [Live] on the personal computer for the first time, the installation screen for the plug-in viewer software (ActiveX) appears. Follow the instructions on the screen to perform installation. (only when using Windows Internet Explorer 11)
- If the plug-in viewer software (ActiveX) installation screen continues to appear when switching screens, even after it is installed, restart the personal computer.
- A license is required for the plug-in viewer software for each personal computer on which it is installed. You can view the number of times the plug-in viewer software was automatically installed in the [Product info.] tab of the Maintenance screen [Maintenance] (→ page 122). For details on licenses, consult your local dealer.
- To uninstall the plug-in viewer software, select [Control Panel] - [Programs] - [Uninstall a program] in Windows, and remove "Network Camera View 4S".

### User authentication

The unit can be configured to allow **access from the internet**. To prevent infringement of privacy and personality rights, information leaks, and other issues concerning **unauthorized access by third parties**, we recommend enabling the user authentication function upon installation. We also recommend using DIGEST authentication when connecting to a device that supports DIGEST authentication.

Preparation:

1. Startup the web browser and display the "Live" page on a PC.
2. Click "Setup" button and then click "User mng." button.

The user authentication window will be displayed.

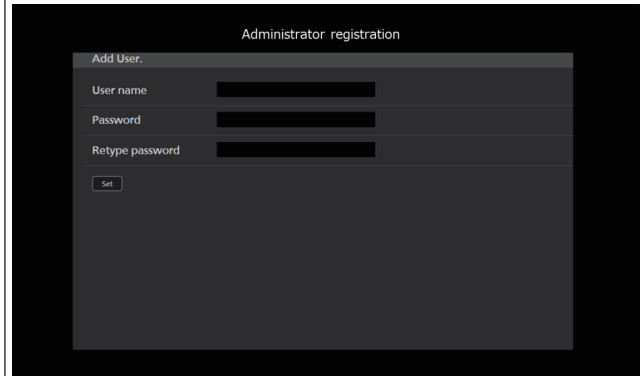

#### ① Select "On" for "User auth."

- \* Set to "Off" by default.
- ⇒ Then click "Set" button.

#### ② (When using a device that supports DIGEST authentication)

##### Select "Digest" for "Authentication".

- ⇒ Then click "Set" button.

#### ③ Register a new user name and password.

- \* Select "1. Administrator" for the access level.
- ⇒ Then click "Set" button.

#### ④ Delete the default user name.

- ⇒ Click the "Delete" button after selecting the user name to be deleted ("admin[1]").

\* Depending on the model used, the screens shown in the explanations may differ to the actual camera screens.

### User name and password management

- **Use a combination of characters and numbers that is difficult to guess.**  
Avoid using a string of the same characters, such as "11111", birth dates, or telephone numbers.  
For details on valid characters and lengths, refer to "User authentication screen" (→ page 107).
- **Change user names and passwords periodically.**
- **Make sure to manage the configured user names and passwords.**
- **Delete all user names that do not have an assigned user.**

### After changing the user name/password

Also change the user names and passwords registered to the following. Refer to the operating instructions provided with your camera for further information about the settings used for your camera.

- Remote camera controller (AW-RP150)
- Browsers and applications on computers, tablets, and smartphones.

# Basic shooting operations

1. Set the subject brightness to the appropriate level.
2. Turn on the power of all the units and devices in the system.

3. Select the unit to be operated.

Even when using only one unit, it must still be selected from the wireless remote control or controller.

4. Select the shooting mode.

One of four shooting modes (Scene1, Scene2, Scene3 or Scene4) — whichever one will best suit the shooting conditions — can be selected.

The shooting modes are set by the user.

For details of the factory settings, refer to pages 66 to 71.

Select the mode that satisfies the shooting conditions and suits your preferences.

When continuing to shoot in the same circumstances, there is no need to select another mode.

5. Start shooting.

(After shooting, turn off the power of all the units and devices in the system.)

<NOTE>

- Some of the initial settings are auto settings and cannot be operated manually. To operate them manually, switch from the auto settings to the manual settings as required.

If the settings have already been changed and the original settings are to be restored, refer to the “What to do when encountering problems in the basic shooting operations” (→ page 33) and “Camera screen” (→ page 43) in “Camera menu items”.

## How to turn the power on and off

### Turning the power on

#### When performing operations from a wireless remote control

1. Set all the power switches of the units and devices connected in the system to ON.

- This unit does not have a power switch.

When power is supplied to it, the status display lamp will light orange, and the unit is set to the Standby mode.

<NOTE>

- Under factory default conditions, the unit will be in Standby mode when power is supplied for the first time. (Status display lamp: Lit orange)
- When the power supply is cut off while the unit is in Standby mode, the unit will be in Standby mode the next time power is supplied. (Status display lamp: Lit orange)
- When the power supply is cut off while the unit is in Power ON mode, the unit will be in Power ON mode the next time power is supplied. (Status display lamp: Lit green)

2. Press one of the <CAM1> to <CAM4> buttons on the wireless remote control to select the unit.

3. Press the <ON/STANDBY> button on the wireless remote control for about 2 seconds.

The Power ON mode is established, images are output, and control can be exercised.

- The unit's status display lamp now lights up green.

<NOTE>

- It takes maximum 30 seconds per unit for the initial settings operation to be completed. During this period, the unit cannot be operated. (Status display lamp: Lit orange)

4. If a multiple number of units are going to be used, repeat steps 2 and 3 as required.

The unit's status display lamp blinks green when a signal matched by the remote control ID has been received, and it blinks orange when a signal that is not matched by the remote control ID has been received.

<NOTE>

- When operation is transferred to the Standby mode: The current zoom, focus and iris positions are stored in the memory (Power ON preset).
- When operation is transferred to the Power ON mode: The zoom, focus and iris are adjusted to the positions which were stored in the memory (Power ON preset) when operation was transferred to the Standby mode.

### When performing operations from a controller

#### When using an AW-RP150

Refer to the operating instructions for the controller.

#### When using a commercially available controller

Refer to the operating instructions for the controller.

### Turning the power off

#### When performing operations from a wireless remote control

1. Press one of the <CAM1> to <CAM4> buttons on the wireless remote control to select the unit.

2. Press the <ON/STANDBY> button on the wireless remote control for about 2 seconds.

The unit enters Standby mode.

- The unit's status display lamp now lights up orange.

3. If a multiple number of units are going to be used, repeat steps 1 and 2 as required.

4. Set all the power switches of the units and devices connected in the system to OFF.

- This unit does not have a power switch.

<NOTE>

- When operation is transferred to the Standby mode: The current zoom, focus and iris positions are stored in the memory (Power ON preset).
- When operation is transferred to the Power ON mode: The zoom, focus and iris are adjusted to the positions which were stored in the memory (Power ON preset) when operation was transferred to the Standby mode.

### When performing operations from a controller

#### When using an AW-RP150

Refer to the operating instructions for the controller.

#### When using a commercially available controller

Refer to the operating instructions for the controller.

## Selecting the units

---

Up to four units can be operated using one wireless remote control.

Up to five units can be operated using one controller.

Select the unit (or units) to be operated from the wireless remote control or controller.

Even when using only one unit, it must still be selected.

### When performing operations from a wireless remote control

---

To select the unit using the wireless remote control, the IR ID switches on the unit's back panel must be set.

For details of the IR ID switch settings, refer to page 19 and page 26.

#### 1. Press the <CAM1>, <CAM2>, <CAM3>, or <CAM4> button.

The unit's status display lamp blinks green when a signal matched by the remote control ID has been received, and it blinks orange when a signal that is not matched by the remote control ID has been received.

### When performing operations from a controller

---

#### When using an AW-RP150

Refer to the operating instructions for the controller.

# Selecting the shooting modes (scene files)

## Types of shooting modes

One of four shooting modes (Scene1, Scene2, Scene3 or Scene4) — whichever one will best suit the shooting conditions — can be selected. The shooting modes are set by the user.

For details of the factory settings, refer to pages 66 to 71.

Select the mode that satisfies the shooting conditions and suits your preferences.

The settings can be changed by menu operations.

- The results of the white balance and other adjustments are stored in the memory separately by shooting mode. Be absolutely sure to select the shooting mode before making any adjustments.

### <NOTE>

- Some of the initial settings are auto settings and cannot be operated manually. To operate them manually, switch from the auto settings to the manual settings as required.

[Scene1]

[Scene2]

[Scene3]

[Scene4]

The settings of your preferences can be established in line with the shooting scene, lighting and other conditions.

## How to select the shooting mode

### When performing operations from a wireless remote control

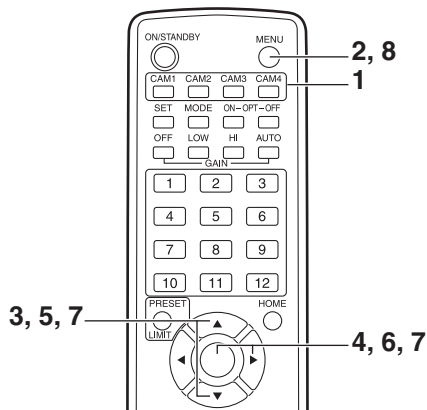

1. Press the <CAM1>, <CAM2>, <CAM3> or <CAM4> button to select the unit.

2. Press and hold the <MENU> button for about 2 seconds. The Top Menu is displayed.

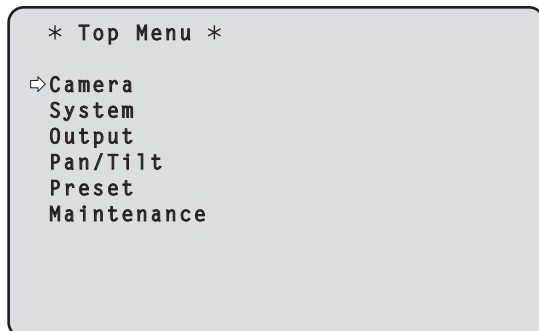

3. Press the <▲> or <▼> button to bring the cursor to [Camera].

4. Press the <○> button.

The [Camera] menu is displayed on the monitor.

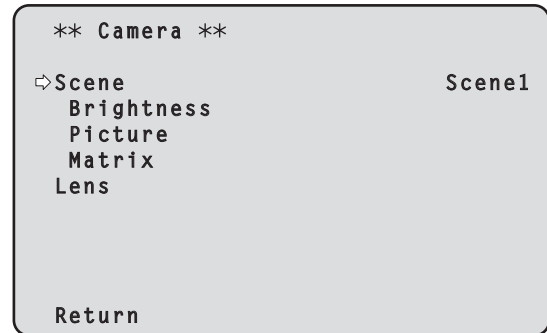

5. Press the <▲> or <▼> button to bring the cursor to [Scene].

6. Press the <○> button.

The shooting mode blinks.

7. Press the <▲> or <▼> button to select the shooting mode (Scene1, Scene2, Scene3 or Scene4) to be used, and press the <○> button to enter the selection.

8. Press and hold the <MENU> button for about 2 seconds.

The camera menu display is exited.

### When performing operations from a controller

#### When using an AW-RP150

Refer to the operating instructions for the controller.

# Shooting

## When performing operations from a wireless remote control

### ■ Changing the camera's direction

#### Moving the camera toward the left or right (panning):

Press the <◀> or <▶> button.

#### Moving the camera up or down (tilting):

Press the <▲> or <▼> button.

#### Moving the camera diagonally:

Press the <▲> or <▼> button and <◀> or <▶> button at the same time.

#### Returning the camera to the reference position:

Press the <HOME> button for about 2 seconds.

### ■ Using the zoom function

#### Zooming in (the subject becomes magnified in size):

Press the <T> button of <ZOOM>.

#### Zooming out (the subject becomes reduced in size):

Press the <W> button of <ZOOM>.

### ■ Switching the panning/tilting and lens operation speed

#### Changing the direction or zoom at high speed:

Press the <FAST> button.

#### Changing the direction or zoom at low speed:

Press the <SLOW> button.

The speeds at which the pan, tilt, zoom, focus and iris are controlled are now switched.

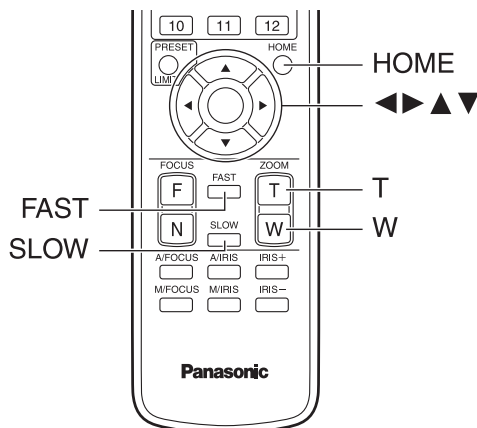

## When performing operations from a controller

### ■ Changing the camera's direction

#### Moving the camera toward the left or right (panning):

Tilt the <PAN/TILT> lever toward L or R.

#### Moving the camera up or down (tilting):

Tilt the <PAN/TILT> lever toward UP or DOWN.

#### Moving the camera diagonally:

Tilt the <PAN/TILT> lever diagonally.

### ■ Using the zoom function

#### Zooming in (the subject becomes magnified in size):

Tilt the <ZOOM> lever toward the TELE direction.

#### Zooming out (the subject becomes reduced in size):

Tilt the <ZOOM> lever toward the WIDE direction.

### ■ Switching the panning/tilting and lens operation speed

#### When using an AW-RP150

Refer to the operating instructions for the controller.



# What to do when encountering problems in the basic shooting operations

---

If the trouble is not resolved by taking the action suggested below, refer to "Troubleshooting" (→ page 134).

## When performing operations from a wireless remote control

---

### The unit does not move.

- Press the <CAM1>, <CAM2>, <CAM3> or <CAM4> button to select the unit which is to be operated.  
If only one unit is being used, it is normally selected using the <CAM1> button.
- Check that the IR ID switches have been set correctly. (→ page 19, page 26)
- If the unit's status display lamp is off or lights up orange, it means that the unit's power is not on.  
Refer to "Turning the power on" (→ page 29), and turn on the power.
- If the unit's status display lamp does not blink even when the wireless remote control is operated near the unit's wireless remote control signal light-sensing area, it means that the wireless remote control's batteries have run down.  
Replace the batteries.

### Multiple color bands (color bars) are displayed.

Switch to the camera image by pressing the <MODE> button.

### The menu screen is displayed.

Press the <MENU> button for 2 seconds to exit the camera menu.

### The lens focus is not adjusted automatically.

Press the <A/FOCUS> button to switch to auto focusing.

### The camera picture is too light or too dark.

- Press the <A/IRIS> button to switch the lens iris adjustment to auto.
- Press the <AUTO> button of <GAIN> to switch the gain adjustment to auto.

### Something is wrong with the coloring of the camera pictures.

Refer to "Auto tracking white adjustment (ATW)" (→ page 37), and switch to [ATW].

### The camera menus are not displayed.

Restart the camera and open any of the camera menus within about a minute, the menus will be displayed in all the outputs.

Check [OSD Mix] (→ page 58) on the camera menu [Output 4/6] screen.

## When performing operations from a controller

---

### The unit does not move.

- Select the unit to be operated by following the procedure below.  
**When using an AW-RP150**  
Refer to the operating instructions for the controller.

- If the unit's status display lamp is off or lights up orange, it means that the unit's power is not on.  
Refer to "Turning the power on" (→ page 29), and turn on the power.

### Multiple color bands (color bars) are displayed.

Switch to the camera image by pressing the <BARS> button.

### The menu screen is displayed.

Press the <CAMERA OSD> button to exit the camera menu.

### The lens focus is not adjusted automatically.

Press the <AUTO> button of <FOCUS> to switch to auto focusing.

### The camera picture is too light or too dark.

- Press the <AUTO> button of <IRIS> to switch the lens iris adjustment to auto.
- Press the <AUTO> button of <GAIN> to switch the gain adjustment to auto.

### Something is wrong with the coloring of the camera pictures.

Refer to "Auto tracking white adjustment (ATW)" (→ page 37), and switch to [ATW].

### The camera menus are not displayed.

Restart the camera and open any of the camera menus within about a minute, the menus will be displayed in all the outputs.

Check [OSD Mix] (→ page 58) on the camera menu [Output 4/6] screen.

## More advanced operations

---

### Manual shooting (→ page 34)

- Manually adjusting the focus
- Manually adjusting the iris
- Manually adjusting the shutter speed
- Manually adjusting the gain

### Preset memories (→ page 35)

- Up to 100 settings for the camera direction (panning and tilting), zoom, focus, iris, gain up and white balance can be registered in the preset memories, and called.
- The number of settings that can be registered and called depends on the type of wireless remote control (12 settings) or controller that is used for operation.

### White balance adjustment (→ pages 36 to 37)

- This adjustment is performed to express the white accurately. Its setting also has an effect on the color tones of the entire screen.
- It must be performed when using the unit for the first time or when the unit has not been used for a prolonged period.
- Perform adjustment when the lighting conditions or brightness changes.
- Once the white balance has been attained, no further adjustment is required provided that the unit is going to be used under the same conditions.
- White balance adjustment is not possible in night mode.

### Black balance adjustment (→ page 38)

- This adjustment is performed to express the black accurately. Its setting also has an effect on the color tones of the entire screen.
- It must be performed when using the unit for the first time or when the unit has not been used for a prolonged period.
- It must be performed when the ambient temperature has changed significantly and at the change of the seasons.
- Once the black balance has been attained, no further adjustment is required provided that the unit is going to be used under the same conditions.

### Black level (master pedestal) adjustment (→ page 39)

- This adjustment is performed to align the black level (pedestal level) of a multiple number of cameras.
- Ask your dealer to perform this adjustment.

### Genlock adjustment (→ page 40)

- This adjustment is performed to achieve phase alignment by applying external synchronization (genlock) when a multiple number of cameras will be used or when the unit will be used in combination with other devices.
- Ask your dealer to perform this adjustment.

# Manual shooting

## Manually adjusting the focus

The lens focus can be adjusted manually.

### When performing operations from a wireless remote control

1. Press the **<M/FOCUS>** button to switch the focus to manual adjustment.
2. Press the **<F>** or **<N>** button of **<FOCUS>** to adjust the focus.  
When the **<F>** button is pressed, the focus moves further away (far); conversely, when the **<N>** button is pressed, it moves nearer (near). The speed of focusing and other adjustments can be switched to fast or slow by pressing the **<FAST>** or **<SLOW>** button, respectively.
3. If necessary, press the **<A/FOCUS>** button to return the focus to the automatic adjustment.

### When performing operations from a controller

#### When using an AW-RP150

Refer to the operating instructions for the controller.

#### <NOTE>

- When the focus is set to manual, the subject may go out of focus during panning, tilting and zooming. Therefore, the unit comes with a function which compensates for this. (Focus Adjust With PTZ.) This function was set to [On] at the factory. If the function has been set to [Off], either adjust the focus, as required, after zooming or set the focus to auto. (→ page 60, page 85, page 88, page 106)

## Manually adjusting the iris

The lens iris can be adjusted manually.

### When performing operations from a wireless remote control

1. Press the **<M/IRIS>** button to switch the iris to manual adjustment.
2. Press the **<IRIS +>** or **<IRIS ->** button to adjust the iris.  
Press the **<IRIS +>** button to adjust the lens iris in the opening direction; conversely, press the **<IRIS ->** button to adjust the lens iris in the closing direction.  
The speed of the iris and other adjustments can be switched to fast or slow by pressing the **<FAST>** or **<SLOW>** button, respectively.
3. If necessary, press the **<A/IRIS>** button to return the iris to the automatic adjustment.

### When performing operations from a controller

#### When using an AW-RP150

Refer to the operating instructions for the controller.

#### <NOTE>

- In the night mode, the iris is set to open as a measure to prevent video spying.  
Adjust the brightness at the light source.

## Manually adjusting the shutter speed

The shutter speed can be set using two methods. One is a method that specifies the time (where a time such as 1/250 sec. is designated), and the other is a method that specifies the frequency (where synchro scan, 60.15 Hz, etc. is designated).

When shooting a TV screen or personal computer's monitor screen, the horizontal noise generated when the screen is shot can be minimized by adjusting the frequency to the screen frequency using synchro scan.

### When performing operations from a wireless remote control

Perform the adjustments on the Camera menu.

For further details, refer to the [Shutter Mode] (→ page 44) and [Step/Synchro] (→ page 44).

### When performing operations from a controller

#### When using an AW-RP150

Refer to the operating instructions for the controller.

## Manually adjusting the gain

There are two ways to adjust the gain. One way involves using the buttons on the wireless remote control or controller; the other way involves using the Camera menu or Web setup screen [Setup]. The gain can be adjusted more precisely using the Camera menu or Web setup screen [Setup].

For further details, refer to the [Gain] (→ page 44, page 97).

#### <NOTE>

- When adjusting the gain, the light quantity may change suddenly (causing the image output to be subjected to a shock).

### When performing operations from a wireless remote control

1. Press one of the **<GAIN>** buttons (**<OFF>**, **<LOW>** or **<HI>**).  
These buttons enable the gain increase to be selected in three steps. The **<LOW>** button is used to select 9 dB; the **<HI>** button is used to select 18 dB.
2. If necessary, press the **[AUTO]** button of **<Gain>** in order to return the gain to the automatic adjustment (AGC).

### When performing operations from a controller

#### When using an AW-RP150

Refer to the operating instructions for the controller.

In any case, the maximum gain of the automatic adjustment (AGC) can be set by the camera menu or Web setup screen [Setup].  
For further details, refer to the [AGC Max Gain] (→ page 44, page 97).

## Preset memories

---

This unit enables up to 100 settings for the camera direction (panning and tilting), zoom, focus, iris, gain and white balance to be registered in its preset memories, and called.

However, the number of settings that can be registered and called depends on the type of wireless remote control or controller that is used for operation.

- The focus and iris operating modes (manual and auto settings) are neither registered nor recalled. The current focus and iris values are registered.
- The focus and iris values can be recalled only when the manual settings are applicable.
- For the white balance, the current White Balance Mode adjustment values are registered. If a preset value is recalled when AWB A or AWB B is selected, the adjustment value selected when it was registered as a preset will be recalled. The R Gain and B Gain values return to 0 in such cases.

### <NOTE>

- When there is a large difference in the environmental temperature between the time of registration and the time the setting is called, displacement of the preset position may occur.
- If displacement occurs, perform registration again.
- When a manual operation is performed for pan, tilt, zoom, focus or iris during preset recall, the preset operation for the pan, tilt, zoom, focus or iris operation concerned will be aborted.
- If another preset has been recalled during an ongoing preset recall, the preset being recalled is aborted, and operation for the preset called last is performed instead.

## When performing operations from a wireless remote control

---

Twelve settings (preset No.1 to No.12) can be registered and called using the wireless remote control.

The <1> to <12> buttons correspond to the unit's preset memories No.1 to No.12.

### ■ Registering the settings in the preset memories

#### 1. Display the picture to be shot on the monitor.

Operate the pan, tilt or zoom buttons to determine the camera angle. Adjust the focus, iris, gain and white balance if they need to be adjusted.

#### 2. While holding down the <PRESET> button, press the button corresponding to the preset memory number.

- If a preset memory number with an already registered setting has been selected, the existing setting will be erased and replaced with the new one.

### ■ Calling the settings of the preset memories

#### 1. Press the button in which the preset memory setting has been registered.

## When performing operations from a controller

---

### When using an AW-RP150

Up to 100 entries can be registered/recalled.

For details, refer to the operating instructions for the controller.

# White balance adjustment

Adjust the ratio between the three primary colors (RGB) to reproduce white accurately. If the white balance is out of adjustment, not only will white be reproduced poorly, but the color tones of the screen as a whole will also be degraded.

- Perform adjustment when using the unit for the first time or when the unit has not been used for a prolonged period.
- Perform adjustment when the lighting conditions or brightness changes.

Either "AWB" (automatic white balance adjustment) which initiates automatic adjustment when the <AWB> button on the controller has been pressed or "ATW" (automatic tracking white balance adjustment) which constantly adjusts the white balance can be selected for adjustment purposes.

The results of the AWB adjustment can be stored in two memories, A and B, when [AWB A] or [AWB B] has been selected for the white balance.

- Once the white balance values have been adjusted, their setup procedure will be completed simply by selecting them using the camera menus or Web setup screen [Setup], or by pressing the buttons on the controller, provided that they are going to be used under the same conditions as the ones established when the values were set. There is no need to set it again.
- Once a new setting is entered, the previous setting will be erased.
- White balance adjustment is not possible in night mode.

Use the two memories to store settings corresponding to different shooting conditions.

## Automatic adjustment (AWB: AWB A or AWB B)

### When performing operations from a wireless remote control

1. Shoot a white subject (such as a white wall or handkerchief) so that it fills the screen.
  - Do not shoot shiny or very bright objects.
- Steps 2 through 8 represent the procedure for selecting the [AWB A] or [AWB B] memory. They need not be taken if a selection has already been made.
2. Select [Scene1], [Scene2], [Scene3] or [Scene4] as the shooting mode by following the procedure in "Selecting the shooting modes (scene files)" (→ page 31).

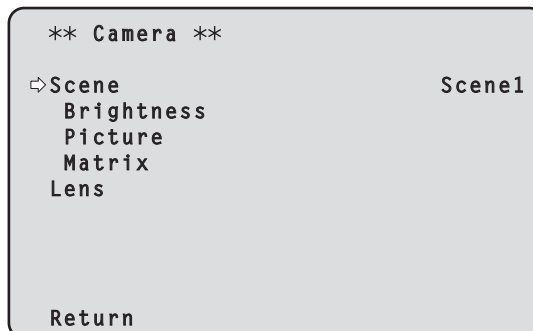

3. Press the <▲> or <▼> button to bring the cursor to [Picture].

4. Press the <○> button.

The [Picture 1/8] screen is displayed.

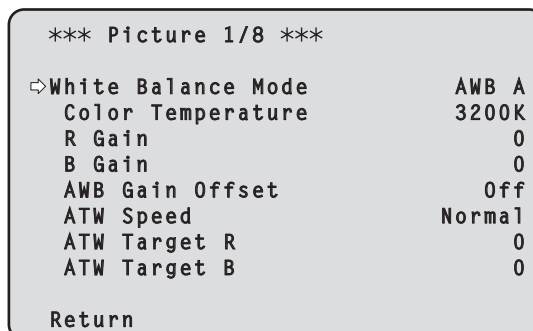

5. Press the <▲> or <▼> button to bring the cursor to [White Balance Mode].

6. Press the <○> button.

[White Balance Mode] starts blinking.

7. Press the <▲> or <▼> button to change the White Balance Mode to be used to [AWB A] or [AWB B], and press the <○> button to enter the selection.

8. Press and hold the <MENU> button for about 2 seconds.

The camera menu display is exited.

## White balance adjustment (continued)

### 9. Press the <SET> button for about 2 seconds.

The auto white balance adjustment (AWB) and auto black balance adjustment (ABB) are performed, and the white balance setting is entered.

- When [On] has been selected as the [OSD Status] (→ page 59) setting, the “AWB OK” message will appear at the center of the screen when the white balance adjustment is completed successfully.

When the black balance adjustment is completed successfully, the “ABB OK” message appears at the center of the screen.



#### <NOTE>

- The black balance is set at the same time.  
When this takes place, the lens is closed and then the adjustment is performed so the screen will temporarily turn black.  
When only the auto white balance adjustment (AWB) is to be performed, ensure that the <SET> button is pressed or held down for a period of time which does not exceed 2 seconds.
- Adjustment cannot be performed while the color bar is displayed.  
Switch to the camera image by pressing the <MODE> button.
- When the adjustment has failed, an error message such as “OUT RANGE NG”, “HIGH LIGHT NG”, “LOW LIGHT NG” or “ATW NG” is displayed.

## When performing operations from a controller

### When using an AW-RP150

Refer to the operating instructions for the controller.

#### <NOTE>

- White balance may not be correctly set if the lighting of the object is too weak.
- Since the unit has a built-in memory, the set white balance will remain in the memory even if power is turned off. Therefore, it is not necessary to reset the white balance if the color temperature of those objects remains unchanged. However, it must be reset if the color temperature changes, such as when you move from indoors to outside, or vice versa.

## Auto tracking white adjustment (ATW)

When the white balance adjustment is set to [ATW], the white balance continues to be adjusted automatically all the time, and it is automatically corrected even when the light source or color temperature has changed to produce completely natural pictures.

This function works when [ATW] is selected instead of [AWB A] or [AWB B] by following the steps for “Automatic adjustment” in “White balance adjustment” (→ page 36).

#### <NOTE>

- ATW might not function properly when high brightness light (ex. fluorescent lamp) beams into a screen.
- White balance may not be accurately set if there is no white object in the scene being shot.
- The white balance may shift out of adjustment when different kinds of light sources such as sunlight and fluorescent lighting are applied.

## 3200K and 5600K presets

When [3200K] or [5600K] is selected for the white balance, the white balance is set using a color temperature of 3200 K (equivalent to halogen light) or 5600 K (equivalent to daylight), respectively.  
This function works when [3200K] or [5600K] is selected instead of [AWB A] or [AWB B] by following the steps for “Automatic adjustment” in “White balance adjustment” (→ page 36).

## VAR

When [VAR] is selected for the white balance, you can select a color temperature between 2000K and 15000K.

#### <NOTE>

- The displayed [VAR] value does not guarantee an absolute value. Use the value as a reference.

## Black balance adjustment

---

Adjust the zero levels of the three primary colors (RGB) to reproduce black accurately. If the black balance is out of adjustment, not only will black be reproduced poorly, but the color tones of the screen as a whole will also be degraded.

Readjustment of the black balance is not required under normal circumstances but is necessary in the following situations.

- **Perform adjustment when using the unit for the first time or when the unit has not been used for a prolonged period.**
- **Perform adjustment when the ambient temperature changes significantly, such as during changes of the season.**

### Automatic adjustment

#### When performing operations from a wireless remote control

---

The procedure is identical to that of "Automatic adjustment" (→ page 36) in "White balance adjustment".

The black balance can be configured by performing automatic white balance adjustment (AWB) and automatic black balance adjustment (ABB).

- The white balance will also be configured, so be sure to prepare the conditions for white balance adjustment before performing the procedure.
- Adjustment cannot be performed while the color bar is displayed. Switch to the camera image by pressing the <MODE> button.

#### When performing operations from a controller

---

##### When using an AW-RP150

Refer to the operating instructions for the controller.

## Black level (master pedestal) adjustment

The black level can be adjusted when using a multiple number of cameras including the unit. Ask your dealer to perform this adjustment. (Use an oscilloscope or waveform monitor for the adjustment.) Adjust the black level in accordance with the units and devices used.

### When performing operations from a wireless remote control

**1. Press the <M/IRIS> button.**

Set the iris to the manual mode.

**2. Press the <IRIS →> button.**

The lens iris is stopped down.

**3. Press the <▲> or <▼> button to bring the cursor to [Picture].**

**4. Press the <○> button.**

The [Picture 2/8] screen is displayed.

```
*** Picture 2/8 ***
◁ Chroma Level           0%
  Chroma Phase           0
  Master Pedestal        0
  R Pedestal             0
  G Pedestal             0
  B Pedestal             0
  Pedestal Offset       Off

Return
```

**5. Press the <▲> or <▼> button to bring the cursor to [Master Pedestal].**

```
*** Picture 2/8 ***
  Chroma Level           0%
  Chroma Phase           0
◁ Master Pedestal        0
  R Pedestal             0
  G Pedestal             0
  B Pedestal             0
  Pedestal Offset       Off

Return
```

**6. Press the <○> button to start the [Master Pedestal] value blinking.**

**7. Press the <▲> or <▼> button, change the [Master Pedestal] value, and press the <○> button to enter the selection.**

Adjust the value so that it matches the black level.

The pedestal values can be adjusted finely using the [R Pedestal], [G Pedestal] and [B Pedestal] settings. (→ page 46, page 99)

**8. Press and hold the <MENU> button for about 2 seconds.**

The camera menu display is exited.

**9. If necessary, press the <A/IRIS> button to adjust the iris automatically.**

### When performing operations from a controller

**When using an AW-RP150**

Refer to the operating instructions for the controller.

# Genlock adjustment

The genlock adjustment is performed to achieve phase alignment by applying external synchronization (genlock) when a multiple number of cameras will be used or when the unit will be used in combination with other devices.

This unit supports BBS (Black Burst Sync) and tri-level sync external synchronization signals.

Ask your dealer to perform this adjustment.

(Use a dual-trace oscilloscope for the adjustment.)

## Horizontal phase adjustment

Observe the waveforms of the external sync signal input (tri-level sync signal) and video signal output on the dual-trace oscilloscope, and use the wireless remote control or controller to bring the horizontal phase into alignment.

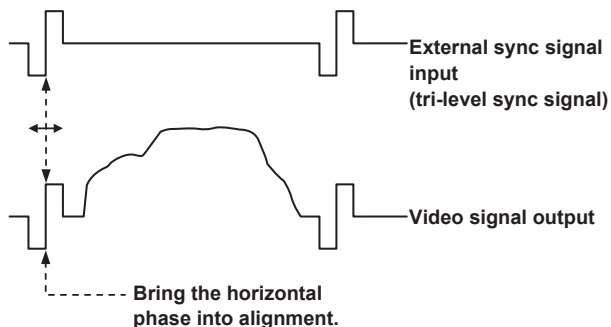

Example: When the tri-level sync phase is adjusted

## When performing operations from a wireless remote control

1. Follow the operation steps in “Basic setup operations” (→ page 41) to display the Top Menu.

2. Press the <▲> or <▼> button to bring the cursor to [System].

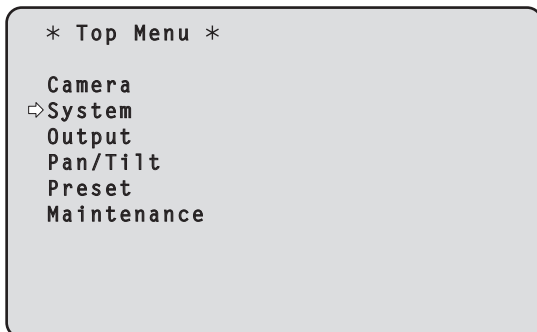

3. Press the <○> button.

The [System] screen appears.

4. Press the <▲> or <▼> button to bring the cursor to [Genlock], and press the <○> button.

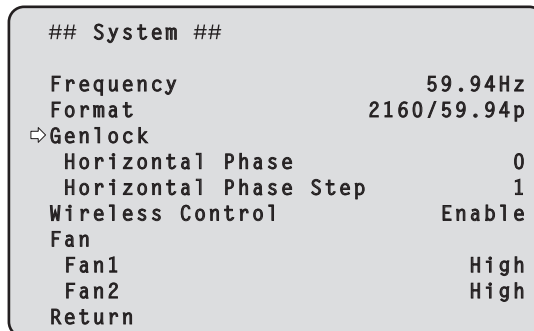

5. Press the <▲> or <▼> button to bring the cursor to [Horizontal Phase], and press the <○> button.

The [Horizontal Phase] value starts blinking.

6. Press the <▲> or <▼> button to change the [Horizontal Phase] value, adjust the value so that the horizontal phase is brought into alignment, and press the <○> button.

The extent of the phase adjustment can be selected using [Horizontal Phase Step].

7. Press and hold the <MENU> button for about 2 seconds.

The camera menu display is exited.



# Basic setup operations

Camera menus are displayed on the monitor when the unit's settings are to be selected.

The monitor is connected to the video signal output connector.

The basic camera menu operations involve displaying sub-menus from the Top Menu items, and selecting settings on the sub-menus.

Some sub-menus have menu items for performing more detailed settings.

The camera menu operations are conducted using the wireless remote control.

Described below are the Basic setup operations for changing the camera menu item settings using the wireless remote control.

## ■ Wireless remote control operations

Camera menu operation	Wireless remote control
<b>Selecting a camera to operate</b>	Press the <CAM1>, <CAM2>, <CAM3>, or <CAM4> button.
<b>Displaying the Top Menu</b>	Press and hold the <MENU> button for about 2 seconds.
<b>Selecting items</b>	Press the <▲>, <▼>, <◀>, or <▶> button.
<b>Displaying sub-menus</b>	Press the <○> button.
<b>Returning to the previous menu</b>	Place the cursor on [Return], and press the <○> button.
<b>Changing settings</b>	Place the cursor on the item you want to change, and press the <○> button to make the setting value blink. Change the value using the <▲>, <▼>, <◀>, or <▶> button, and press the <○> button to confirm.
<b>Canceling setting changes</b>	Press the <MENU> button (hold for less than 2 seconds) while the setting value is blinking.
<b>Exiting camera menu operations</b>	Press and hold the <MENU> button for about 2 seconds.

### <NOTE>

- When AW-RP150 is connected, refer to the operating instructions for the controller.

## When performing the operations using the wireless remote control

**1. Press the <CAM1>, <CAM2>, <CAM3> or <CAM4> button to select the unit which is to be operated.**

**2. Press and hold the <MENU> button for about 2 seconds.**  
The Top Menu is displayed.

**3. Press the <▲> or <▼> button to bring the cursor to the item to be selected.**

Each time the <▲> or <▼> button is pressed, the cursor moves.

The cursor can be moved in the same way using the <◀> or <▶> buttons.

**4. Press the <○> button.**

The sub-menu of the selected item is displayed.

(Some sub-menu items have a sub-menu of their own.)

**5. Press the <▲> or <▼> button to bring the cursor to the item to be set.**

Each time the <▲> or <▼> button is pressed, the cursor moves.

The cursor can be moved in the same way using the <◀> or <▶> button.

With the cursor at the [Return] position, press the <○> button to return to the previous menu.

**6. Press the <○> button.**

The value of the item to be set starts blinking.

**7. Press the <▲> or <▼> button to change the setting.**

The setting can be changed in the same way using the <◀> or <▶> button.

**8. Press the <○> button.**

The value of the item to be set is entered, and it stops blinking.

**9. After the setting has been completed, press the <MENU> button for about 2 seconds.**

The camera menu display is exited.

# Camera menu items

## Setting the camera menu items

Camera menus are displayed on the monitor when the unit's settings are to be selected.

The monitor is connected to the MONITOR OUT connector <MONI OUT>.

The basic camera menu operations involve displaying sub-menus from the Top Menu items, and selecting settings on the sub-menus.

Some sub-menus have menu items for performing more detailed settings.

For details on the "Basic setup operations" to display the camera menus and change the items using the controller (AW-RP150), refer to page 41.

The "\*" and "#" marks in the menu titles indicate the hierarchical level of the menu currently displayed.

For instance, "\* Top Menu \*" indicates the first hierarchical level whereas "\*\* Camera \*\*" and "## System ##" indicate that the second hierarchical level is now displayed.

Menu items accompanied by a "\*" mark indicate data which is stored on a scene by scene basis; menu items accompanied by a "#" mark indicate data which is stored together for one camera regardless of the scenes.

For details on factory default settings, see "Camera menu item table" (→ page 66).

## Top Menu screen

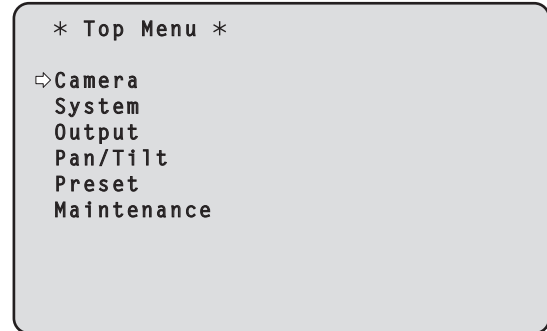

### Camera

Select this to open the camera menu relating to the camera images.

### System

Select this to display the System menu used to set up system format of the camera or adjust the genlock (external synchronization) phase or establish the camera output image settings.

### Output

Select this to display the Output menu used for setting video/audio output for the camera, OSD output, etc.

### Pan/Tilt

Select this to display the Pan/Tilt menu used for various pan/tilt operations.

### Preset

Select this to display the Preset menu used for various preset playback operations.

### Maintenance

Select this to display the Maintenance menu used to check the camera's firmware version or initialize its settings.

### <NOTE>

- The Top Menu does not have a [Return].  
To close the menu screen, use the controller to perform the operation to close the menu screen. For further details, refer to "Basic setup operations" (→ page 41).

## Camera menu items (continued)

### Camera screen

This menu is used for the camera image settings.

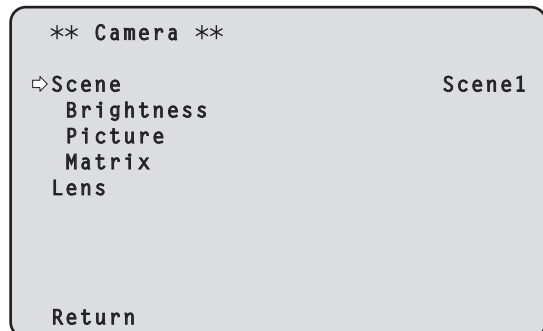

#### Scene [Scene1, Scene2, Scene3, Scene4]

Selected here is the shooting mode that matches the shooting situation.

Select the mode which best suits the prevailing shooting conditions and the user's preferences.

##### Scene1, Scene2, Scene3, Scene4:

In these modes, the detailed settings and adjustments are established manually to match the prevailing shooting conditions and the user's preferences.

#### Brightness

This menu item displays the Brightness screen on which to set the brightness of the images.

#### Picture

This menu item displays the Picture screen on which to adjust the picture quality.

#### Matrix

This menu item displays the Matrix screen on which to set the color matrix.

#### Lens

This menu item displays the Lens screen for making lens settings.

#### Return

Return to the previous menu level.

### Brightness 1/2 screen

This menu item is selected to set the brightness of the pictures.

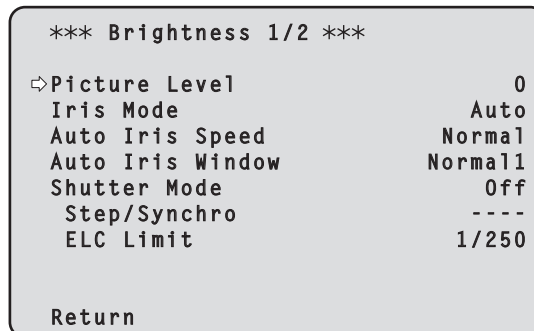

#### Picture Level [-50 to +50]

This menu item is selected to set the target picture level for automatic exposure compensation.

Its setting takes effect when [Auto] or [ELC] has been selected as the setting for any of the following automatic exposure compensation functions.

- When [Iris Mode] is set to [Auto]
- When [Shutter Mode] is set to [ELC]
- When [Gain] is set to [Auto]

#### Iris Mode [Manual, Auto]

This menu item is used to select whether the iris is to be adjusted automatically or manually.

Manual	The iris is adjusted manually.
Auto	Auto exposure compensation is performed so that the target level which was set using [Picture Level] is reached.

#### Auto Iris Speed [Slow, Normal, Fast]

Set the control speed of the auto iris function.

Slow	Control the iris at a slow speed.
Normal	Control the iris at a normal speed.
Fast	Control the iris at a fast speed.

#### Auto Iris Window [Normal1, Normal2, Center]

Select the detection window for the auto iris.

Normal1	Window towards the center of the screen.
Normal2	Window towards the bottom of the screen.
Center	Spotted window in the center of the screen.

## Camera menu items (continued)

### Shutter Mode [Off, Step, Synchro, ELC]

Select for camera shutter mode.

Off	The shutter is set to OFF.
Step	The step shutter is set (the steps can be changed).
Synchro	The synchro shutter is set (the setting can be changed continuously).
ELC	The electronic shutter is controlled and the light quantity is adjusted automatically.

#### Step/Synchro

This is used to adjust the shutter speed in the mode which was selected as the [Shutter Mode] setting.

When a higher shutter speed is selected, fast-moving subjects do not become blurred easily but the images will be darker.

The shutter speeds that can be set are listed below.

	When [Step] is selected as the [Shutter Mode]	When [Synchro] is selected as the [Shutter Mode]
59.94p/59.94i mode	1/60, 1/100, 1/120, 1/250, 1/500, 1/1000, 1/2000, 1/4000, 1/8000, 1/10000	60.0 Hz to 7200 Hz
29.97p mode	1/30, 1/60, 1/100, 1/120, 1/250, 1/500, 1/1000, 1/2000, 1/4000, 1/8000, 1/10000	30.0 Hz to 7200 Hz
23.98p/24p mode	1/24, 1/48, 1/60, 1/100, 1/120, 1/250, 1/500, 1/1000, 1/2000, 1/4000, 1/8000, 1/10000	24.0 Hz to 7200 Hz
50p/50i mode	1/60, 1/100, 1/120, 1/250, 1/500, 1/1000, 1/2000, 1/4000, 1/8000, 1/10000	50.0 Hz to 7200 Hz
25p mode	1/25, 1/50, 1/60, 1/100, 1/120, 1/250, 1/500, 1/1000, 1/2000, 1/4000, 1/8000, 1/10000	25.0 Hz to 7200 Hz

#### <NOTE>

- When [Shutter Mode] is set to [Off] in 29.97p, 23.98p, or 25p mode, the shutter speed is set to [1/50].

#### ELC Limit [1/100, 1/120, 1/250]

Set the maximum shutter level when ELC is operating.

#### Return

Return to the previous menu level.

### Brightness 2/2 screen

*** Brightness 2/2 ***	
◁ Gain	0dB
Super Gain	Off
AGC Max Gain	18dB
Frame Mix	Off
ND Filter	Through
Day/Night	Day
Return	

#### Gain [When Super Gain is Off: Auto, 0dB to 36dB, When Super Gain is On: Auto, 0dB to 42dB]

The image gain is adjusted here.

In locations which are too dark, adjust the gain upward; conversely, in locations which are too bright, adjust it downward.

When [Auto] is set, the light quantity is adjusted automatically.

The noise increases when the gain is increased.

#### <NOTE>

- [Gain] cannot be set to [Auto] when [Frame Mix] is set to [18dB] or [24dB].

#### Super Gain [Off, On]

Set the super gain (increased sensitivity) mode.

Off	Do not set super gain mode.
On	Set super gain mode.

#### AGC Max Gain [6dB, 12dB, 18dB]

When [Auto] is selected as the [Gain] setting, the maximum gain-up amount can be set.

#### Frame Mix [Off, 6dB, 12dB, 18dB, 24dB]

Select for frame addition (gain-up using sensor storage) amount.

When frame addition is performed, it will appear as if the images are missing some frames.

This cannot be configured when the format is 2160/29.97p, 2160/23.98p, 2160/24p, 2160/25p, 1080/29.97p, 1080/23.98p(59.94i), 1080/29.97PsF, 1080/23.98PsF, 1080/25p or 1080/25PsF.

[Frame Mix] cannot be set to [18dB] or [24dB] when [Iris Mode], [Gain], or [Focus Mode] is set to [Auto]. (When setting [Frame Mix] to [18dB] or [24dB], set [Iris Mode] and [Focus Mode] to [Manual] and set [Gain] to any setting other than [Auto].)

#### <NOTE>

- Under discharge tube illumination, such as fluorescent and mercury-vapor lights, the brightness may change synchronously, colors may change, and horizontal stripes may flow up and down the image. In such cases, we recommend setting the electronic shutter speed to 1/100 in regions with 50 Hz power supply frequency, and to OFF in regions with 60 Hz power supply frequency.

## Camera menu items (continued)

### ND Filter [Through, 1/4, 1/16, 1/64]

Set the transmittance of the lens' built-in ND (neutral density) filter. The filter switches when the setting is fixed.

Through	Do not set ND filter.
1/4	Set ND filter transmittance to 1/4.
1/16	Set ND filter transmittance to 1/16.
1/64	Set ND filter transmittance to 1/64.

### Day/Night [Day, Night]

Switch between standard shooting and night-vision shooting (shooting with infrared light).

Day	Standard shooting (day mode)
Night	Night-vision shooting (night mode)

#### <NOTE>

- In night mode, video output will be in black and white. In addition, the iris will be forcibly opened.
- White balance adjustment is not possible in night mode.
- ND filter switching is not possible in night mode.
- [Pedestal] adjustment is not possible in night mode.

### Return

Return to the previous menu level.

## Picture 1/8 screen

*** Picture 1/8 ***	
◁ White Balance Mode	AWB A
Color Temperature	3200K
R Gain	0
B Gain	0
AWB Gain Offset	Off
ATW Speed	Normal
ATW Target R	0
ATW Target B	0
Return	

### White Balance Mode

#### [ATW, AWB A, AWB B, 3200K, 5600K, VAR]

Set the white balance mode.

Select the mode when the coloring is not natural because of the nature of the light source or other factors.

If the white color serving as the reference can be recognized, subjects can be shot with natural coloring.

ATW	In this mode, the white balance is compensated for automatically, even if changes occur in the light source or color temperature, by a process of continuous and automatic adjustment.
AWB A AWB B	When [AWB A] or [AWB B] is selected and the white balance is executed, the adjustment results obtained are stored in the memory selected. When [AWB A] or [AWB B] is then selected, the white balance stored in the selected memory can be recalled.
3200K	This is the white balance mode which is ideal when a 3200K halogen light is used as the light source.
5600K	This is the white balance mode which is ideal when 5600K sunlight or fluorescent lighting is used as the light source.
VAR	You can specify a color temperature between 2000K to 15000K.

### Color Temperature [2000K to 15000K]

You can specify a color temperature between 2000K to 15000K. Its setting takes effect when [VAR] has been selected as the [White Balance Mode] setting.

### R Gain [-200 to +200]

This enables the R gain to be adjusted.

Its setting takes effect when [AWB A], [AWB B] or [VAR] has been selected as the [White Balance Mode] setting.

### B Gain [-200 to +200]

This enables the B gain to be adjusted.

Its setting takes effect when [AWB A], [AWB B] or [VAR] has been selected as the [White Balance Mode] setting.

### AWB Gain Offset [Off, On]

When auto white balance is performed by setting [White Balance Mode] to [AWB A] or [AWB B], set the values for Rch gain and Bch gain.

Off	Set the value of [R Gain] and [B Gain] to [0].
On	Maintain the value set in [R Gain] and [B Gain].

## Camera menu items (continued)

### ATW Speed [Normal, Slow, Fast]

Set the control speed of the ATW function.

Normal	Tracks at normal speed.
Slow	Tracks at a speed slower than [Normal].
Fast	Tracks at a speed faster than [Normal].

This is only enabled when [White Balance Mode] is set to [ATW].

### ATW Target R [-10 to +10]

Make fine adjustments to the Rch output when converging with the auto tracking white balance operation.

### ATW Target B [-10 to +10]

Make fine adjustments to the Bch output when converging with the auto tracking white balance operation.

### Return

Return to the previous menu level.

## Picture 2/8 screen

*** Picture 2/8 ***	
◁ Chroma Level	0%
Chroma Phase	0
Master Pedestal	0
R Pedestal	0
G Pedestal	0
B Pedestal	0
Pedestal Offset	Off
Return	

### Chroma Level [Off, -99% to 99%]

Set here the color intensity (chroma level) of the images.

### Chroma Phase [-31 to +31]

Make fine adjustments to the hue of the colors in the images.

### Master Pedestal [-200 to +200]

This item is used to adjust the black level (adjust the pedestal). These parts become darker when a negative setting is selected and, conversely, lighter when a positive setting is selected.

#### R Pedestal [-100 to +100]

This enables the R pedestal to be adjusted.

#### G Pedestal [-100 to +100]

This enables the G pedestal to be adjusted.

#### B Pedestal [-100 to +100]

This enables the B pedestal to be adjusted.

### Pedestal Offset [Off, On]

Set the pedestal level of the Rch, Gch, and Bch when the auto black balance has been adjusted.

Off	Set the pedestal level to [0] for [R Pedestal], [G Pedestal], and [B Pedestal].
On	Maintain the values set for each of [R Pedestal], [G Pedestal], and [B Pedestal].

### Return

Return to the previous menu level.

Picture 3/8 screen

*** Picture 3/8 ***	
⇨ Detail	On
Master Detail	0
Detail Coring	0
V Detail Level	0
Detail Frequency	0
Level Depend.	0
Knee Aperture Level	1
Detail Gain(+)	0
Detail Gain(-)	0
Return	

Picture 4/8 screen

*** Picture 4/8 ***	
⇨ Skin Detail	Off
Skin Detail Effect	16
Return	

**Detail [Off, On]**

Turn on/off the contour (sharpness of images) adjustment of images.

**Master Detail [-31 to +31]**

Adjust the contour correction level (master).  
This is only enabled when [Detail] is set to [On].

**Detail Coring [0 to 60]**

Set the level of the signal (including noise) which makes the detail effect not work.  
This is only enabled when [Detail] is set to [On].

**V Detail Level [-7 to +7]**

Adjust the contour correction level in the vertical direction.  
This is only enabled when [Detail] is set to [On].

**Detail Frequency [-7 to +7]**

Set the boost frequency of detail.

- 7: Low frequency
- to
- +7: High frequency

When a high frequency is selected, the detail effect is added to subjects with more definition.  
This is only enabled when [Detail] is set to [On].

**Level Depend. [-7 to +7]**

When the detail of bright signals are emphasized, the detail of dark parts are compressed.  
The larger the [Level Depend.] setting, the more detail of bright parts is compressed.  
This is only enabled when [Detail] is set to [On].

**Knee Aperture Level [0 to 5]**

Set the detail level of very bright parts.  
This is only enabled when [Detail] is set to [On].

**Detail Gain(+) [-31 to +31]**

Set the detail level of the plus direction (direction to be made brighter).  
This is only enabled when [Detail] is set to [On].

**Detail Gain(-) [-31 to +31]**

Set the detail level of the minus direction (direction to be made darker).  
This is only enabled when [Detail] is set to [On].

**Return**

Return to the previous menu level.

**Skin Detail [Off, On]**

This function smooths skin and produces a more beautiful image.  
This is only enabled when [Detail] is set to [On].

**Skin Detail Effect [0 to 31]**

The skin of human subjects appears smoother the larger the setting value.  
This is only enabled when [Detail] is set to [On] and [Skin Detail] is set to [On].

**Return**

Return to the previous menu level.

Picture 5/8 screen

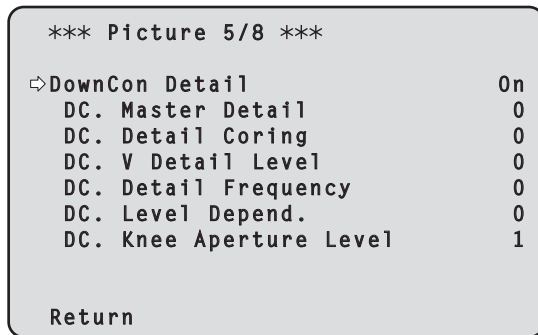

**DownCon Detail [Off, On]**

Turn on/off the contour (sharpness of images) adjustment of images down-converted from 4K to HD.

This is enabled when [Format] is the following.

- 2160/59.94p, 2160/29.97p, 2160/23.98p, 2160/24p, 2160/50p, 2160/25p

**DC. Master Detail [-31 to +31]**

Adjust the contour correction level (master) for images down-converted from 4K to HD.

This is enabled when [Format] is the following.

- 2160/59.94p, 2160/29.97p, 2160/23.98p, 2160/24p, 2160/50p, 2160/25p

This is only enabled when [DownCon Detail] is set to [On].

**DC. Detail Coring [0 to 60]**

Set the level of the signal (including noise) which makes the detail effect not work for images down-converted from 4K to HD.

This is enabled when [Format] is the following.

- 2160/59.94p, 2160/29.97p, 2160/23.98p, 2160/24p, 2160/50p, 2160/25p

This is only enabled when [DownCon Detail] is set to [On].

**DC. V Detail Level [-7 to +7]**

Adjust the contour correction level in the vertical direction for images down-converted from 4K to HD.

This is enabled when [Format] is the following.

- 2160/59.94p, 2160/29.97p, 2160/23.98p, 2160/24p, 2160/50p, 2160/25p

This is only enabled when [DownCon Detail] is set to [On].

**DC. Detail Frequency [-2 to +2]**

Set the boost frequency of detail for images down-converted from 4K to HD.

-2: Low frequency  
to

+2: High frequency

When a high frequency is selected, the detail effect is added to subjects with more definition.

This is enabled when [Format] is the following.

- 2160/59.94p, 2160/29.97p, 2160/23.98p, 2160/24p, 2160/50p, 2160/25p

This is only enabled when [DownCon Detail] is set to [On].

**DC. Level Depend. [-7 to +7]**

The larger the setting for images down-converted from 4K to HD, the more detail of bright parts is compressed.

This is enabled when [Format] is the following.

- 2160/59.94p, 2160/29.97p, 2160/23.98p, 2160/24p, 2160/50p, 2160/25p

This is only enabled when [DownCon Detail] is set to [On].

**DC. Knee Aperture Level [0 to 5]**

Set the detail level of very bright parts in images down-converted from 4K to HD.

This is enabled when [Format] is the following.

- 2160/59.94p, 2160/29.97p, 2160/23.98p, 2160/24p, 2160/50p, 2160/25p

This is only enabled when [DownCon Detail] is set to [On].

**Return**

Return to the previous menu level.



Picture 6/8 screen

*** Picture 6/8 ***	
⇨ Gamma Mode	HD
Gamma	0.45
F-REC Dynamic Level	500%
F-REC Black STR. Level	0%
V-REC Knee Slope	150%
V-REC Knee Point	30%
Black Gamma	0
Black Gamma Range	1
DRS	Off
Return	

**Black Gamma Range [1 to 3]**

Set the maximum level of compression/expansion.

1	Around 20%
2	Around 30%
3	Around 40%

**DRS [Off, Low, Mid, High]**

Set the DRS function which performs correction when video with high light/dark contrast is displayed.

You can select from a [Low], [Mid], or [High] effect level.

This is only enabled when [Gamma Mode] is set to other than [HLG].

**Return**

Return to the previous menu level.

**Gamma Mode**

[HD, FILMLIKE1, FILMLIKE2, FILMLIKE3, FILM REC, VIDEO REC, HLG]

Select the type of gamma curve.

HD	HD (High Definition) video gamma characteristic.
FILMLIKE1	Characteristic capable of reproducing better gradation in highlights than HD gamma.
FILMLIKE2	Characteristic capable of reproducing better gradation in highlights than [FILMLIKE1].
FILMLIKE3	Characteristic capable of reproducing better gradation in highlights than [FILMLIKE2].
FILM REC	Cinema film gamma characteristic.
VIDEO REC	Cinema video gamma characteristic.
HLG	Hybrid Log Gamma characteristic.

**Gamma [0.30 to 0.75]**

Adjust the gamma correction level.

Specifying smaller values results in a gentler gamma curve for the slope of low-brightness areas and sharper contrast.

Specifying larger values results in an expanded gradient for dark areas and produces brighter images. The gamma curve for low-brightness areas will be steeper, and contrast will be softer.

This is only enabled when [Gamma Mode] is set to other than [HLG].

**F-REC Dynamic Level [200%, 300%, 400%, 500%, 600%]**

When [FILM-REC] is selected in [GAMMA MODE SEL], you can set the dynamic range.

This is only enabled when [Gamma Mode] is set to [FILM REC].

**F-REC Black STR. Level [0% to 30%]**

When [FILM-REC] is selected in [GAMMA MODE SEL], you can set the black stretch.

This is only enabled when [Gamma Mode] is set to [FILM REC].

**V-REC Knee Slope [150%, 200%, 250%, 300%, 350%, 400%, 450%, 500%]**

When [VIDEO-REC] is selected in [GAMMA MODE SEL], you can set the knee slope.

This is only enabled when [Gamma Mode] is set to [VIDEO REC].

**V-REC Knee Point [30% to 107%]**

When [VIDEO-REC] is selected in [GAMMA MODE SEL], you can set the knee point.

This is only enabled when [Gamma Mode] is set to [VIDEO REC].

**Black Gamma [-8 to +8]**

Set the gamma curve for dark areas.

-8 to -1	Compresses dark parts.
1 to 8	Expands dark parts.

Picture 7/8 screen

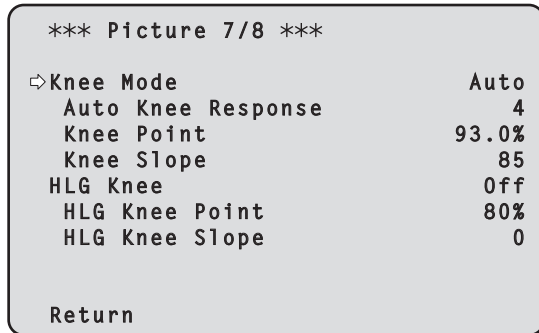

Picture 8/8 screen

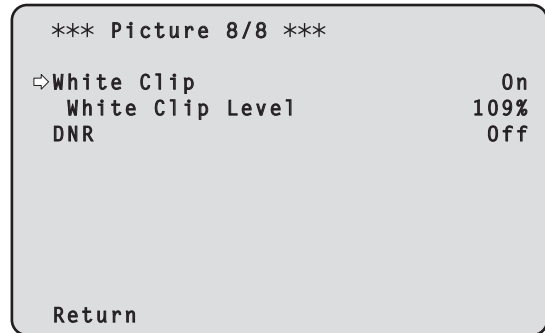

**Knee Mode [Off, Auto, Manual]**

Set the operating mode for gradation compression (knee).

Off	Turn the knee function off.
Auto	Enable the knee function, and set the knee point and knee slope automatically.
Manual	Enable the knee function, and set the knee point and knee slope manually.

This is only enabled when [Gamma Mode] is set to other than [HLG].

**Auto Knee Response [1 to 8]**

Set the speed of the auto knee response.

The response speed increases the lower the setting value.

This is only enabled when [Gamma Mode] is set to other than [HLG].

**Knee Point [70.0% to 107.0%]**

Set the compression level (knee point) position for high-brightness video signals.

This is only enabled when [Gamma Mode] is set to other than [HLG].

This is only enabled when [Knee Mode] is set to [Manual].

**Knee Slope [0 to 99]**

Set the knee slope.

This is only enabled when [Gamma Mode] is set to other than [HLG].

This is only enabled when [Knee Mode] is set to [Manual].

**<NOTE>**

- When [DRS] is enabled, the knee setting is disabled.

**HLG Knee [Off, On]**

Enable or disable the operation of the HLG knee.

This is only enabled when [Gamma Mode] is set to [HLG].

**HLG Knee Point [55% to 109%]**

Set the position of the HLG knee point.

This is only enabled when [Gamma Mode] is set to [HLG].

**HLG Knee Slope [0 to 100]**

Set the slope of the HLG knee.

This is only enabled when [Gamma Mode] is set to [HLG].

**Return**

Return to the previous menu level.

**White Clip [Off, On]**

Turn the white clip function off/on.

This is only enabled when [Gamma Mode] is set to other than [HLG].

**White Clip Level [90% to 109%]**

Set the white clip level.

This is only enabled when [Gamma Mode] is set to other than [HLG].

This is only enabled when [White Clip] is set to [On].

**<NOTE>**

- When [Knee Mode] is set to [Auto] and the value of [White Clip Level] is changed, the knee value will also change.

**DNR [Off, Low, High]**

Set the digital noise reduction level for outputting bright, clear images without noise, even at night and low-light conditions.

When [Low] or [High] is selected, noise can be eliminated.

However, image lag may increase.

**Return**

Return to the previous menu level.

**Matrix 1/5 screen**

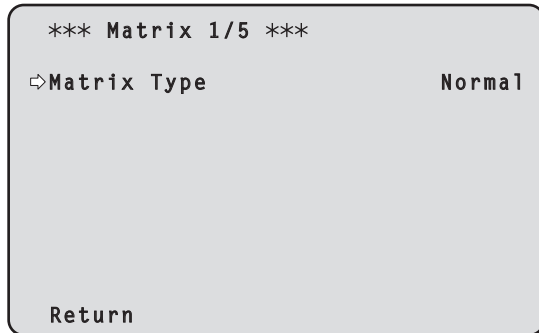

**Matrix 2/5 screen**

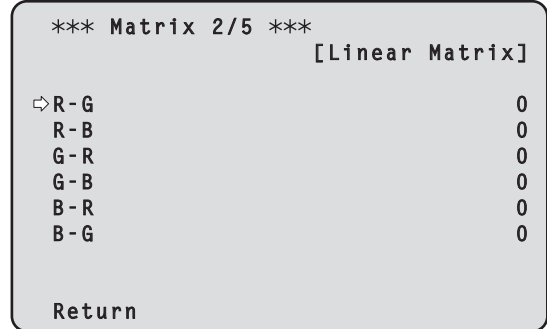

**Matrix Type [Normal, EBU, NTSC, User]**

Select the type of color matrix.

Normal	This item is used to load the preset color matrix data and compensate for the saturation and color phase.
EBU	
NTSC	
User	On the [Matrix 2/5] screen, the [Linear Matrix] value can be adjusted by the user. On the [Matrix 3/5] screen, [Matrix 4/5] screen or [Matrix 5/5] screen, the [Color Correction] value can be adjusted by the user.

**Linear Matrix**

This can be set when [User] has been selected as the [Matrix Type] setting.

R-G	Adjust the color to between -63 and +63 for each axis direction.
R-B	
G-R	
G-B	
B-R	
B-G	

**Return**

Return to the previous menu level.

**Return**

Return to the previous menu level.

**Matrix 3/5 screen**

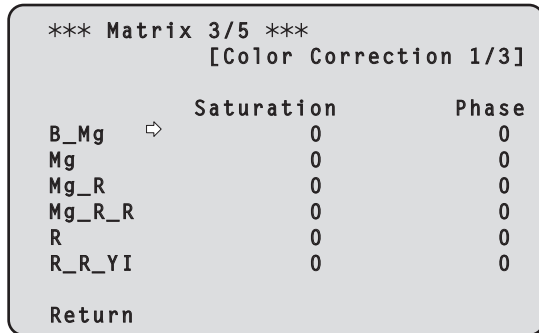

**Color Correction 1/3**

This can be set when [User] has been selected as the [Matrix Type] setting.

Adjust the saturation and hue.

**Saturation [-63 to +63]**

Adjust the saturation for each color.

**Phase [-63 to +63]**

Adjust the hue for each color.

B_Mg	Color between blue and magenta
Mg	Magenta
Mg_R	Color between magenta and red
Mg_R_R	Color with a 1:3 magenta to red ratio
R	Red
R_R_YI	Color with a 3:1 red to yellow ratio

**Return**

Return to the previous menu level.

**Matrix 4/5 screen**

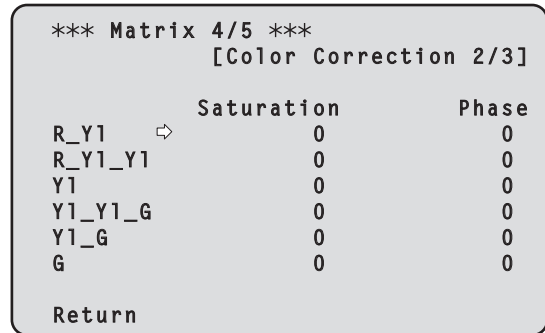

**Color Correction 2/3**

This can be set when [User] has been selected as the [Matrix Type] setting.

Adjust the saturation and hue.

**Saturation [-63 to +63]**

Adjust the saturation for each color.

**Phase [-63 to +63]**

Adjust the hue for each color.

R_YI	Color between red and yellow
R_YI_YI	Color with a 1:3 red to yellow ratio
YI	Yellow
YI_YI_G	Color with a 3:1 yellow to green ratio
YI_G	Color between yellow and green
G	Green

**Return**

Return to the previous menu level.

**Matrix 5/5 screen**

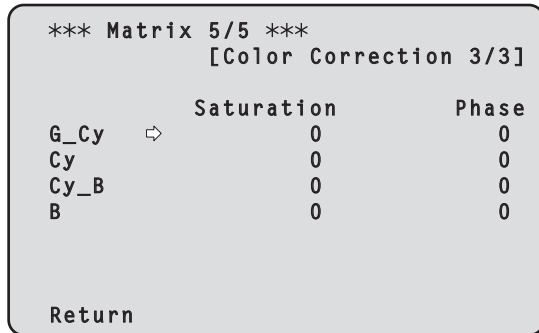

**Color Correction 3/3**

This can be set when [User] has been selected as the [Matrix Type] setting.

Adjust the saturation and hue.

**Saturation [-63 to +63]**

Adjust the saturation for each color.

**Phase [-63 to +63]**

Adjust the hue for each color.

G_Cy	Color between green and cyan
Cy	Cyan
Cy_B	Color between cyan and blue
B	Blue

**Return**

Return to the previous menu level.

**Lens screen**

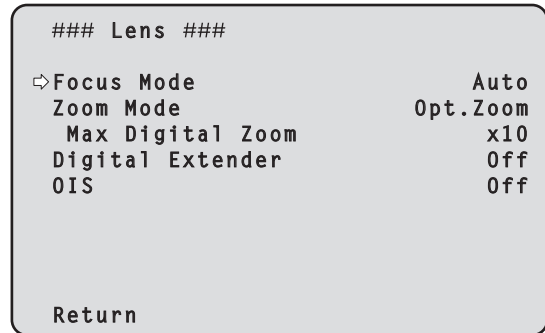

**Focus Mode [Auto, Manual]**

Select auto or manual mode for the focus adjustment function.

Auto	Always adjust focus automatically.
Manual	Adjust focus manually.

**Zoom Mode [Opt.Zoom, i.Zoom, D.Zoom]**

Set the maximum magnification rate for zoom.

Opt.Zoom	Use only optical zoom. Optical zoom up to 20x is possible.
i.Zoom	Enable the i.Zoom function. When this function is enabled, digital zoom is used while reducing image degradation. Up to 26x zoom is possible combining optical zoom and digital zoom.
D.Zoom	Enable the digital zoom function. Higher digital zoom magnifications will result in coarser images.

**Max Digital Zoom**

**[x2, x3, x4, x5, x6, x7, x8, x9, x10]**

Set the maximum digital zoom magnification.

This is only enabled when [Zoom Mode] is set to [D.Zoom].

**<NOTE>**

- Higher digital zoom magnifications will result in coarser images.

**Digital Extender [Off, On]**

Turn the digital extender function off/on.

When this is set to [On], the digital zoom will be fixed at 1.4x.

This is only enabled when [Zoom Mode] is set to [Opt.Zoom].

**OIS [Off, On]**

Turn the optical image stabilization (OIS) function off/on.

**<NOTE>**

- The optical image stabilization function's level of correction is reduced during pan/tilt operations.

**Return**

Return to the previous menu level.

**System screen**

## System ##	
↪ Frequency	59.94Hz
Format	2160/59.94p
Genlock	
Horizontal Phase	0
Horizontal Phase Step	1
Wireless Control	Enable
Fan	
Fan1	High
Fan2	High
Return	

**Frequency [59.94Hz, 50Hz, 24Hz, 23.98Hz]**

This item is selected to switch the frame frequency.

- For details on how to change the frequency, refer to “Changing the frequency” (→ page 55).

**Format**

**[For 59.94Hz]**

2160/59.94p, 2160/29.97p, 1080/59.94p, 1080/59.94i, 1080/29.97p, 1080/29.97PsF, 1080/23.98p(59.94i) \*1, 720/59.94p

**[For 50Hz]**

2160/50p, 2160/25p, 1080/50p, 1080/50i, 1080/25p, 1080/25PsF, 720/50p

**[For 24Hz]**

2160/24p, 1080/24p

**[For 23.98Hz]**

2160/23.98p, 1080/23.98p, 1080/23.98PsF

\*1 It denotes “1080/23.98p over 59.94i”.

- For details on how to change the format, refer to “Changing the format” (→ page 55).

**Genlock**

This item is selected to perform the phase adjustments.

**Horizontal Phase [-206 to +49]**

This is used to adjust the horizontal phase during genlock.

**Horizontal Phase Step [1 to 10]**

This is selected to set the amount by which the [Horizontal Phase] setting is to be adjusted.

**Wireless Control [Disable, Enable]**

[Enable] or [Disable] is set here for operations conducted from the wireless remote control.

The operations are enabled when the unit’s power is turned on from an external device other than a wireless remote control, and they are disabled when the power is turned on from a wireless remote control.

**Fan**

Set the cooling fan operation.

**Fan1 [Auto, Low, Mid, High]**

Set the operation of the cooling fan near the lens.

Auto	Enable automatic control of the cooling fan.
Low	Operate the cooling fan at low speed.
Mid	Operate the cooling fan at medium speed.
High	Operate the cooling fan at high speed.

**Fan2 [Auto, Low, Mid, High]**

Set the operation of the cooling fan near the pan-tilt head.

Auto	Enable automatic control of the cooling fan.
Low	Operate the cooling fan at low speed.
Mid	Operate the cooling fan at medium speed.
High	Operate the cooling fan at high speed.

**<NOTE>**

- Even if this is set to [Low], [Mid], or [High], the cooling fan may be forcibly stopped when the temperature is low.
- Even if this is set to [Low] or [Mid], the cooling fan may be forcibly operated at [High] when the temperature is high.

**Return**

Return to the previous menu level.

### ■ Changing the frequency

When the currently selected frequency is changed in the [System] screen, the pre-frequency-change confirmation screen appears.

#### Pre-frequency-change confirmation screen

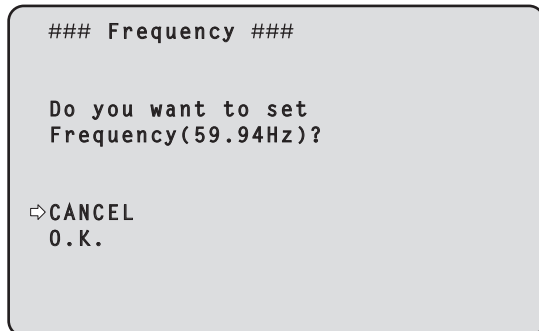

- The frequency to be set is displayed within the parentheses on the screen.
- When you move the cursor to [O.K.] on the pre-frequency-change confirmation screen and confirm, the frequency is changed.

#### <NOTE>

- When using a monitor that does not support 59.94Hz/50Hz/24Hz/23.98Hz frequencies, images may not be displayed after the frequency is changed. Before changing the frequency, verify that your monitor supports the frequency.

### ■ Changing the format

When the currently selected format is changed in the [System] screen, the pre-format-change confirmation screen appears.

#### Pre-format-change confirmation screen

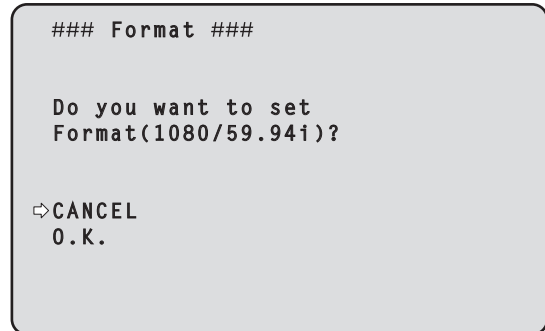

- The format to be set is displayed within the parentheses on the screen.
- When you move the cursor to [O.K.] on the pre-format-change confirmation screen and confirm, the post-format-change confirmation screen appears.

#### Post-format-change confirmation screen

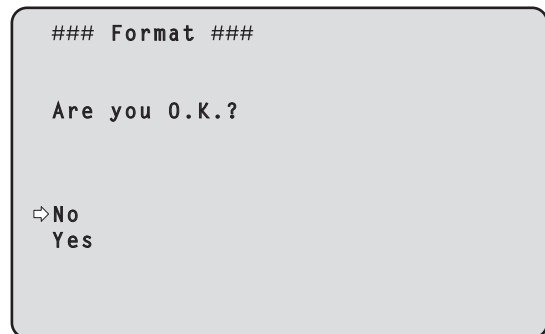

- If you move the cursor to [Yes] and confirm, the display returns to the [System] screen in the post-change format.
- If you move the cursor to [No] and confirm, the display returns to the [Output] screen in the pre-change format. The same occurs if an operation is not performed within 10 seconds.
- If an external sync signal that does not match the changed format is input, the image will be distorted. Change the external sync signal, or perform internal synchronization.

Output 1/6 screen

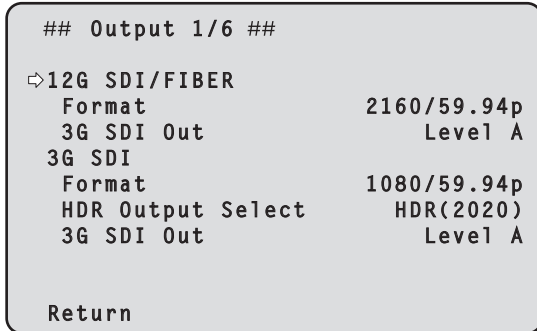

12G SDI/FIBER

Make the settings for output from the 12G SDI OUT connector and SFP+ 14G FIBER connector.

Format

Set the output format.

The following format settings are possible depending on the [System Format] setting.

Frequency	System Format	Format (12G SDI/FIBER)
59.94Hz	2160/59.94p	2160/59.94p
	2160/29.97p	2160/29.97p
	1080/59.94p	1080/59.94p
	1080/59.94i	1080/59.94i
	1080/29.97p	1080/29.97p
	1080/29.97PsF	1080/29.97PsF
	1080/23.98p(59.94i) *1	1080/23.98p(59.94i) *1
	720/59.94p	720/59.94p
50Hz	2160/50p	2160/50p
	2160/25p	2160/25p
	1080/50p	1080/50p
	1080/50i	1080/50i
	1080/25p	1080/25p
	1080/25PsF	1080/25PsF
	720/50p	720/50p
24Hz	2160/24p	2160/24p
	1080/24p	1080/24p
23.98Hz	2160/23.98p	2160/23.98p
	1080/23.98p	1080/23.98p
	1080/23.98PsF	1080/23.98PsF

\*1 It denotes "1080/23.98p over 59.94i".

3G SDI Out [Level A, Level B]

When [Format] (12G SDI/FIBER) is [1080/59.94p] or [1080/50p], select the format for outputting 3G SDI signals.

Level A	Level A format
Level B	Level B format

<NOTE>

- [3G SDI Out] cannot be changed if [Format] (12G SDI/FIBER) is other than [1080/59.94p] or [1080/50p].
- When [Gamma Mode] is [HLG], output is [HDR(2020)].

3G SDI

Make the settings for output from the 3G SDI OUT connector.

Format

Set the output format.

The following format settings are possible depending on the [System Format] setting.

Frequency	System Format	Format (3G SDI)
59.94Hz	2160/59.94p	1080/59.94p 1080/59.94i
	2160/29.97p	1080/29.97p 1080/29.97PsF
	1080/59.94p	1080/59.94p 1080/59.94i
	1080/59.94i	1080/59.94i
	1080/29.97p	1080/29.97p
	1080/29.97PsF	1080/29.97PsF
	1080/23.98p(59.94i) *1	1080/23.98p(59.94i) *1
	720/59.94p	720/59.94p
50Hz	2160/50p	1080/50p 1080/50i
	2160/25p	1080/25p 1080/25PsF
	1080/50p	1080/50p 1080/50i
	1080/50i	1080/50i
	1080/25p	1080/25p
	1080/25PsF	1080/25PsF
	720/50p	720/50p
24Hz	2160/24p	1080/24p
	1080/24p	1080/24p
23.98Hz	2160/23.98p	1080/23.98p 1080/23.98PsF
	1080/23.98p	1080/23.98p
	1080/23.98PsF	1080/23.98PsF

\*1 It denotes "1080/23.98p over 59.94i".

HDR Output Select [SDR, HDR(2020), HDR(709)]

Select the signal to be output when [Gamma Mode] is [HLG].

SDR	SDR output
HDR(2020)	HDR output (BT.2020 equivalent color gamut)
HDR(709)	HDR output (BT.709 equivalent color gamut)

<NOTE>

- [HDR Output Select] cannot be changed when [Gamma Mode] is not [HLG].

3G SDI Out [Level A, Level B]

When [Format] (3G SDI) is [1080/59.94p] or [1080/50p], select the format for outputting 3G SDI signals.

Level A	Level A format
Level B	Level B format

<NOTE>

- [3G SDI Out] cannot be changed if [Format] (3G SDI) is other than [1080/59.94p] or [1080/50p].

Return

Return to the previous menu level.



Output 2/6 screen

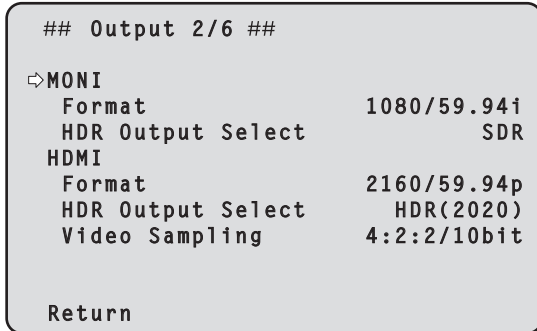

**MONI**

Make the settings for output from the MONITOR OUT connector <MONI OUT>.

**Format**

Set the output format.

The following format settings are possible depending on the [System Format] setting.

Frequency	System Format	Format (MONI)
59.94Hz	2160/59.94p	1080/59.94i
	2160/29.97p	1080/29.97p 1080/29.97PsF
	1080/59.94p	1080/59.94i
	1080/59.94i	1080/59.94i
	1080/29.97p	1080/29.97p
	1080/29.97PsF	1080/29.97PsF
	1080/23.98p(59.94i) *1	1080/23.98p(59.94i) *1
	720/59.94p	720/59.94p
50Hz	2160/50p	1080/50i
	2160/25p	1080/25p 1080/25PsF
	1080/50p	1080/50i
	1080/50i	1080/50i
	1080/25p	1080/25p
	1080/25PsF	1080/25PsF
	720/50p	720/50p
24Hz	2160/24p	1080/24p
	1080/24p	1080/24p
23.98Hz	2160/23.98p	1080/23.98p 1080/23.98PsF
	1080/23.98p	1080/23.98p
	1080/23.98PsF	1080/23.98PsF

\*1 It denotes "1080/23.98p over 59.94i".

**HDR Output Select [SDR, HDR(2020), HDR(709)]**

Select the signal to be output when [Gamma Mode] is [HLG].

SDR	SDR output
HDR(2020)	HDR output (BT.2020 equivalent color gamut)
HDR(709)	HDR output (BT.709 equivalent color gamut)

**<NOTE>**

- [HDR Output Select] cannot be changed when [Gamma Mode] is not [HLG].

**HDMI**

Make the settings for output from the HDMI connector.

**Format**

Set the output format.

The following format settings are possible depending on the [System Format] setting.

Frequency	System Format	Format (HDMI)
59.94Hz	2160/59.94p	2160/59.94p
	2160/29.97p	2160/29.97p
	1080/59.94p	1080/59.94p
	1080/59.94i	1080/59.94p
	1080/29.97p	1080/29.97p
	1080/29.97PsF	1080/29.97p
	1080/23.98p(59.94i) *1	1080/23.98p
	720/59.94p	720/59.94p
50Hz	2160/50p	2160/50p
	2160/25p	2160/25p
	1080/50p	1080/50p
	1080/50i	1080/50p
	1080/25p	1080/25p
	1080/25PsF	1080/25p
	720/50p	720/50p
24Hz	2160/24p	2160/24p
	1080/24p	1080/24p
23.98Hz	2160/23.98p	2160/23.98p
	1080/23.98p	1080/23.98p
	1080/23.98PsF	1080/23.98p

\*1 It denotes "1080/23.98p over 59.94i".

**HDR Output Select [SDR, HDR(2020), HDR(709)]**

Select the signal to be output when [Gamma Mode] is [HLG].

SDR	SDR output
HDR(2020)	HDR output (BT.2020 equivalent color gamut)
HDR(709)	HDR output (BT.709 equivalent color gamut)

**<NOTE>**

- [HDR Output Select] cannot be changed when [Gamma Mode] is not [HLG].

**Video Sampling [4:2:2/10bit, 4:2:0/8bit]**

When [Format] is [2160/59.94p] or [2160/50p], select the video sampling output from the HDMI connector.

4:2:2/10bit	Output in 4:2:2/10bit mode.
4:2:0/8bit	Output in 4:2:0/8bit mode.

**<NOTE>**

- [Video Sampling] cannot be changed if [Format] is other than [2160/59.94p] or [2160/50p].

**Return**

Return to the previous menu level.

**Output 3/6 screen**

## Output 3/6 ##	
↪Bar	Camera
Color Bar Type	Type2
Tone	Normal
Audio	Off
Input Type	Line
Volume Level	0dB
Plugin Power	Off
Return	

**Output 4/6 screen**

## Output 4/6 ##	
↪OSD Mix	
12G SDI/FIBER	Off
3G SDI	Off
MONI	On
HDMI	Off
IP	On
Return	

**Bar [Camera, Colorbar]**

Switch between camera images and color bars.

Camera	Camera images
Colorbar	Color bar

**Color Bar Type [Type1, Type2]**

Select the type of color bar to display.

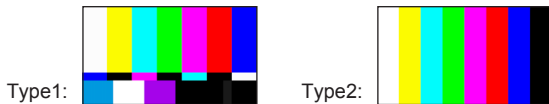

This is only enabled when [Bar] is set to [Colorbar].

**Tone [Off, Low, Normal]**

Make the settings for the test tone signal (1 kHz) output while the color bar is displayed.

Off	Test tone is not output.
Low	Test tone is output at low volume.
Normal	Test tone is output at normal volume.

This is only enabled when [Bar] is set to [Colorbar].

**Audio [Off, On]**

Turn audio input off/on.

**Input Type [Mic, Line]**

Mic	Set the microphone input.
Line	Set the line input.

This is only enabled when [Audio] is set to [On].

**Volume Level [-36dB to +12dB]**

Set the volume of audio output.

This is only enabled when [Audio] is set to [On].

**Plugin Power [Off, On]**

Turn the plugin power for the audio off/on.

This is only enabled when [Audio] is set to [On].

This is only enabled when [Input Type] is set to [Mic].

**Return**

Return to the previous menu level.

**OSD Mix**

Select whether to turn off/on camera menu, status, and other displays for each output image.

**12G SDI/FIBER [Off, On]**

**3G SDI [Off, On]**

**MONI [Off, On]**

**HDMI [Off, On]**

**IP [Off, On]**

Off	The camera menus and statuses are not displayed on the output pictures covered by the setting items listed above.
On	The camera menus and statuses are displayed for the output pictures covered by the setting items listed above.

**<NOTE>**

- When this is set to [Off], the camera menu can be displayed for about 1 minute after the unit is turned on.

**Return**

Return to the previous menu level.

**Output 5/6 screen**

## Output 5/6 ##	
⇨ OSD Off With R-Tally	Off
OSD Status	Off
Tally	Enable
Tally Brightness	Low
Status Lamp	Enable
External Output	
Output1	Off
Output2	Off
Return	

**OSD Off With R-Tally [Off, On]**

Off or on the function that turns off camera menu, status, and other displays when red tally signals are received via commands or contacts.

When the red tally signal releases, the camera menu display will return.

**OSD Status [Off, On]**

Turn the status display during AWB and ABB off/on, or error display when an error occurs.

**Tally [Disable, Enable]**

[Disable] or [Enable] is set here for the function which turns on or turns off the tally lamp using the tally control signal.

**Tally Brightness [Low, Mid, High]**

Adjust the brightness of the tally LED.

**Status Lamp [Disable, Enable]**

[Disable] or [Enable] is set here for the status display lamp. When you want the status display lamp to stay off while this unit is in operation, set to [Disable].

**<NOTE>**

- Even when set to [Disable], the status display lamp may light up when this unit is starting up, updating firmware, or trouble is occurring.

**External Output**

Select the signal type output from the External Output signal lines (Output1, Output2) of the RS-422 cable.

**Output1 [Off, R-Tally, G-Tally]**

**Output2 [Off, R-Tally, G-Tally]**

Off	Signal is not output.
R-Tally	High is output when receiving the red tally signal.
G-Tally	High is output when receiving the green tally signal.

**Return**

Return to the previous menu level.

**Output 6/6 screen**

## Output 6/6 ##	
⇨ UHD Crop	Off
3G SDI/IP Out	Crop
Crop Out	YL
Crop Marker	YL+G+MG
Crop Adjust	YL
Crop H Position	960
Crop V Position	540
Return	

**UHD Crop [Off, On]**

Switch off/on the crop function which crops UHD (3840 × 2160) images to FHD (1920 × 1080) images.

This is enabled only when [Format] in [System] is the following.

- 2160/59.94p, 2160/29.97p
- 2160/50p, 2160/25p
- 2160/24p, 2160/23.98p

**3G SDI/IP Out [Full, Crop]**

Make the settings for Full/Crop for images output to the 3G SDI OUT connector and IP.

Full	FHD down-converted images are output as is without cropping UHD images.
Crop	Images with FHD cropped from UHD images are output. The images output in this case are those with the crop frame specified in [Crop Out].

This is only enabled when [UHD Crop] is set to [On].

**Crop Out [YL, G, MG]**

Make the settings for the crop frame for images output to the 3G SDI OUT connector and IP.

YL	Output the yellow crop frame images.
G	Output the green crop frame images.
MG	Output the magenta crop frame images.

This is only enabled when [UHD Crop] is set to [On].

**Crop Marker [Off, YL, G, MG, YL+G, YL+MG, G+MG, YL+G+MG]**

Make the settings for the crop frame displayed for images output to the MONI OUT connector.

Off	Crop frame is not displayed.
YL	Only a yellow crop frame is displayed.
G	Only a green crop frame is displayed.
MG	Only a magenta crop frame is displayed.
YL+G	Yellow and green crop frames are displayed.
YL+MG	Yellow and magenta crop frames are displayed.
G+MG	Green and magenta crop frames are displayed.
YL+G+MG	Yellow, green, and magenta crop frames are displayed.

This is only enabled when [UHD Crop] is set to [On].

**Crop Adjust [YL, G, MG]**

Make selections for the crop frame to adjust positioning.

YL	Make position adjustments for the yellow crop frame.
G	Make position adjustments for the green crop frame.
MG	Make position adjustments for the magenta crop frame.

This is only enabled when [UHD Crop] is set to [On].

## Camera menu items (continued)

### Crop H Position [0 to 1920]

Make settings for the position in the horizontal direction for the crop frame specified in [Crop Adjust].

0 is the left edge and 1920 is the right edge.

This is only enabled when [UHD Crop] is set to [On].

### Crop V Position [0 to 1080]

Make settings for the position in the vertical direction for the crop frame specified in [Crop Adjust].

0 is the upper edge and 1080 is the lower edge.

This is only enabled when [UHD Crop] is set to [On].

### Return

Return to the previous menu level.

## ■ The CROP function

When [UHD Crop] is set to [On], it is possible to output images with FHD cropped from UHD signals from the 3G SDI OUT connector and IP.

(Image 2)

Video signals of UHD images down-converted to FHD are output to the MONITOR OUT connector <MONI OUT> at this time, and the crop frame is displayed. (Image 1)

Furthermore, UHD images are output from the 12G SDI OUT connector, SFP+ 14G FIBER connector, and HDMI connector, and the crop frame is not displayed.

Crop frame



Image 1

Image 2

Depending on the [3G SDI/IP Out] and [Crop Out] settings, images output from the 3G SDI OUT connector and IP will be as shown below.

3G SDI/IP Out	Crop Out	Images output from 3G SDI OUT connector and IP
Full	–	UHD images down-converted to FHD
Crop	YL	Yellow frame FHD crop images
	G	Green frame FHD crop images
	MG	Magenta frame FHD crop images



Depending on the [Crop Marker] setting, it is possible to select the crop frame output to the MONITOR OUT connector <MONI OUT>.

Crop Marker	Crop frame display
Off	Crop frame is not displayed.
YL	Only a yellow crop frame is displayed.
G	Only a green crop frame is displayed.
MG	Only a magenta crop frame is displayed.
YL+G	Yellow and green crop frames are displayed.
YL+MG	Yellow and magenta crop frames are displayed.
G+MG	Green and magenta crop frames are displayed.
YL+G+MG	Yellow, green, and magenta crop frames are displayed.

## Pan/Tilt screen

## Pan/Tilt ##	
⇨ Install Position	Desktop
Smart Picture Flip	Off
Flip Detect Angle	90deg
P/T Speed Mode	Normal
Speed With Zoom Position	On
Focus Adjust With PTZ.	Off
Return	

### Install Position [Desktop, Hanging]

[Desktop] or [Hanging] is selected here as the method used to install the unit.

Desktop	Stand-alone installation
Hanging	Suspended installation

#### <NOTE>

- When [Hanging] has been selected, the top, bottom, left and right of the images will be reversed, and up/down/left/right control for panning and tilting will also be reversed.

### Smart Picture Flip [Off, Auto]

When the tilt becomes the angle set for [Flip Detect Angle], the image will be flipped in the vertical direction automatically.

Off	The picture is not turned upside down.
Auto	The picture is automatically turned upside down.

### Flip Detect Angle [60deg to 120deg]

Set the tilt angle at which the image will be flipped in the vertical direction automatically when [Smart Picture Flip] is set to [Auto].

### P/T Speed Mode [Normal, Fast]

Set the speed of pan/tilt operation.

Normal	Pan/tilt operates at normal speed (maximum about 60° per second).
Fast	Pan/tilt operates at fast speed (maximum about 200° per second).

#### <NOTE>

- The pan/tilt operation noise may increase when [Fast] is selected.
- Even when [Fast] is selected, the pan/tilt speed during preset playback will be the same speed as when [Normal] is selected.

### Speed With Zoom Position [Off, On]

[Off] or [On] is set here for the function used to adjust the pan/tilt adjustment speed in conjunction with the zoom magnification.

When [On] is set, the panning and tilting operations will become slower in the zoom status.

This function has no effect during preset operations.

### Focus Adjust With PTZ. [Off, On]

[Off] or [On] is set here for the function which compensates for out-of-focusing when it occurs during panning, tilting or zooming operations.

When [Off] is set, adjust the focus as required after zooming or set [Focus Mode] to [Auto].

This is only enabled when [Manual] has been selected as the [Focus Mode] setting.

### Return

Return to the previous menu level.

**Preset 1/2 screen**

```

## Preset 1/2 ##
⏪ Preset Speed Unit      Speed Table
Preset Speed Table      Fast
Preset Speed             20
Preset Scope             Mode A
Preset Digital Extender  Off
Preset Crop              Off
Preset Thumbnail Update  On
Preset Name              Reset

Return
    
```

**Preset Speed Unit [Speed Table, Time]**

When reproducing the information such as camera direction registered in the preset memory, you can select whether to specify the playback time by speed or by time.

Speed Table	Specify the speed when playing during preset playback.
Time	Specify the time when playing during preset playback.

**Preset Speed Table [Slow, Fast]**

Set the preset speed table (Slow, Fast). During preset playback, presets are performed at [Preset Speed] (1 to 30) values that are based on the table set here.

This is only enabled when [Preset Speed Unit] is set to [Speed Table].

**Preset Speed [1 to 30/1s to 99s]**

**When [Preset Speed Unit] is [Speed Table]: [1 to 30]**

Set the pan/tilt operation speed in 30 steps when playing back the preset memory.

**<NOTE>**

- When you set large [Preset Speed] values, the image may sway when the movement stops.

**When [Preset Speed Unit] is [Time]: [1s to 99s]**

Set the pan/tilt operation time between 1 and 99 seconds when playing back the preset memory.

**<NOTE>**

- Depending on the movement distance of pan/tilt, there may be a difference compared to the specified time.

**Preset Scope [Mode A, Mode B, Mode C]**

Selected here are the setting items to be recalled when the contents of the preset memory are regenerated.

Mode A	Pan, Tilt, Zoom (including digital zoom), Focus, Iris, Gain, white balance adjustment value
Mode B	Pan, Tilt, Zoom (including digital zoom), Focus, Iris
Mode C	Pan, Tilt, Zoom (including digital zoom), Focus

**Preset Digital Extender [Off, On]**

Turns the preset digital extender function off/on.

When set to [On], the digital extender function configuration will be recalled when regenerating the preset memory.

When set to [Off], the digital extender function configuration will not be recalled when storing the preset memory.

**Preset Crop [Off, On]**

When the preset memory is played back, set whether the reproduction of content set in the various [UHD Crop] menus is off/on. When set to [On], the content set in the various [UHD Crop] menus is reproduced when preset memory is played back.

When set to [Off], the content set in the various [UHD Crop] menus is not reproduced when preset memory is played back, with the current values being kept.

**Preset Thumbnail Update [Off, On]**

Turn off/on the function for registering the still image (thumbnail) for the images being output when a preset memory is registered.

When set to [On], the still image (thumbnail) for the images being output is registered when registering a preset memory.

When set to [Off], the still image (thumbnail) for the images being output is not registered when registering a preset memory, and a black screen is registered.

**<NOTE>**

- The registered still image (thumbnail) is registered as the still image for images output by IP transmission. For example, when [UHD Crop] is [On], the cropped still image is registered rather than the Full image.

**Preset Name [Reset, Hold]**

When registering a preset memory, set whether to reset the previously registered preset name or keep it.

Reset	When registering a preset memory, reset the previously registered preset name. The preset name after resetting will be [PRESET***]. (***) is a 3 digit preset number: 001 to 100
Hold	When registering a preset memory, keep the previously registered preset name.

**<NOTE>**

- The factory default setting for the preset name is [PRESET\*\*\*]. (\*\*\*) is a 3 digit preset number: 001 to 100
- The registration of preset names can be done in the web browser (XX page) or from the controller (AW-RP150).
- The maximum length of preset names is 15 characters, with the following characters available for use: 0 to 9, A to Z, a to z, - . \_ , + / ( ) [ ] (and space)

**Return**

Return to the previous menu level.

**Preset 2/2 screen**

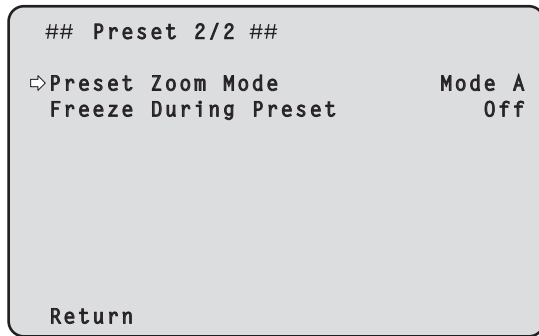

**Maintenance screen**

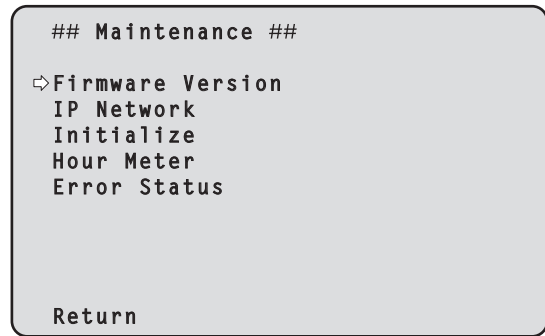

**Preset Zoom Mode [Mode A, Mode B]**

Select the zoom operation for when preset memory is recalled.

Mode A	Perform the zoom operation in line with the pan/tilt operation.
Mode B	Perform the zoom operation quicker than the pan/tilt operation.

**Freeze During Preset [Off, On]**

Turn the function for freezing images during preset playback off/on. When this is set to [On], preset playback is performed with a still of the image immediately preceding the start of preset playback being output. The image freeze is released when preset playback is finished.

**Return**

Return to the previous menu level.

**Firmware Version**

This is selected to display the [Firmware Version] screen on which the user can check the version of the firmware which is currently installed in the unit.

**IP Network**

This is selected to display the [IP Network] screen on which the user can check the [IP Address], [Subnet Mask] and [Default Gateway] settings which have been established in the unit.

**Initialize**

This is selected to display the [Initialize] screen on which the user can initialize the camera settings. For details on operation, refer to “Concerning initialization” (→ page 64).

**Hour Meter**

This is selected to display the [Hour Meter] screen on which the operation history is displayed.

**Error Status**

Display the [Error Status] screen that displays the status of errors.

**Return**

Return to the previous menu level.

### Firmware Version 1/2 screen

```
### Firmware Version 1/2 ###
System Version          V01.00
CPU Software
  Main/Network          V01.00
  Camera                V01.00
  Lens                  V01.00
  Servo                 V01.00
  Interface              V01.00
⇨ Return
```

#### System Version

Display the version for overall system of the unit.

#### CPU Software

##### Main/Network

Display the main/network software version.

##### Camera

Display the software version of the camera.

##### Lens

Display the software version of the lens.

##### Servo

Display the software version of the servo.

##### Interface

Display the software version of the interface.

#### Return

Return to the previous menu level.

### Firmware Version 2/2 screen

```
### Firmware Version 2/2 ###
EEPROM
  Main/Network          V01.00
  Interface              V01.00
FPGA
  COM                   V01.00
  AVIO                  V01.00
⇨ Return
```

#### EEPROM

##### Main/Network

Display the EEPROM version of the main/network.

##### Interface

Display the EEPROM version of the interface.

#### FPGA

##### COM

Display the FPGA version for communications.

##### AVIO

Display the FPGA version for image processing.

#### Return

Return to the previous menu level.

### IP Network screen

```
### IP Network ###  
  
IP Address           192.168.0.10  
  
Subnet Mask         255.255.255.0  
  
Default Gateway     192.168.0.1  
  
⇨ Return
```

#### IP Address

This is selected to display the IP address which has been set for the unit.

#### Subnet Mask

This is selected to display the subnet mask which has been set for the unit.

#### Default Gateway

This is selected to display the default gateway which has been set for the unit.

#### Return

Return to the previous menu level.

#### <NOTE>

- On this screen, the [IP Address], [Subnet Mask] and [Default Gateway] settings can be displayed but they cannot be changed. To change an address, use "Displaying the web screen" (→ page 72) or "Use the Easy IP Setup Software to establish the unit's settings" (→ page 27).

## ■ Concerning initialization

When [Initialize] is selected on the [Maintenance] screen, the [Initialize] screen appears.

### Initialize screen

```
### Initialize ###  
  
Do you want to initialize  
Menu settings?  
  
⇨ CANCEL  
O.K.
```

- When the cursor is moved to [O.K.] on the [Initialize] screen and the setting is entered, the [Menu settings initialized] screen is displayed for 5 seconds, and the camera settings are restored to the settings which were established when the camera was purchased. However, the [Format] settings and [Frequency] settings (→ page 54) and network settings are not initialized.

#### <NOTE>

- Operation returns to the [Top Menu] screen when the initialization operation is completed. At this point, set the unit to the Standby mode, and then set it to the Power ON mode again. (→ page 29)
- The [Format] and [Frequency] settings are not initialized.
- The [AWB] and [ABB] adjustment values are not initialized.

### Menu settings initialized screen

```
Menu settings  
initialized
```

- When the cursor is moved to [CANCEL] on the [Initialize] screen and the setting is entered, the [Menu settings unchanged] screen is displayed for 5 seconds, the initialization operation is not performed, and the [Maintenance] screen returns to the display.

### Menu settings unchanged screen

```
Menu settings  
unchanged
```



**Hour Meter screen**

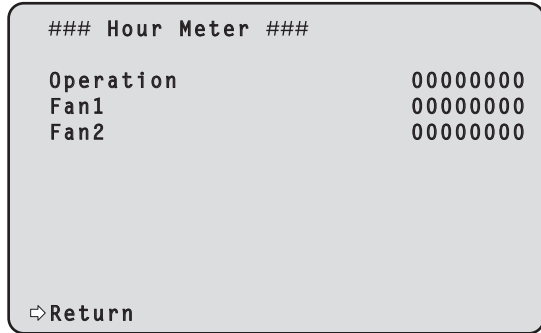

**Operation**

Displays the cumulative time that power has been supplied to the unit. (8-digit numerical value)

**Fan1**

Display the cumulative hours of operation of the cooling fan near the lens. (8-digit numerical value)

**Fan2**

Display the cumulative hours of operation of the cooling fan near the pan-tilt head. (8-digit numerical value)

**Return**

Return to the previous menu level.

**Error Status screen**

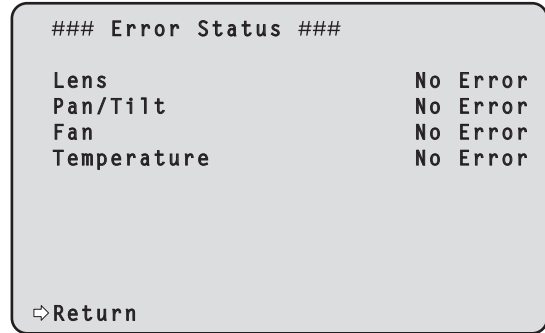

**Lens [No Error, Error]**

This displays the error status of the lens.

No Error	The lens is operating normally.
Error	A lens error has occurred.

**Pan/Tilt [No Error, Error]**

This displays the error status of the pan-tilt drive section.

No Error	The pan-tilt drive section is operating normally.
Error	A pan-tilt drive section error has occurred.

**Fan [No Error, Error]**

This displays the error status of the fan.

No Error	The fan is operating normally.
Error	A fan error has occurred.

**Temperature [No Error, High Temperature, Sensor Error]**

This displays the status of temperature related errors.

No Error	Within normal operating temperature range.
High Temperature	Temperature is high.
Sensor Error	The temperature sensor may have malfunctioned.

**Return**

Return to the previous menu level.

# Camera menu item table

Camera menu			Item	Factory setting	Selection items	
Top Menu	Camera	Scene	Scene	Scene1	Scene1, Scene2, Scene3, Scene4	
		Brightness	Brightness 1/2	Picture Level	0	-50 to +50 (step: 1)
				Iris Mode	Auto	Manual, Auto
				Auto Iris Speed	Normal	Slow, Normal, Fast
				Auto Iris Window	Normal1	Normal1, Normal2, Center
				Shutter Mode	Off	Off, Step, Synchro, ELC
				Step/Synchro (When [Shutter Mode] is set to [Step])	[59.94Hz] 1/100 [50Hz] 1/120	<ul style="list-style-type: none"> <li>• 59.94p/59.94i mode 1/60, 1/100, 1/120, 1/250, 1/500, 1/1000, 1/2000, 1/4000, 1/8000, 1/10000</li> <li>• 29.97p mode 1/30, 1/60, 1/100, 1/120, 1/250, 1/500, 1/1000, 1/2000, 1/4000, 1/8000, 1/10000</li> <li>• 23.98p/24p mode 1/24, 1/48, 1/60, 1/100, 1/120, 1/250, 1/500, 1/1000, 1/2000, 1/4000, 1/8000, 1/10000</li> <li>• 50p/50i mode 1/60, 1/100, 1/120, 1/250, 1/500, 1/1000, 1/2000, 1/4000, 1/8000, 1/10000</li> <li>• 25p mode 1/25, 1/50, 1/60, 1/100, 1/120, 1/250, 1/500, 1/1000, 1/2000, 1/4000, 1/8000, 1/10000</li> </ul>
				Step/Synchro (When [Shutter Mode] is set to [Synchro])	[59.94Hz] 60.0Hz [50Hz] 50.0Hz	<ul style="list-style-type: none"> <li>• 59.94p/59.94i mode 60.0 Hz to 7200 Hz</li> <li>• 29.97p mode 30.0 Hz to 7200 Hz</li> <li>• 23.98p/24p mode 24.0 Hz to 7200 Hz</li> <li>• 50p/50i mode 50.0 Hz to 7200 Hz</li> <li>• 25p mode 25.0 Hz to 7200 Hz</li> </ul>
				ELC Limit (When [Shutter Mode] is set to [ELC])	1/250	1/100, 1/120, 1/250
		Brightness	Brightness 2/2	Gain	0dB	<b>(When [Super Gain] is set to [On])</b> Auto, 0dB to 42dB (step: 1dB) <b>(When [Super Gain] is set to [Off])</b> Auto, 0dB to 36dB (step: 1dB)
				Super Gain	Off	Off, On
				AGC Max Gain	18dB	6dB, 12dB, 18dB
				Frame Mix	Off	Off, 6dB, 12dB, 18dB, 24dB
				ND Filter	Through	Through, 1/4, 1/16, 1/64
				Day/Night	Day	Day, Night
		Picture	Picture 1/8	White Balance Mode	AWB A	AWB A, AWB B, ATW, 3200K, 5600K, VAR
				Color Temperature	3200K	2000K to 15000K
				R Gain	0	-200 to +200
				B Gain	0	-200 to +200
				AWB Gain Offset	Off	Off, On
				ATW Speed	Normal	Normal, Slow, Fast
				ATW Target R	0	-10 to +10
				ATW Target B	0	-10 to +10
			Picture 2/8	Chroma Level	0%	Off, -99% to 99% (step: 1%)
				Chroma Phase	0	-31 to +31
				Master Pedestal	0	-200 to +200 (step: 1)
				R Pedestal	0	-100 to +100 (step: 1)
				G Pedestal	0	-100 to +100 (step: 1)
				B Pedestal	0	-100 to +100 (step: 1)
				Pedestal Offset	Off	Off, On

Camera menu item table (continued)

Camera menu				Item	Factory setting	Selection items					
Top Menu	Camera	Scene	Picture	Picture 3/8	Detail	On	Off, On				
					Master Detail	0	-31 to +31				
					Detail Coring	0	0 to 60				
					V Detail Level	0	-7 to +7				
					Detail Frequency	0	-7 to +7				
					Level Depend.	0	-7 to +7				
					Knee Aperture Level	1	0 to 5				
					Detail Gain(+)	0	-31 to +31				
					Detail Gain(-)	0	-31 to +31				
				Picture 4/8	Skin Detail	Off	Off, On				
					Skin Detail Effect	16	0 to 31				
				Picture 5/8	DownCon Detail	On	Off, On				
					DC. Master Detail	0	-31 to +31				
					DC. Detail Coring	0	0 to 60				
					DC. V Detail Level	0	-7 to +7				
					DC. Detail Frequency	0	-2 to +2				
					DC. Level Depend.	0	-7 to +7				
				Picture 6/8	Gamma Mode	HD	HD, FILMLIKE1, FILMLIKE2, FILMLIKE3, FILM REC, VIDEO REC, HLG				
					Gamma	0.45	0.30 to 0.75 (Step: 0.01)				
					F-REC Dynamic Level	500%	200%, 300%, 400%, 500%, 600%				
					F-REC Black STR. Level	0%	0% to 30% (Step: 1%)				
					V-REC Knee Slope	150%	150%, 200%, 250%, 300%, 350%, 400%, 450%, 500%				
					V-REC Knee Point	30%	30% to 107% (Step: 1%)				
					Black Gamma	0	-8 to +8				
					Black Gamma Range	1	1 to 3				
					DRS	Off	Off, Low, Mid, High				
				Picture 7/8	Knee Mode	Auto	Off, Auto, Manual				
					Auto Knee Response	4	1 to 8				
					Knee Point	93.0%	70.0% to 107.0% (Step: 0.5%)				
					Knee Slope	85	0 to 99				
					HLG Knee	Off	Off, On				
					HLG Knee Point	80%	55% to 109% (Step: 1%)				
				Picture 8/8	White Clip	On	Off, On				
					White Clip Level	109%	90% to 109% (Step: 1%)				
					DNR	Off	Off, Low, High				
				Matrix	Matrix 1/5	Matrix Type	Normal	Normal, EBU, NTSC, User			
					Matrix 2/5	[Linear Matrix]	Normal	EBU	NTSC	User	
						R-G	0	0	0	0	-63 to +63
						R-B	0	0	0	0	-63 to +63
						G-R	0	0	0	0	-63 to +63
						G-B	0	0	0	0	-63 to +63
						B-R	0	0	0	0	-63 to +63
						B-G	0	0	0	0	-63 to +63

Camera menu item table (continued)

Camera menu				Item	Factory setting				Selection items		
Top Menu	Camera	Scene	Matrix	Matrix 3/5	[Color Correction 1/3]	Normal	EBU	NTSC	User		
					B_Mg Saturation	-27	-21	-7	-14	-63 to +63	
					B_Mg Phase	+19	+4	-38	-5	-63 to +63	
					Mg Saturation	-19	0	0	-9	-63 to +63	
					Mg Phase	+10	0	0	-9	-63 to +63	
					Mg_R Saturation	-63	-63	-8	-29	-63 to +63	
					Mg_R Phase	-4	+13	+13	0	-63 to +63	
					Mg_R_R Saturation	-48	-13	-62	-34	-63 to +63	
					Mg_R_R Phase	-27	+63	0	0	-63 to +63	
					R Saturation	-9	-63	-37	-18	-63 to +63	
					R Phase	-4	0	+4	-4	-63 to +63	
					R_R_YI Saturation	+62	-32	+12	+24	-63 to +63	
					R_R_YI Phase	+23	+38	+63	-16	-63 to +63	
					Matrix 4/5	[Color Correction 2/3]	Normal	EBU	NTSC	User	
						R_YI Saturation	+63	+18	-63	+17	-63 to +63
				R_YI Phase		+44	+35	+9	-13	-63 to +63	
				R_YI_YI Saturation		+44	0	0	+9	-63 to +63	
				R_YI_YI Phase		0	0	+17	-8	-63 to +63	
				YI Saturation		+63	+63	+14	+19	-63 to +63	
				YI Phase		+29	+4	-7	-2	-63 to +63	
				YI_YI_G Saturation						-63 to +63	
				YI_YI_G Phase						-63 to +63	
				YI_G Saturation		+17	+9	0	+16	-63 to +63	
				YI_G Phase		+20	+22	+16	-2	-63 to +63	
				G Saturation		+4	+12	+56	-2	-63 to +63	
				G Phase		+26	+4	+13	-4	-63 to +63	
				Matrix 5/5		[Color Correction 3/3]	Normal	EBU	NTSC	User	
						G_Cy Saturation	0	0	0	0	-63 to +63
					G_Cy Phase	0	0	0	-9	-63 to +63	
					Cy Saturation	-21	+18	-28	-9	-63 to +63	
					Cy Phase	+8	+24	+33	+5	-63 to +63	
					Cy_B Saturation	-15	-17	-63	-12	-63 to +63	
					Cy_B Phase	+49	+61	+63	+5	-63 to +63	
	B Saturation	-12	-8		-17	-19	-63 to +63				
	B Phase	+3	+7		-8	0	-63 to +63				
	Lens	Focus Mode	Auto			Manual, Auto					
		Zoom Mode	Opt.Zoom			Opt.Zoom, i.Zoom, D.Zoom					
		Max Digital Zoom	x10			x2 to x10 (Step: 1)					
		Digital Extender	Off			Off, On					
		OIS	Off			Off, On					
		System	Frequency	59.94Hz			59.94Hz, 50Hz, 24Hz, 23.98Hz				
	Format		2160/59.94p			<b>(When [Frequency] is set to [59.94Hz])</b> 2160/59.94p, 2160/29.97p, 1080/59.94p, 1080/59.94i, 1080/29.97p, 1080/29.97PsF, 1080/23.98p(59.94i)*1, 720/59.94p <b>(When [Frequency] is set to [50Hz])</b> 2160/50p, 2160/25p, 1080/50p, 1080/50i, 1080/25p, 1080/25PsF, 720/50p <b>(When [Frequency] is set to [24Hz])</b> 2160/24p, 1080/24p <b>(When [Frequency] is set to [23.98Hz])</b> 2160/23.98p, 1080/23.98p, 1080/23.98PsF					
	Genlock										
	Horizontal Phase		0			-206 to +49					
	Horizontal Phase Step		1			1 to 10					
	Wireless Control		Enable			Enable, Disable					
	Fan										
	Fan1		High			Auto, Low, Mid, High					
	Fan2		High			Auto, Low, Mid, High					

\*1 It denotes "1080/23.98p over 59.94i".

Camera menu item table (continued)

Camera menu		Item	Factory setting	Selection items		
Top Menu	Output	Output 1/6	12G SDI/FIBER			
			Format	2160/59.94p	<b>[System Format]</b> 2160/59.94p 2160/29.97p 1080/59.94p 1080/59.94i 1080/29.97p 1080/29.97PsF 1080/23.98p(59.94i)*1 720/59.94p 2160/50p 2160/25p 1080/50p 1080/50i 1080/25p 1080/25PsF 720/50p 2160/24p 1080/24p 2160/23.98p 1080/23.98p 1080/23.98PsF	<b>[12G SDI/FIBER]</b> 2160/59.94p 2160/29.97p 1080/59.94p 1080/59.94i 1080/29.97p 1080/29.97PsF 1080/23.98p(59.94i)*1 720/59.94p 2160/50p 2160/25p 1080/50p 1080/50i 1080/25p 1080/25PsF 720/50p 2160/24p 1080/24p 2160/23.98p 1080/23.98p 1080/23.98PsF
			3G SDI Out	Level A	Level A, Level B	
			3G SDI			
			Format	1080/59.94p	<b>[System Format]</b> 2160/59.94p 2160/29.97p 1080/59.94p 1080/59.94i 1080/29.97p 1080/29.97PsF 1080/23.98p(59.94i)*1 720/59.94p 2160/50p 2160/25p 1080/50p 1080/50i 1080/25p 1080/25PsF 720/50p 2160/24p 1080/24p 2160/23.98p 1080/23.98p 1080/23.98PsF	<b>[3G SDI]</b> 1080/59.94p 1080/59.94i 1080/29.97p 1080/29.97PsF 1080/59.94p 1080/59.94i 1080/29.97p 1080/29.97PsF 1080/23.98p(59.94i)*1 720/59.94p 1080/50p 1080/50i 1080/25p 1080/25PsF 1080/50p 1080/50i 1080/50i 1080/25p 1080/25PsF 720/50p 1080/24p 1080/24p 1080/23.98p 1080/23.98PsF 1080/23.98p 1080/23.98PsF
			HDR Output Select	HDR(2020)	SDR, HDR(2020), HDR(709)	
			3G SDI Out	Level A	Level A, Level B	

\*1 It denotes "1080/23.98p over 59.94i".

Camera menu item table (continued)

Camera menu		Item	Factory setting	Selection items	
Top Menu	Output	Output 2/6	MONI		
			Format	1080/59.94i	<b>[System Format]</b> 2160/59.94p 2160/29.97p  1080/59.94p 1080/59.94i 1080/29.97p 1080/29.97PsF 1080/23.98p(59.94i)*1 720/59.94p 2160/50p 2160/25p  1080/50p 1080/50i 1080/25p 1080/25PsF 720/50p 2160/24p 1080/24p 2160/23.98p  1080/23.98p 1080/23.98PsF
		HDR Output Select	SDR	SDR, HDR(2020), HDR(709)	
		HDMI			
		Format	2160/59.94p	<b>[System Format]</b> 2160/59.94p 2160/29.97p 1080/59.94p 1080/59.94i 1080/29.97p 1080/29.97PsF 1080/23.98p(59.94i)*1 720/59.94p 2160/50p 2160/25p 1080/50p 1080/50i 1080/25p 1080/25PsF 720/50p 2160/24p 1080/24p 2160/23.98p 1080/23.98p 1080/23.98PsF	<b>[HDMI]</b> 2160/59.94p 2160/29.97p 1080/59.94p 1080/59.94p 1080/29.97p 1080/29.97p 1080/23.98p 720/59.94p 2160/50p 2160/25p 1080/50p 1080/50p 1080/25p 1080/25p 720/50p 2160/24p 1080/24p 2160/23.98p 1080/23.98p 1080/23.98p
		HDR Output Select	HDR(2020)	SDR, HDR(2020), HDR(709)	
		Video Sampling	4:2:2/10bit	4:2:2/10bit, 4:2:0/8bit	
		Output 3/6	Bar	Camera	Camera, Colorbar
			Color Bar Type	Type2	Type1, Type2
			Tone	Normal	Off, Low, Normal
			Audio	Off	Off, On
			Input Type	Line	Mic, Line
			Volume Level	0dB	-36dB to +12dB (Step: 3dB)
			Plugin Power	Off	Off, On
		Output 4/6	OSD Mix		
			12G SDI/FIBER	Off	Off, On
			3G SDI	Off	Off, On
			MONI	On	Off, On
			HDMI	Off	Off, On
			IP	On	Off, On

\*1 It denotes "1080/23.98p over 59.94i".

Camera menu item table (continued)

Camera menu		Item	Factory setting	Selection items			
Top Menu	Output	Output 5/6	OSD Off With R-Tally	Off	Off, On		
			OSD Status	Off	Off, On		
			Tally	Enable	Enable, Disable		
			Tally Brightness	Low	Low, Mid, High		
			Status Lamp	Enable	Enable, Disable		
			External Output				
			Output1	Off	Off, R-Tally, G-Tally		
		Output2	Off	Off, R-Tally, G-Tally			
		Output 6/6	UHD Crop	Off	Off, On		
			3G SDI/IP Out	Crop	Full, Crop		
			Crop Out	YL	YL, G, MG		
			Crop Marker	YL+G+MG	Off, YL, G, MG, YL+G, YL+MG, G+MG, YL+G+MG		
			Crop Adjust	YL	YL, G, MG		
			Crop H Position	960	0 to 1920		
	Crop V Position		540	0 to 1080			
	Pan/Tilt	Install Position		Desktop	Desktop, Hanging		
		Smart Picture Flip		Off	Off, Auto		
		Flip Detect Angle		90deg	60deg to 120deg (Step: 1deg)		
		P/T Speed Mode		Normal	Normal, Fast		
		Speed With Zoom Position		On	Off, On		
		Focus Adjust With PTZ.		Off	Off, On		
	Preset	Preset 1/2	Preset Speed Unit	Speed Table	Speed Table, Time		
			Preset Speed Table	Fast	Slow, Fast		
			Preset Speed (When [Preset Speed Unit] is set to [Speed Table])	20	1 to 30		
			Preset Speed (When [Preset Speed Unit] is set to [Time])	20s	1s to 99s		
			Preset Scope	Mode A	Mode A, Mode B, Mode C		
			Preset Digital Extender	Off	Off, On		
			Preset Crop	Off	Off, On		
Preset Thumbnail Update			On	Off, On			
Preset Name			Reset	Reset, Hold			
Preset 2/2			Preset Zoom Mode	Mode A	Mode A, Mode B		
		Freeze During Preset	Off	Off, On			
		Firmware Version					
		IP Network					
Maintenance		Firmware Version	Firmware Version 1/2	System Version	Version at shipping	---	
	CPU Software						
	Main/Network			Version at shipping	---		
	Camera			Version at shipping	---		
	Lens			Version at shipping	---		
	Servo			Version at shipping	---		
	Interface			Version at shipping	---		
	Firmware Version 2/2		EEPROM				
			Main/Network	Version at shipping	---		
			Interface	Version at shipping	---		
			FPGA				
			COM	Version at shipping	---		
	AVIO		Version at shipping	---			
	IP Network		IP Address		192.168.0.10		
		Subnet Mask		255.255.255.0			
		Default Gateway		192.168.0.1			
	Initialize	---		CANCEL	CANCEL, OK		
	Hour Meter	Operation		00000000	---		
		Fan1		00000000	---		
		Fan2		00000000	---		
	Error Status	Lens		No Error	No Error, Error		
		Pan/Tilt		No Error	No Error, Error		
Fan		No Error	No Error, Error				
Temperature		No Error	No Error, High Temperature, Sensor Error				

# Displaying the web screen

With a personal computer connected to the unit, it is possible to view the camera's IP videos or select various settings from the web browser.

The LAN crossover cable is used when connecting a personal computer directly to the unit's LAN connector for IP control, and the LAN straight cable is used when making the connection through a switching hub.

Select an IP address for the personal computer within the private address range while ensuring that it is different from the address of the unit. Set the subnet mask to the same address as the unit.

### <NOTE>

- If you need to change the IP address and subnet mask, be sure to ask your dealer to make these changes for you.

### Unit's IP address and subnet mask (factory settings)\*1

IP address: 192.168.0.10  
Subnet mask: 255.255.255.0

\*1 The factory default for the private address range is between 192.168.0.1 and 192.168.0.255.

- If the controller and web browser are being used at the same time, the content selected using the controller may not be reflected on the web browser display. When using both the controller and web browser, be absolutely sure to check the settings using the controller or camera menu.

**For details of the required personal computer environment, refer to page 9.**

### <NOTE>

- Some functions on the web setting screen can be used only from Windows Internet Explorer 11. Functions which can be used by Windows Internet Explorer 11 only are indicated using the **Windows I.E.11** mark.
- The "Network Camera View 4S" plug-in viewer software must have already been installed in order to display the unit's IP videos using Windows Internet Explorer 11. (This is not required for a personal computer which is running OS X (Mac).) For further details, refer to "Installing the plug-in viewer software" (→ page 28).

## Displaying the web screen using a personal computer

The procedure is explained here using Windows screens (Internet Explorer), but it is the same when using the Mac (Safari)\*2 screens. \*2 There may be differences in some parts of the screen displays.

### 1. Start the web browser of the personal computer.

Use one of the web browsers below depending on the operating system installed in the personal computer.

Operating system installed	Web browser
Windows	Windows 7 64/32-bit/Internet Explorer 11 Windows 10/Internet Explorer 11 Windows 10/Microsoft Edge Windows 10/Google Chrome
OS X (Mac)	OS X v10.11/Safari 9 macOS v10.12/Safari 10 macOS v10.13/Safari 11 macOS v10.13/Google Chrome

### 2. Enter the IP address you configured on the Easy IP Setup Software in the address bar of the web browser.

#### IPv4 address entry example:

http://URL registered with IPv4 address  
http://192.168.0.10/

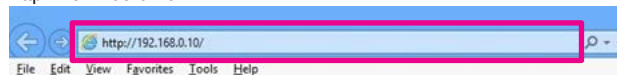

#### IPv6 address entry example:

http://[URL registered with IPv6 address]  
http://[2001:db8::10]/

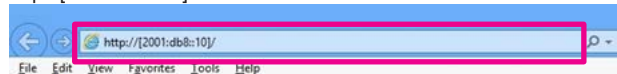

### <NOTE>

- If the HTTP port number has been changed from "80", enter "http://<camera IP address>:<port number>" in the address bar. Example: When the port number is set to 8080: http://192.168.0.11:8080
- If the unit is located on the local network, configure proxy server settings on the web browser ([Tool] - [Internet Options] in the menu bar) so that a proxy server is not used for the local address.
- For details on when [HTTPS] - [Connection] (→ page 115) is set to [HTTPS] in the [Advanced] tab of the Network screen, see "Accessing the Camera by HTTPS" (→ page 119).



### 3. Set the initial account.

In the initial state, the initial account setting screen is displayed when the web screen is displayed.

Set a user name and password.

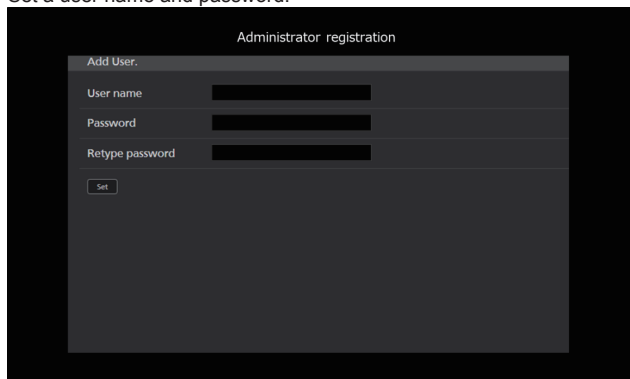

#### <NOTE>

- Do not set character strings that can be easily guessed by third parties.
- Change the password at regular intervals.
- The password must use at least 3 of the following 4 character types and be 8 characters or longer.
  - Alphabet capitals
  - Alphabet lowercase
  - Numerals
  - Special characters (! # \$ % ' ( ) + , - . / = ? @ [ ] ^ \_ ' { } ~)
- When a password is set that does not adhere to the above policy, take responsibility for use of the device with due consideration for the security risks in the installation environment, etc.
- A warning is displayed if the set password goes against the recommended setting policy.

When changing the password, log into the web screen, then change the password in the user authentication setting screen.

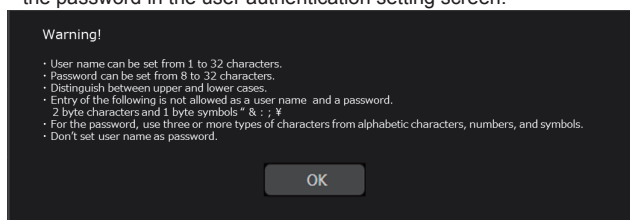

### 4. Completing registration of the initial account

After completing registration of the initial account, the following registration completed screen is displayed.

The live screen [Live] is automatically displayed after about 10 seconds elapse after the completed screen is displayed.

If the live screen [Live] is not displayed after 10 seconds elapse, manually move to the live screen [Live] by clicking the "please click here" link.

This completes the process of registering the initial account.

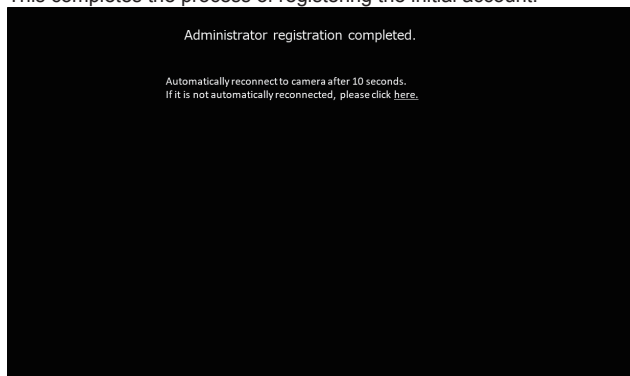

### 5. Press the [Enter] key.

The web screen appears.

The live screen [Live] (→ page 75) is displayed initially. You can switch to the web setup screen [SetUp] (→ page 81) when necessary. (→ page 74)

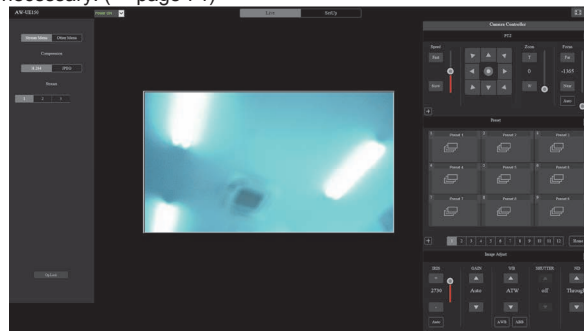

#### <NOTE>

- If the personal computer does not have the plug-in viewer software already installed, an installation confirmation message is displayed before the live screen [Live] is displayed. In a case like this, follow the on-screen instructions to install the software. [Windows I.E.11](#) For further details, refer to page 28.
- When [User auth.] (→ page 107) is set to [On], the user name and password input screen is displayed before the live screen [Live] appears.
- When an attempt is made to display multiple H.264 images on one personal computer, IP videos may not be displayed depending on the performance of the personal computer concerned. [Windows I.E.11](#)
- When an item which is underlined on the screen is clicked, a separate window opens, and an input example is displayed.
- Up to 14 users (consisting of users receiving H.264 images and users receiving JPEG images) can access the unit at the same time. However, the number of users that can access the unit may be less than 14 depending on the [Bandwidth control (bit rate)] and [Max bit rate (per client)] settings. A message indicating the access limit will appear if the number of users exceeds 14. When [Transmission type] is set to [Multicast port] for [H.264], the second and subsequent users receiving H.264 images will not be counted toward the total access count.
- When [H.264 transmission] (→ page 92) is set to [On], H.264 images are displayed. When it is set to [Off], JPEG images will be displayed. JPEG images can be displayed even when [H.264 transmission] is set to [On]. In such cases, however, the maximum frame rate of the JPEG images will be 5 fps. [Windows I.E.11](#)
- The JPEG image frame rate may be slower depending on the network environment, performance of your personal computer, subject of the video, and access volume.

#### <JPEG image frame rate>

When [H.264 transmission] is set to [On] [Windows I.E.11](#)

Up to 5 fps

When [H.264 transmission] is set to [Off] [Windows I.E.11](#)

Up to 30 fps

### Switching between the Live screen [Live] and Web setup screen [Setup]

When the live screen [Live] is displayed, click the [Setup] button



For details on the web setup screen [Setup], see "Web setup screen [Setup]" (→ page 81).



When the web setup screen [Setup] is displayed, click the [Live] button



For details on the live screen [Live], see "Live screen [Live]" (→ page 75).



#### <NOTE>

- During Standby mode, the [Setup] button is disabled, and you cannot switch to the web setup screen [Setup].
- If the unit is switched to Standby mode from another terminal while the web setup screen [Setup] is displayed, the display will switch to the live screen [Live] after a few seconds.

# Web screen operations

## Live screen [Live]

You can display images from the camera on a personal computer and perform camera operations, such as pan, tilt, zoom, and focus control. The items displayed on the screen will differ depending on whether the [H.264] or [JPEG] button is selected under [Compression].

When [H.264] is selected Windows I.E.11

The screenshot shows the live camera interface with H.264 compression selected. The interface is divided into several sections:

- OSD menu (1):** Stream Menu, Color Menu, OSD Menu (ON/OFF), and navigation buttons (4).
- Stream menu (2, 3, 7):** Compression (H.264/JPEG), Stream (1/2/3), and OnLock button.
- Camera Controller (13-16):** Speed (Fast/Slow), PTZ (Pan/Tilt/Zoom), Focus (Far/Near), and a Home button (16).
- Preset (14):** A grid of 12 preset buttons (Preset 1-12).
- Image Adjust (12, 20-23):** IRIS (2730), GAIN (Auto), WB (ATW), SHUTTER (off), and ND (Through).

(OSD menu)

(Stream menu)

When [JPEG] is selected

The screenshot shows the live camera interface with JPEG compression selected. The interface is similar to the H.264 version but with different menu options:

- OSD menu (1):** Stream Menu, Color Menu, OSD Menu (ON/OFF), and navigation buttons (4).
- Stream menu (2, 3, 7):** Compression (H.264/JPEG), Stream (1/2/3), and OnLock button.
- Camera Controller (13-16):** Speed (Fast/Slow), PTZ (Pan/Tilt/Zoom), Focus (Far/Near), and a Home button (16).
- Preset (14):** A grid of 12 preset buttons (Preset 1-12).
- Image Adjust (12, 20-23):** IRIS (2730), GAIN (Auto), WB (ATW), SHUTTER (off), and ND (Through).

(OSD menu)

(Stream menu)



### 1. Menu switching [Stream Menu]/[Other Menu]

Switch between menu displays.

Clicking [Other Menu] when the Stream menu is displayed displays the Other menu.

Clicking [Stream Menu] when the Other menu is displayed displays the Stream menu.

### 2. Compression button [Compression]

 [H264]	When selected, the text on the button turns green, and H.264 images are displayed. <a href="#">Windows I.E.11</a> The [H.264] button is enabled when the [H.264 transmission] setting of [H.264(1)] to [H.264(4)] on the Video over IP is [On]. (→ page 92)
 [JPEG]	When selected, the text on the button turns green, and JPEG images are displayed.

**<NOTE>**





- In the following cases, the selection status of the [Compression] buttons will return to the setting configured in the [Video over IP] tab - [Initial display setting] - [Stream]. [Windows I.E.11](#)
  - When returning from another screen
  - When the screen is updated

### 3. Stream buttons [Stream]

**When H.264 is selected**

These buttons appear only when H.264 images are displayed.

[Windows I.E.11](#)

 [1]	When selected, the button turns gray, and the images in the main area appear according to the settings configured for [H.264(1)]. (→ page 92)
 [2]	When selected, the button turns gray, and the images in the main area appear according to the settings configured for [H.264(2)]. (→ page 92)
 [3]	When selected, the button turns gray, and the images in the main area appear according to the settings configured for [H.264(3)]. (→ page 92)
 [4]	When selected, the button turns gray, and the images in the main area appear according to the settings configured for [H.264(4)]. (→ page 92)



**<NOTE>**

- In the following cases, the selection status of the [Stream] buttons will return to the setting configured in the [Video over IP] tab - [Initial display setting] - [Stream].
  - When returning from another screen
  - When the screen is updated
- If the H.264 image resolution is set to [1920x1080] or [1280x720], the image may be compressed depending on the size of the web browser window.

**When JPEG is selected**

**Image Capture Size buttons [Image Capture Size]**



These buttons appear only when JPEG images are displayed.

 [1]	When selected, the button turns gray, and the images in the main area appear according to the settings configured for [JPEG(1)]. (→ page 92)
 [2]	When selected, the button turns gray, and the images in the main area appear according to the settings configured for [JPEG(2)]. (→ page 92)
 [3]	When selected, the button turns gray, and the images in the main area appear according to the settings configured for [JPEG(3)]. (→ page 92)

**<NOTE>**

- The resolution selected with [JPEG(1)], [JPEG(2)], and [JPEG(3)] under [JPEG] in the [Video over IP] tab will be used.
- If the resolution is set to [1920x1080] or [1280x720], the image may be compressed depending on the size of the web browser window.
- In the following cases, the selection status of the [Image Capture Size] buttons will return to the setting configured in the [Video over IP] tab - [Initial display setting] - [Stream].
  - When returning from another screen
  - When the screen is updated

### 4. OSD Menu Operation [OSD Menu]

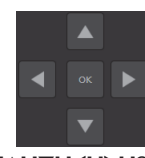
 [On] [Off]	Use this to select whether the camera's on-screen displays are to be shown.
 [Cancel]	It cancels the selection of the setting which is being changed. It restores the pre-change setting.
 [▲] [▼] [◀] [▶] [OK]	Use these to perform the menu operations. The items are selected using the [▲][▼][◀][▶] buttons. If a selected item has a sub menu, this sub menu is displayed by pressing the [OK] button. When the cursor is moved to any item on the bottom-level setting screen and the [OK] button is pressed, the setting of the selected item starts flashing. A setting for a regular menu item is reflected immediately if it is changed while it is still flashing. However, there are a number of menu items (Scene, Format and Initialize) whose setting is reflected only after the [OK] button has been pressed, causing the setting to stop flashing and the new setting to be entered.

### 5. Color bar button [Color bar]

 [On] [Off]	Switch the color bar signal displayed or hide.
---	--

### 6. Power ON button [Power ON]/Standby button [Standby]

<div style="border: 1px solid black; padding: 2px; width: fit-content;"> <span style="background-color: #ccc; padding: 2px;">Power ON</span> </div> <div style="border: 1px solid black; padding: 2px; width: fit-content;"> <span>[Power ON]</span> </div>	Turn the unit on.
<div style="border: 1px solid black; padding: 2px; width: fit-content;"> <span style="background-color: #ccc; padding: 2px;">Standby</span> </div> <div style="border: 1px solid black; padding: 2px; width: fit-content;"> <span>[Standby]</span> </div>	Set the unit to Standby mode.

In the Standby mode, all the buttons on the live screen [Live] except for the [Power ON] button, [Standby] button and [Op.Lock] button are disabled.

#### <NOTE>

- If [Power ON] or [Standby] is selected too quickly, the status selected and the display shown may not correspond. In a case like this, follow the steps below to restore the correct status display:

#### For Windows:

Press the [F5] key on the keyboard of the personal computer.

#### For Mac:

Press the [Command] + [R] keys on the keyboard of the personal computer.

#### • When operation is transferred to the Standby mode:

The current zoom, focus and iris positions are stored in the memory (Power ON preset).

#### • When operation is transferred to the Power ON mode:

The zoom, focus and iris are adjusted to the positions which were stored in the memory (Power ON preset) when operation was transferred to the Standby mode.

### 7. Operation lock button [Op.Lock]

<div style="border: 1px solid black; padding: 2px; width: fit-content;"> <span style="background-color: #ccc; padding: 2px;">Op.Lock</span> </div> <div style="border: 1px solid black; padding: 2px; width: fit-content;"> <span>[Op.Lock]</span> </div>	<p>This locks operations such as pan/tilt, zoom, focus, iris, gain, white balance, shutter, ND filter, and preset in the live screen [Live]. Furthermore, operation of the Other menu is locked, thus preventing operation errors.</p>
--	--

### 8. Main area (IP video display area)



The IP video of the connected camera will be displayed.

When the tally lamp is on, a red line is displayed at the top of the images.

When the tally lamp is off, the display area will return to normal.

Operating the mouse wheel inside the display area allows you to use the plug-in viewer software's digital zoom. [Windows I.E.11](#)



#### <NOTE>

- When the shooting scenes vary significantly, restrictions imposed by the graphics processing (GDI) of the operating system installed may give rise to a phenomenon called "screen tearing" (where parts of the picture are not displayed in synchronization) although this will depend on the personal computer used.
- On Windows Internet Explorer 11, if [H.264 transmission] (→ page 92) is set to [On], H.264 images and JPEG images can be displayed. When it is set to [Off], only JPEG images will appear.
- On a personal computer running OS X (Mac), regardless of the [H.264 transmission] settings, only JPEG images will appear. (H.264 images will not appear.)
- When [H.264 transmission] is set to [On], the frame rate for JPEG images may drop, regardless of whether H.264 images are being transmitted.
- The speed at which the JPEG images are refreshed may be reduced depending on the network environment, performance of the personal computer used, subjects and number of access users.
- Up to 14 users (consisting of users receiving H.264 images and users receiving JPEG images) can access the unit at the same time. (The maximum number of Android terminals which can be connected to the unit at the same time is one.) However, depending on the settings for the [Bandwidth control (bit rate)] and [Max bit rate (per client)], the number of users who can access the unit may be limited to less than 14.
- If the maximum number of users who can access the unit has exceeded the upper limit, a message advising that the unit is being accessed by more users than the maximum number allowed is displayed at the bottom part of the live screen [Live].
- When [Disable] is selected for [Tally] (→ page 59, page 89), the camera's tally lamp will not light even when the tally signal is input. However, the area frame of the main area (IP video display area) will turn red.

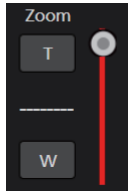
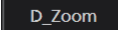
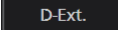
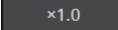
9.Zoom [Zoom]

	[T]: Use this to adjust the zoom (magnification) in the "Tele" direction. [W]: Use this to adjust the zoom (magnification) in the "Wide" direction.
[T] [W]	
 [D_Zoom]	Use this to enable or disable the digital zoom.
 [D-Ext.]	Use this to enable or disable the digital extender.
 [x1.0]	Use this to adjust the zoom (magnification) to 1.0x.

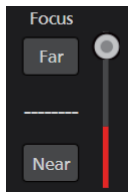

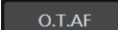
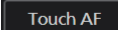
10.Focus [Focus]

	[Far]: Use this to adjust the focus in the "Far" direction. It does not work during automatic adjustments. [Near]: Use this to adjust the focus in the "Near" direction. It does not work during automatic adjustments.
[Far] [Near]	
 [Auto]	Use this to switch between auto and manual focusing. When Auto is selected, the focus is adjusted automatically.
 [O.T.AF]	When this is pressed while the focus is being adjusted manually, the focus will be temporarily adjusted automatically. It does not work during automatic adjustments.
 [Touch AF]	Focus is automatically adjusted in the area touched.

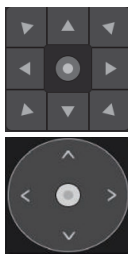
11.Control pad and its buttons

	To adjust the image in the horizontal or vertical direction (panning or tilting), left-click the pad and the buttons. It is possible to operate with the central grid pattern in the dragged state, with the speed of the pan/tilt increasing as it approaches the outside of the pad.
---	---





12.Brightness [IRIS]

	[+]: Operates in stages in the direction of iris opening. It does not work during automatic adjustments. [-]: Operates in stages in the direction of iris closing. It does not work during automatic adjustments.
[+] [-]	
 [Auto]	Use this to switch the iris adjustment between auto and manual. When Auto is selected, the picture brightness is adjusted automatically.

13.Speed [Speed]

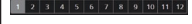
	Use this to select the speed at which the pan, tilt, zoom, focus, and brightness operations are to be performed.
[Fast] [Slow]	

14.Preset [Preset]

	When a preset thumbnail is clicked, the camera moves to face towards a preset position that was registered beforehand. You can select Home and Preset1 to Preset100.
 [1] - [12]	Switches the page of the displayed preset thumbnails.
 [Home]	Move to home position.
 [SET]	Registers the current state to the selected preset position.
 [DELETE]	Deletes the selected preset position settings.

15.Scene [Scene]

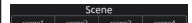
 [Scene]	Click scene1-scene4 to switch the shooting mode.
---	--

16.Full-screen display button

	Display the image in full-screen mode. To return to the live screen [Live], press the [Esc] key on the personal computer while the image is displayed in full-screen mode. The aspect ratio of the displayed image will be adjusted according to the monitor size.
---	--

17.Snapshot button

	Capture a snapshot (single still image), and display it in a separate window. Selecting [Save] underneath the image allows you to save the image to a personal computer.
---	--

<NOTE>

- The following settings may be necessary.
  - In the Internet Explorer menu bar, click [Tools] - [Internet Options] - [Security] tab, select [Trusted Sites], and then click [Sites]. Register the camera's address under [Websites] in the window that appears.
  - Depending on the network environment, for example, if snapshot capture takes longer than a certain amount of time, the image may not appear.
  - If [JPEG transmission(1)] - [JPEG transmission(3)] are all set to [Off], the image captured with the snapshot button will be black.

## Web screen operations (continued)



### 18.Connected device indication

Displays "4K Integrated Camera AW-UE150".

### 19.Camera title display area

The name for the unit configured in the Basic screen [Basic] (→ page 84) appears.





### 20.Gain [GAIN]

	Increase the gain of the images.
	Decrease the gain of the images.



#### <NOTE>

- The current gain value is displayed in the middle of the button.



### 21.Balance adjustment [WB]

	Increase the color temperature. This is only enabled when [White Balance Mode] is set to [VAR].
	Decrease the color temperature. This is only enabled when [White Balance Mode] is set to [VAR].
	Automatic white balance (AWB) is executed and the white balance is reset.
	Automatic black balance (ABB) is executed and the black balance is reset.

### 22.Shutter [SHUTTER]

	Switch the shutter mode in the order [Off], [Step], [Syncro], [ELC].
	Switch the shutter mode in the order [ELC], [Syncro], [Step], [Off].

### 23.ND filter [ND]

	Switch the transmittance of the ND filter in the order [Through], [1/4 ND], [1/16 ND], [1/64 ND].
	Switch the transmittance of the ND filter in the order [1/64 ND], [1/16 ND], [1/4 ND], [Through].

#### <NOTE>

- ND filter switching is not possible in night mode.

### 24.RTMP

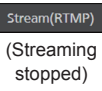
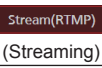
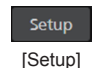
	Streaming transmission starts to the RTMP server that was pre-registered. The button turns red during transmission, and transmission stops when the button is clicked again.
	
	Register the information for the RTMP server to be transmitted to. The setting screen pops up when the [Setup] button is pressed.

#### [RTMP transmission server information registration screen]

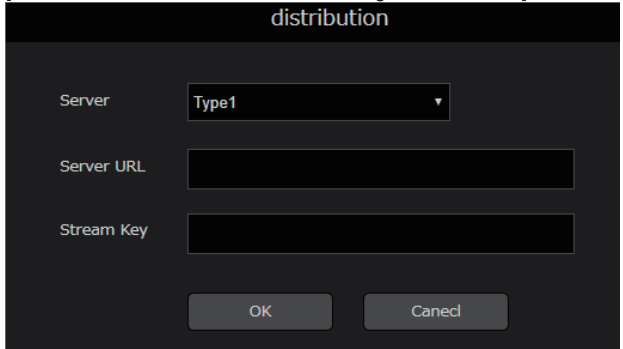

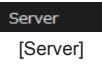
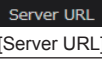
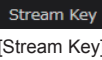
	Select the method for registering the information for the RTMP transmission server. <b>Type1:</b> Specify to individually set the server URL and RTMP stream key in [Server URL] and [Stream Key]. <b>Type2:</b> Specify to set the server URL and RTMP stream key as a set in [Server URL].
	Set the URL for the RTMP server to be transmitted to.
	The stream key obtained from the RTMP server is set during streaming only when the service is set to [Type1].

#### <NOTE>

- Switch to the appropriate method of registering RTMP transmission server information suited to the setting information notified from the RTMP transmission server you are using.
- The Stream Key setting field is displayed only when [Type1] is set.

# Web screen configurations

## Logging into the Web screen

### 1. Access AW-UE150 from a web browser. (→ page 74)

The login screen appears.

If user authentication is set to off, you need to enter account information for a user with admin privileges when displaying the [SetUp] screen.



### 2. Enter the user name and password.

Enter the user name and password that has already been registered.

#### <NOTE>

- It is recommended that the password be changed at regular intervals.
- During Standby mode, the [SetUp] button is disabled, and you cannot switch to the web setup screen [SetUp].



### Web setup screen [SetUp]

The settings for the unit are selected on this screen.

#### <NOTE>

- The setting menu operations can be performed only by users whose access level is "1.Administrator".  
For the procedure used to set the access level, refer to page 108.

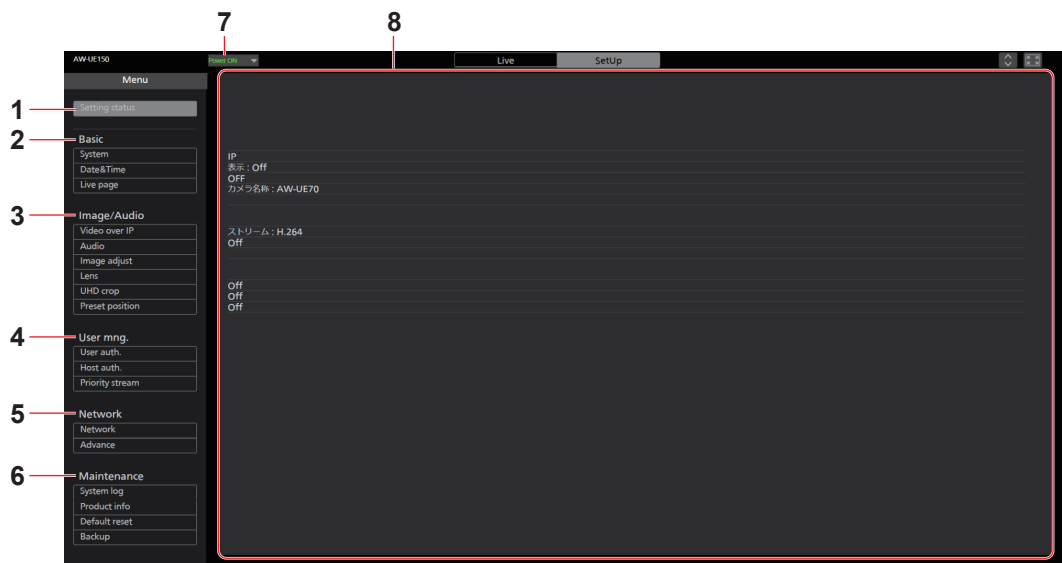

#### 1. Setting status [Setting status]

The setting status screen [Setting status] is displayed when the button is clicked.

→ "Setting status screen [Setting Status]" (→ page 83)

#### 2. Basic settings [Basic]

##### System button [System]

The system screen [System] is displayed when the button is clicked.

→ "System screen [System]" (→ page 86)

##### Date&Time button [Date&Time]

The Date & time screen [Date&Time] is displayed when the button is clicked.

→ "Date & time screen [Date&Time]" (→ page xx)

##### Live page button [Live page]

The live page screen [Live page] is displayed when the button is clicked.

→ "Live page screen [Live page]" (→ page xx)

#### 3. Image/Audio [Image/Audio]

##### IP video settings button [Video over IP]

The IP video settings screen [Video over IP] is displayed when the button is clicked.

→ "IP video settings screen [Video over IP]" (→ page 90)

##### Audio button [Audio]

The audio setting screen [Audio] is displayed when the button is clicked.

→ "Audio screen [Audio]" (→ page 96)

##### Image adjust button [Image adjust]

The image adjust screen [Image adjust] is displayed when the button is clicked.

→ "Image adjust screen [Image adjust]" (→ page 97)

##### Lens button [Lens]

The Lens setting screen [Lens] is displayed when the button is clicked.

→ "Lens setting screen [Lens]" (→ page xx)

##### UHD crop button [UHD crop]

The UHD crop setting screen [UHD crop] is displayed when the button is clicked.

→ "UHD crop setting screen [UHD crop]" (→ page xx)

##### Preset position button [Preset position]

The preset position screen [Preset position] is displayed when the button is clicked.

→ "Preset position screen [Preset position]" (→ page 104)

### 4. User management settings [User mng.]

#### User authentication button [User auth.]

The user authentication screen [User auth.] is displayed when the button is clicked.

→ “User authentication screen [User auth.]” (→ page 107)

#### Host authentication button [Host auth.]

The host authentication screen [Host auth.] is displayed when the button is clicked.

→ “Host authentication screen [Host auth.]” (→ page 108)

#### Priority stream button [Priority stream]

The priority stream screen [Priority stream] is displayed when the button is clicked.

→ “Priority stream screen [Priority stream]” (→ page 109)

### 5. Network settings [Network]

#### Network setup button [Network]

The network setup screen [Network] is displayed when the button is clicked.

→ “Network setup screen [Network]” (→ page 110)

#### Advanced network setting button [Advanced]

The advanced network setting screen [Advanced] is displayed when the button is clicked.

→ “Advanced network setting screen [Advanced]” (→ page 113)

### 6. Maintenance [Maintenance]

#### System log button [System log]

The system log screen [System log] is displayed when the button is clicked.

→ “System log screen [System log]” (→ page 122)

#### Product information button [Product info]

The product information screen [Product info.] is displayed when the button is clicked.

→ “Product information screen [Product info.]” (→ page 122)

#### Reset settings button [Default reset]

The reset settings screen [Default reset] is displayed when the button is clicked.

→ “Reset settings screen [Default reset]” (→ page 123)

#### Back up button [Backup]

The back up screen [Back up] is displayed when the button is clicked.

→ “Back up screen [Back up]” (→ page 124)

### 7. Power ON button [Power ON]/Standby button [Standby]

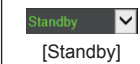
 Power ON [Power ON]	Turn the unit on.
 Standby [Standby]	Set the unit to Standby mode.

When you enter Standby mode, the display will automatically switch to Live mode. In addition, the [SetUp] button in the live screen [Live] will be disabled, and you cannot operate the web setup screen [SetUp].

### 8. Main area

The menu screen is displayed.

Setting status screen [Setting Status]

IP  
表示 : Off  
Off  
カメラ名称 : AW-UE70

ストリーム : H.264  
Off

Off  
Off  
Off

### Basic screen [Basic]

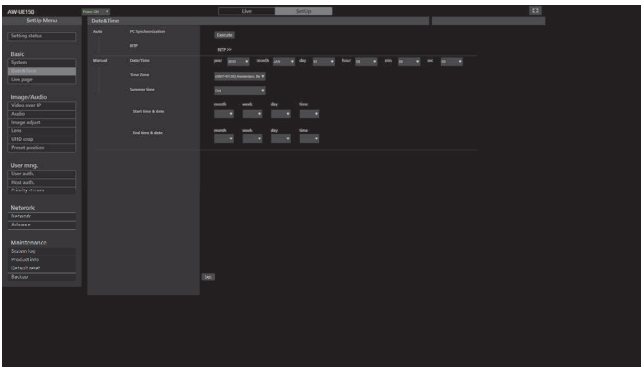
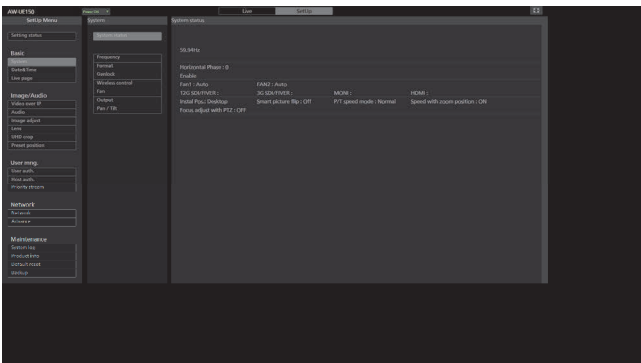

### System status

Displays the current system setting status.

### Frequency

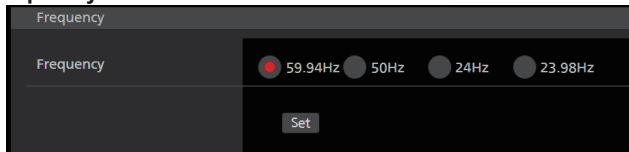

This item is selected to switch the frame frequency.

**Setting value:** 59.94Hz/50Hz

• When the frequency is switched, [Format] is set as follows.

59.94Hz		50Hz
1080/59.94p	↔	1080/50p
1080/29.97p	↔	1080/25p
1080/23.98p	→	1080/25p
1080/59.94i	↔	1080/50i
1080/29.97PsF	↔	1080/25PsF
1080/23.98PsF	→	1080/25PsF
720/59.94p	↔	720/50p
480/59.94p(i)	↔	576/50p(i)

**Factory settings:** 59.94Hz (AW-UE150WP/AW-UE150KP)  
50Hz (AW-UE150WE/AW-UE150KE)

### Format

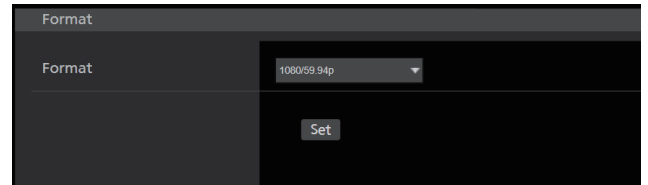

The video format is changed on this screen.

For [480/59.94p(i)] and [576/50p(i)], P signals are output for HDMI, while I signals are output for SDI and video outputs.

**Setting value:**

**For 59.94Hz:**

1080/59.94p, 1080/29.97p, 1080/23.98p, 1080/59.94i,  
1080/29.97PsF, 1080/23.98PsF, 720/59.94p, 480/59.94p(i)

**For 50Hz:**

1080/50p, 1080/25p, 1080/50i, 180/25PsF, 720/50p, 576/50p(i)

**Factory settings:** 1080/59.94i (AW-UE150WP/AW-UE150KP)  
1080/50i (AW-UE150WE/AW-UE150KE)

<NOTE>

• When you switch from an HD format to an SD format or vice versa, the unit automatically restarts after the Format Set screen appears.

### Genlock

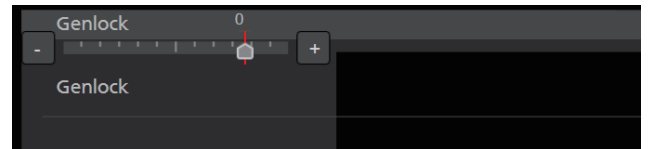

This item's setting is reflected immediately.

### Wireless Control

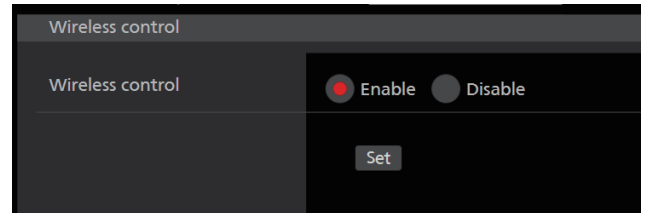

Sets the wireless remote control to enable or disable.

**Setting value:** Enable/Disable

## Web screen configurations (continued)

### Fan

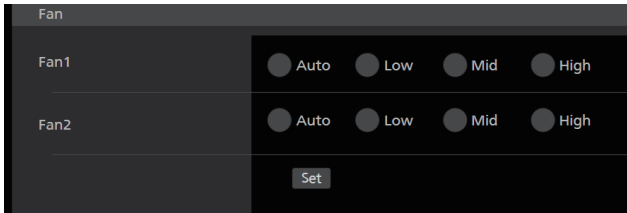

Set the cooling fan operation.

#### Fan1

Set the operation of the cooling fan near the lens.

##### Setting value:

Auto	Enable automatic control of the cooling fan.
Low	Operate the cooling fan at low speed.
Mid	Operate the cooling fan at medium speed.
High	Operate the cooling fan at high speed.

Factory settings: xxxxxxxx

#### Fan2

Set the operation of the cooling fan near the pan-tilt head.

##### Setting value:

Auto	Enable automatic control of the cooling fan.
Low	Operate the cooling fan at low speed.
Mid	Operate the cooling fan at medium speed.
High	Operate the cooling fan at high speed.

Factory settings: xxxxxxxx

#### <NOTE>

- Even if this is set to [Low], [Mid], or [High], the cooling fan may be forcibly stopped when the temperature is low.
- Even if this is set to [Low] or [Mid], the cooling fan may be forcibly operated at [High] when the temperature is high.

### Install position

[Desktop] or [Hanging] is selected here as the method used to install the unit.

##### Setting value:

Desktop	Stand-alone installation
Hanging	Suspended installation

Factory settings: Desktop

- When [Hanging] has been selected, the top, bottom, left and right of the images will be reversed, and up/down/left/right control for panning and tilting will also be reversed.

### Smart picture flip

When this is set to [Auto] and the tilt becomes the angle set for [Flip detect angle], the image will be flipped in the vertical direction automatically.

##### Setting value:

Off	Does not flip the image vertically.
Auto	When the tilt becomes the angle set for [Flip detect angle], the image will be flipped in the vertical direction automatically.

Factory settings: Off

### Speed with zoom position

“Off” or “On” is set here for the function used to adjust the pan-tilt adjustment speed in conjunction with the zoom magnification.

When [On] is set, the panning and tilting operations will become slower in the zoom status.

This function has no effect during preset operations.

Setting value: Off/On

Factory settings: On

### Focus adjust with PTZ

“Off” or “On” is set here for the function which compensates for out-of-focusing when it occurs during panning, tilting or zooming operations. When [Off] is set, adjust the focus as required after zooming or set the focus to the auto mode.

This item can be selected only when [Manual] has been selected as the [Focus Mode] setting.

##### Setting value:

Off	Out-of-focusing is not compensated.
On	Out-of-focusing is compensated.

Factory settings: Off

### P/T Speed Mode

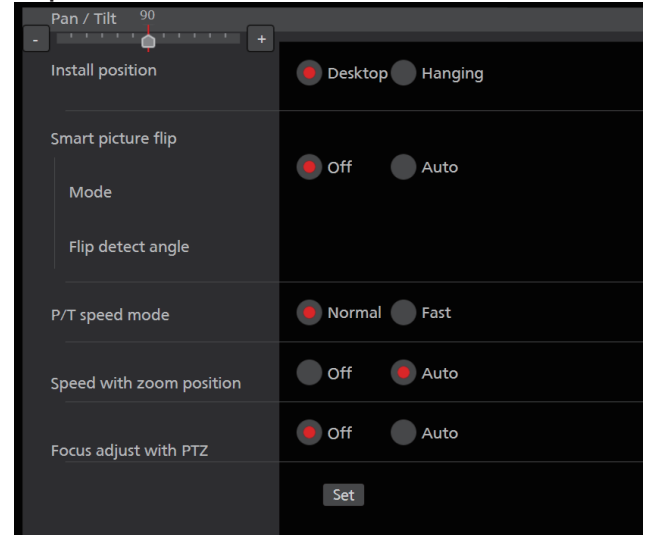

Set the speed of pan/tilt operation.

Normal	Pan/tilt operates at normal speed (maximum 60° per second).
Fast	Pan/tilt operates at fast speed (maximum 200° per second).

Factory settings: Normal

#### <NOTE>

- The pan/tilt operation noise may increase when [Fast] is selected.
- Even when [Fast] is selected, the pan/tilt speed during preset playback will be the same speed as when [Normal] is selected.

### Camera title

Input the name of the camera here.

When the [Set] button is clicked, the input name appears in the camera title display area.

- The factory default setting is the model number of the unit.
- You can enter between 0 to 20 characters.
- The following characters can be displayed.

Numeric characters	0123456789
Alphabetical characters (upper and lower cases)	ABCDEFGHIJKLMNOPQRSTUVWXYZ abcdefghijklmnopqrstuvwxyz
Symbols	!#\$%^()*+,-./:;<=>?@[^_`{ }~

### Time & date - Date/time

Enters the current date and time.

**Setting range:** Jan/01/2013 00:00:00 to Dec/31/2035 23:59:59

<NOTE>

- If you require a more accurate date and time for your system's operations, use an NTP server.

### Time & date - NTP

When [NTP >>] is clicked, you will be moved to the [NTP] setting page in the [Advanced] tab of the Network setup screen [Network]. (→ page 113)

### Time & date - Time zone

Selects the time zone according to the region where the camera is being used.

**Factory settings:**

(GMT) Greenwich Mean Time: Dublin, Edinburgh, Lisbon, London

### Time & date - Summer time (daylight saving)

Sets whether to use summer time.

Sets summer time based on the region.

**Setting value:**

In	Sets the time to summer time.
Out	Cancels summer time.
Auto	Switches to summer time according to the start/end time and date settings (time, day, week, month).

**Factory settings:** Out

### Time & date - Start time & date

### Time & date - End time & date

Sets the summer time start/end time and date by time, day, week and month when [Auto] is selected in the [Summer time (daylight saving)] setting.

### Automatic installation of viewer software

One of the following settings is selected for the automatic installation of the plug-in viewer software.

**Setting value:**

On	The plug-in viewer software is automatically installed.
Off	The plug-in viewer software is not automatically installed.

**Factory settings:** On

### Smoother live video display on the browser (buffering)

Configure settings for displaying images from the unit on the plug-in viewer software.

**Setting value:**

On	Temporarily store images from the unit onto the personal computer for smoother display.
Off	Do not temporarily store images from the unit onto the personal computer, and display them in real time.

**Factory settings:** On

<NOTE>

- Images and audio cannot be viewed or heard on personal computers on which the "Network Camera View 4S" plug-in viewer software is not installed.
- You can view the number of times the plug-in software was installed under the [Product info.] tab in the [Maintenance] menu of the unit's Web setting screen [Setup].

## System screen [System]

This menu has items that relate to the genlock phase adjustment and camera's output image settings.

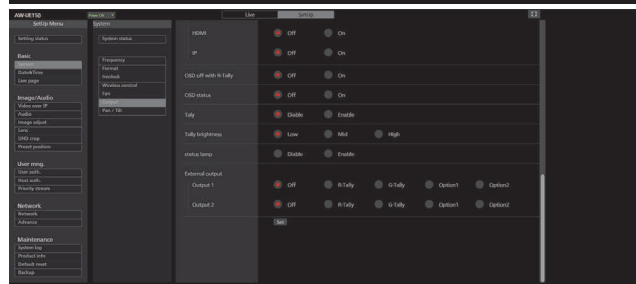
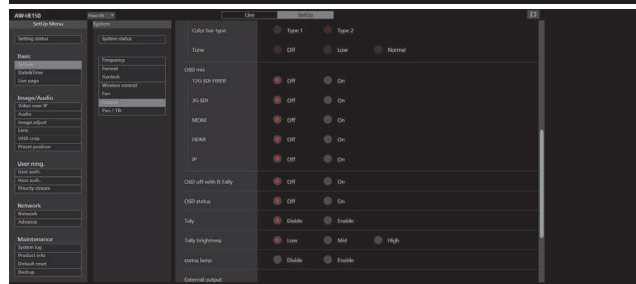
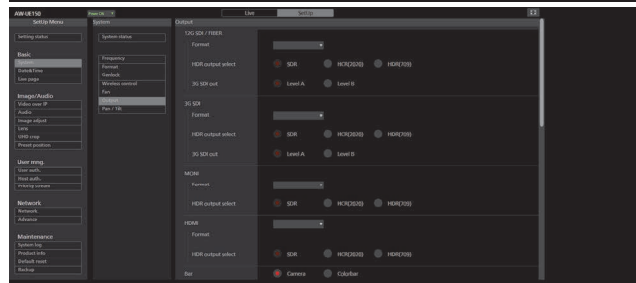
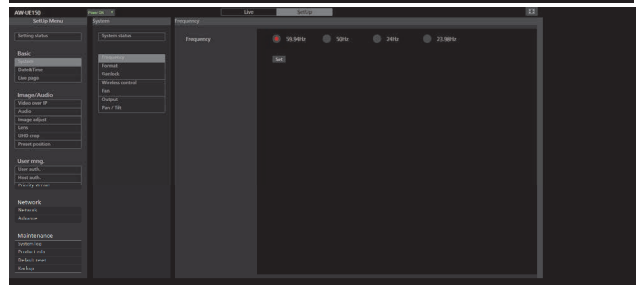
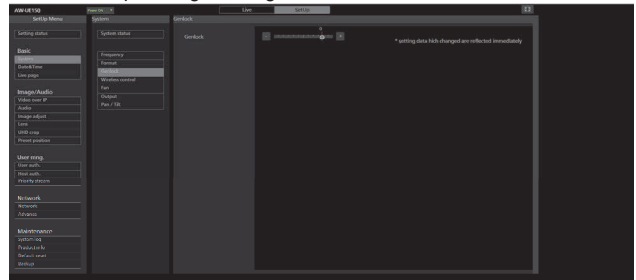

● **Genlock**

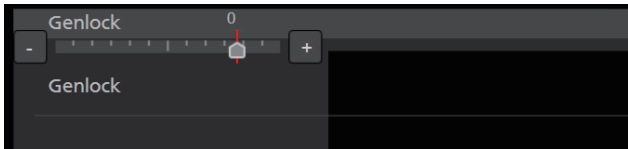

This item's setting is reflected immediately.

**Horizontal Phase**

This is used to adjust the horizontal phase during genlock.

**Setting range:** -206 to +49

**Factory settings:** 0

<NOTE>

- The horizontal phases of the HD and SD signals cannot be adjusted separately.  
Neither is it possible to adjust the chroma phase of the VIDEO OUT signals. The free run setting is used.

● **Output 1/3**

This item's setting is reflected when the [Set] button is pressed.

**Format**

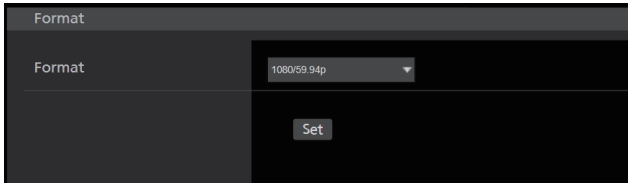

The video format is changed on this screen.

For [480/59.94p(i)] and [576/50p(i)], P signals are output for HDMI, while I signals are output for SDI and video outputs.

**Setting value:**

**For 59.94Hz:**

1080/59.94p, 1080/29.97p, 1080/23.98p, 1080/59.94i, 1080/29.97PsF, 1080/23.98PsF, 720/59.94p, 480/59.94p(i)

**For 50Hz:**

1080/50p, 1080/25p, 1080/50i, 180/25PsF, 720/50p, 576/50p(i)

**Factory settings:** 1080/59.94i (AW-UE150WP/AW-UE150KP)  
1080/50i (AW-UE150WE/AW-UE150KE)

<NOTE>

- When you switch from an HD format to an SD format or vice versa, the unit automatically restarts after the Format Set screen appears.

● **Output 2/3**

This item's setting is reflected when the [Set] button is pressed.

**Frequency**

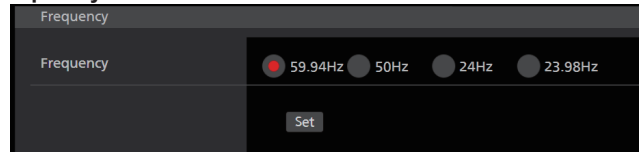

This item is selected to switch the frame frequency.

**Setting value:** 59.94Hz/50Hz

- When the frequency is switched, [Format] is set as follows.

59.94Hz		50Hz
1080/59.94p	↔	1080/50p
1080/29.97p	↔	1080/25p
1080/23.98p	→	1080/25p
1080/59.94i	↔	1080/50i
1080/29.97PsF	↔	1080/25PsF
1080/23.98PsF	→	1080/25PsF
720/59.94p	↔	720/50p
480/59.94p(i)	↔	576/50p(i)

**Factory settings:** 59.94Hz (AW-UE150WP/AW-UE150KP)  
50Hz (AW-UE150WE/AW-UE150KE)

● **Output 3/3**

This item's setting is reflected when the [Set] button is pressed.

**Down CONV. Mode**

The down-conversion mode is selected here.

**Setting value:**

Squeeze	Use this when the aspect ratio of the monitor is 16:9. When the 4:3 aspect ratio has been set for the monitor screen, the images are squeezed horizontally and extended vertically changing the view of the angle. 
SideCut	Use this when the aspect ratio of the monitor is 4:3. With the vertical height serving as the reference, the parts which extend beyond this at the two sides are cropped changing the view of the angle. 
LetterBox	Use this when the aspect ratio of the monitor is 4:3. With the horizontal width serving as the reference, black bands are added at the top and bottom changing the view of the angle. 

**Factory settings:** Squeeze

**Color Bars Setup**

This is only enabled when [Frequency] is set to [59.94Hz].

Select the color bar setup level (Off: 0.0IRE, On: 7.5IRE) for the VIDEO OUT signal.

**Setting value:**

Off	0.0IRE
On	7.5IRE

**Factory settings:** Off

## Web screen configurations (continued)

### ● Others

This item's setting is reflected when the [Set] button is pressed.

### Install Position

"Desktop" or "Hanging" is selected here as the method used to install the unit.

**Setting value:**

Desktop	Stand-alone installation
Hanging	Suspended installation

**Factory settings:** Desktop

- When [Hanging] has been selected, the top, bottom, left and right of the images will be reversed, and up/down/left/right control for panning and tilting will also be reversed.

### Smart picture flip

When this is set to [Auto] and the tilt becomes the angle set for [Flip detect angle], the image will be flipped in the vertical direction automatically.

**Setting value:**

Off	Does not flip the image vertically.
Auto	When the tilt becomes the angle set for [Flip detect angle], the image will be flipped in the vertical direction automatically.

**Factory settings:** Off

### Flip Detect Angle

Set the tilt angle at which the image will be flipped in the vertical direction automatically when [Smart Picture Flip] is set to [Auto].

**Setting range:** 60° to 120°

**Factory settings:** 90°

### Preset Speed Table

Set the preset speed table (Slow, Fast).

During preset playback, presets are performed at [Preset Speed] (1 to 30) values that are based on the table set here.

**Setting value:** Slow/Fast

**Factory settings:** Fast

### Preset Speed

Set the pan/tilt movement speed used when recalling camera orientation information registered to the preset memory (30 steps).

**Setting range:** 1 to 30

**Factory settings:** 20

- When you set large Preset Speed values, the image may sway when the movement stops.
- When [Preset Speed Table] is set to [Fast], [Preset Speed] values equivalent to the AW-HE120 will be applied.

### Preset Scope

Selected here are the setting items to be recalled when the contents of the preset memory are regenerated.

**Setting value:**

Mode A	Pan, Tilt, Zoom (including digital zoom), Focus, Iris, Gain, white balance adjustment value
Mode B	Pan, Tilt, Zoom (including digital zoom), Focus, Iris
Mode C	Pan, Tilt, Zoom (including digital zoom), Focus

**Factory settings:** Mode A

### Preset D-Extender

Turns the preset digital extender function off/on.

When set to [On], the digital extender function configuration will be recalled when regenerating the preset memory. When set to [Off], the digital extender function configuration will not be recalled when storing the preset memory.

**Setting value:** Off/On

**Factory settings:** Off

### Freeze During Preset

Turn the function for freezing images during preset playback off/on.

When this is set to [On], preset playback is performed with a still of the image immediately preceding the start of preset playback being output. The image freeze is released when preset playback is finished.

**Setting value:** Off/On

**Factory settings:** Off

### Speed with zoom position

"Off" or "On" is set here for the function used to adjust the pan-tilt adjustment speed in conjunction with the zoom magnification.

When [On] is set, the panning and tilting operations will become slower in the zoom status.

This function has no effect during preset operations.

**Setting value:** Off/On

**Factory settings:** On

### Focus Mode

Select auto or manual mode for the focus adjustment function.

**Setting value:**

Auto	Always adjust focus automatically.
Manual	Adjust focus manually.

**Factory settings:** Auto

**<NOTE>**

- [Focus Mode] cannot be set to [Auto] when [Frame Mix] is set to [18dB] or [24dB].

### Focus adjust with PTZ

"Off" or "On" is set here for the function which compensates for out-of-focusing when it occurs during panning, tilting or zooming operations. When [Off] is set, adjust the focus as required after zooming or set the focus to the auto mode.

This item can be selected only when [Manual] has been selected as the [Focus Mode] setting.

**Setting value:**

Off	Out-of-focusing is not compensated.
On	Out-of-focusing is compensated.

**Factory settings:** Off



### Digital Zoom

[Enable] or [Disable] is set here for the digital zoom function.

If zooming is performed toward the Tele end beyond the maximum position when [Enable] has been selected, the digital zoom can be operated continuously. Zooming will stop temporarily at the position where the optical zoom and digital zoom are switched so after it has stopped at this position, proceed with zooming again.

When the setting is changed to [Disable] while already in the digital zoom region, the zoom will automatically move to the maximum position of the optical zoom.

**Setting value:** Disable/Enable

**Factory settings:** Disable

<NOTE>

- The digital zoom is set to off when color bars are displayed during digital zooming.

### Max Digital Zoom

Set the maximum digital zoom magnification.

**Setting value:** x2/x3/x4/x5/x6/x7/x8/x9/x10

**Factory settings:** x10

### Digital Extender

Turn the digital extender function off/on.

When this is set to [On], the digital zoom will be fixed at 1.4x.

When [Digital Zoom] is set to [Enable], [Digital Extender] is disabled.

**Setting value:** Off/On

**Factory settings:** Off

### OIS

Enable or disable the optical image stabilization (OIS) function.

**Setting value:** Off/On

**Factory settings:** Off

<NOTE>

- The optical image stabilization (OIS) function's level of correction is reduced during pan/tilt operations.

### Tally

[Enable] or [Disable] is set here for the function which turns on or turns off the tally lamp using the tally control signal.

**Setting value:** Disable/Enable

**Factory settings:** Enable

### Tally Brightness

Adjust the brightness of the tally LED.

**Setting value:** Low/Mid/High

**Factory settings:** Low

<NOTE>

- When this is set to [Low], the LED brightness is equivalent to that of the AW-HE120.

### Status Lamp

Sets the status display lamp to [Disable] or [Enable].

When you want the status display lamp to stay off while this unit is in operation, set to [Disable].

**Setting value:** Disable/Enable

**Factory settings:** Enable

<NOTE>

- Even when set to [Disable], the status display lamp may light up when this unit is starting up, updating firmware, or trouble is occurring.

### OSD Mix

Select whether to turn off/on camera menu, status, and other displays for each output image.

**Setting value:** Off/On

**Factory settings:** On

### SDI Out

### HDMI Out

### Video Out

### IP

When this is set to [On], the camera menu, status, and other displays for corresponding output image are displayed.

**Setting value:**

Off	The camera menus and statuses are not displayed on the output pictures targeted by the setting items listed above.
On	The camera menus and statuses are displayed for the output pictures covered by the setting items listed above.

**Factory settings:** On

<NOTE>

- When this is set to off, the camera menu can be displayed for about 1 minute after the unit is turned on.

### OSD Off With Tally

On or off the function that turns off camera menu, status, and other displays when tally signals are received via commands or contacts.

When the tally signal releases, the camera menu display will return.

**Setting value:** Off/On

**Factory settings:** Off

### OSD Status

Turn the status display during AWB and ABB on/off.

**Setting value:** Off/On

**Factory settings:** Off

### Model Select

Set the protocol model for standard serial communication.

Do not select [Reserved1] to [Reserved7].

Appears when the service switch (SW4) at the bottom of the unit is set to ON (standard serial communication).

**Setting value:**

SEVIHD1/SBRC300/SBRCZ330/Reserved1 to Reserved7

**Factory settings:** SEVIHD1

**Image/audio screen [Image/Audio]**

**IP video settings screen [Video over IP]**

The JPEG image and H.264 image settings as well as the settings related to image quality are selected on this screen.

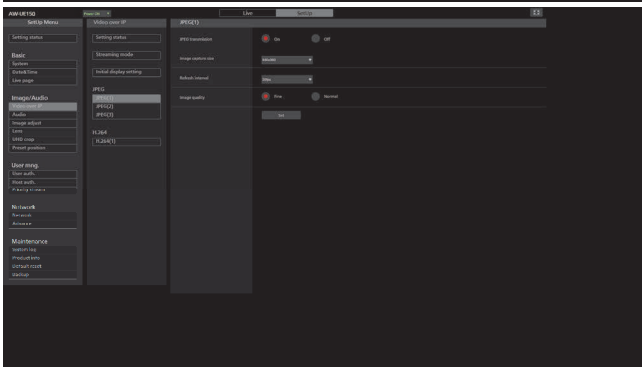
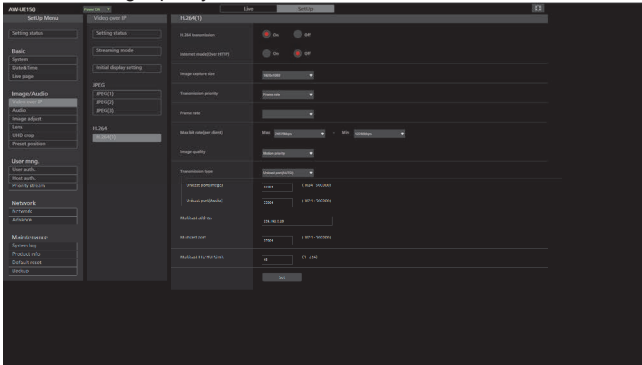

● **Initial display settings for “live” page**

Set initial display settings for the Live screen [Live].

**Stream**

Select the type of images to display in the Live screen [Live].

**Setting value:**

H.264(1) Windows I.E.11	Display videos (H.264(1)).
H.264(2) Windows I.E.11	Display videos (H.264(2)).
H.264(3) Windows I.E.11	Display videos (H.264(3)).
H.264(4) Windows I.E.11	Display videos (H.264(4)).
JPEG(1)	Display still images (JPEG(1)).
JPEG(2)	Display still images (JPEG(2)).
JPEG(3)	Display still images (JPEG(3)).

**Factory settings:** H264(1)



### Refresh interval (JPEG)

Select the frame rate for JPEG images.

**Setting value:**

**For 59.94Hz:**

1fps/2fps/3fps/5fps/6fps\*1/10fps\*1/15fps\*1/30fps\*1

**For 50Hz:**

1fps/2fps/5fps/10fps\*1/12.5fps\*1/25fps\*1

**Factory settings:** 5fps

\*1 When [H.264 transmission] is set to [On], the frame rate may be slower than the specified value in some cases.

**<NOTE>**

- The frame rate may be slower depending on the network environment, resolution, image quality, access volume, etc.
- If images are not transmitted at the specified frame rate, lowering the resolution or image quality may result in transmissions closer to the specified value.

### Image quality (JPEG)

When displaying JPEG images in the live screen [Live], set the quality of the first image that appears to [Quality1] or [Quality2].

**Setting value:**

Quality1	Image quality 1
Quality2	Image quality 2

**Factory settings:** Quality1

### ● Parameter Setting

#### Parameter

Set the unit's settings to factory default settings.

**Setting value:**

Original	Set the unit's settings to the AW-HE130's setting values.
NDI HX	Set the unit's settings to the AW-HN130's setting values.

**Factory settings:** NDI|HX

### ● JPEG

Sets the "image resolution", "Quality 1", "Quality 2" and so on for [JPEG(1)], [JPEG(2)] and [JPEG(3)]. For details on settings for H.264 images, see "H.264(1) • H.264(2) • H.264(3) • H.264(4)" (→ page 92).

**<NOTE>**

- Different resolutions must be selected for [JPEG(1)] to [JPEG(3)]. The same resolution cannot be selected for separate JPEG images.

### JPEG transmission

Sets whether to transmit the JPEG images to [On] or [Off].

**Setting value:**

On	JPEG images are transmitted.
Off	JPEG images are not transmitted.

**Factory settings:** On

**<NOTE>**

- When [JPEG(1)] is set to [Off], the image captured with the snapshot button will be black.
- When [JPEG(1)], [JPEG(2)] or [JPEG(3)] is set to [Off], the multi screen may not display. Set all to [On] to use the multi screen.

### Image capture size

Select from the following resolutions for the images to be displayed when displaying JPEG images.

**Setting value:**

1920x1080/1280x720/640x360/320x180/160x90

**Factory settings:**

JPEG(1): 1920x1080

JPEG(2): 640x360

JPEG(3): 320x180

### Image quality

Specify the JPEG image quality (2 types) for each resolution.

**Setting value:**

0 Super fine/1 Fine/2/3/4/5 Normal/6/7/8/9 Low

**Factory settings:**

Image quality 1: 5 Normal

Image quality 2: 8

### ● H.264(1) • H.264(2) • H.264(3) • H.264(4) Windows I.E.11

Specify the [Max bit rate (per client)], [Image capture size], [Image quality], and other settings for H.264 images.

For details on setting the JPEG images, see "JPEG" (→ page 92).

### H.264 transmission

Whether to transmit the H.264 images is set here using [On] or [Off].

**Setting value:**

On	H.264 images are transmitted.
Off	H.264 images are not transmitted.

**Factory settings:**

H.264(1), H.264(2): On

H.264(3), H.264(4): Off

**<NOTE>**

- When [On] has been selected as the [H.264 transmission] setting, both H.264 images and JPEG images can be displayed on the live screen [Live].
- When [On] has been selected as the [H.264 transmission] setting, the JPEG image refresh interval may become slower.

### Internet mode (over HTTP)

This setting is selected when transmitting H.264 images over the Internet.

H.264 images can be transmitted using the same broadband router settings as when transmitting JPEG images.

**Setting value:**

On	The H.264 images and audio are transmitted using the HTTP port. For details on setting the HTTP port number, refer to page 111.
Off	The H.264 images and audio are transmitted using the UDP port.

**Factory settings:** Off

**<NOTE>**

- When [On] is set, only [Unicast port (AUTO)] can be selected as the transmission type setting.
- When [On] is set, it takes a few seconds before the H.264 images are displayed.
- When this is set to [On], H.264 images may not appear depending on the number of users accessing the unit at the same time and whether audio data exists.
- When this is set to [On], access will be limited to IPv4.

## Web screen configurations (continued)

### Image capture size

Select the resolution for H.264 images.

Selectable options will vary depending on the selected resolution setting.

**Setting value:**

H264(1)	1920×1080 1280×720
H264(2)	1920×1080 1280×720 640×360 320×180 160×90
H264(3)	1280×720 640×360 320×180 160×90
H264(4)	1280×720 640×360 320×180 160×90

**Factory settings:**

H.264(1): 1920×1080

H.264(2): 640×360

### Transmission priority

Set the transmission mode for H.264 images.

**Setting value:**

Constant bit rate	Transmits H.264 images at the bit rate specified in [Max bit rate (per client)].
Frame rate	Transmit H.264 images at the frame rate specified in [Frame rate].
Best effort	Transmit H.264 images at a variable bit rate between the maximum and minimum specified in [Max bit rate (per client)], according to the network bandwidth.
Advanced VBR	Transmit H.264 images at the frame rate specified in [Frame rate]. Images will be transmitted so that the average transmission volume during the duration specified in [Control time period] will be the bit rate specified in [Max bit rate (per client)].

**Factory settings:** Frame rate

**<NOTE>**

- When [Transmission priority] is set to [Frame rate] or [Advanced VBR], the number of users that can connect may decrease.

### Frame rate

Set the frame rate for H.264 images.

**Setting value:**

**For 59.94Hz:**

5fps\*<sup>1</sup>/15fps\*<sup>1</sup>/30fps\*<sup>1</sup>/60fps\*<sup>1</sup>

**For 50Hz:**

5fps\*<sup>1</sup>/12.5fps\*<sup>1</sup>/25fps\*<sup>1</sup>/50fps\*<sup>1</sup>

**Factory settings:**

**For 59.94Hz:** 30fps

**For 50Hz:** 25fps

- \*<sup>1</sup> The [Frame rate] is limited by the [Max bit rate (per client)] setting. The actual frame rate may be lower than the specified value.

**<NOTE>**

- This setting is only enabled when [Transmission priority] is set to [Frame rate] or [Advanced VBR].
- [H.264(1)] is fixed at [60fps] (for 59.94Hz) and [50fps] (for 50Hz). [60fps] (for 59.94Hz) and [50fps] (for 50Hz) cannot be selected for [H.264(2)] to [H.264(4)].

### Burst tolerance level

Select how much more than the [Max bit rate (per client)] value to allow for the H.264 bit rate.

**Setting value:**

High/Middle/Low

**Factory settings:** Low

**<NOTE>**

- This setting is only enabled when [Transmission priority] is set to [Advanced VBR].

### Control time period

Select the duration for which the H.264 bit rate will be controlled.

Images will be transmitted so that the average transmission volume during the duration specified will be the bit rate specified in [Max bit rate (per client)].

**Setting value:**

1h	1 hour
6h	6 hours
24h	1 day (24 hours)
1 week	1 week

**Factory settings:** 24h

**<NOTE>**

- This setting is only enabled when [Transmission priority] is set to [Advanced VBR].

### Max bit rate (per client)

Specify the H.264 bit rate per client.

When [Transmission priority] is set to [Best effort], specify the maximum and minimum bit rate.

**Setting value:**

64kbps/128kbps\*<sup>2</sup>/256kbps\*<sup>2</sup>/384kbps\*<sup>2</sup>/512kbps\*<sup>2</sup>/768kbps\*<sup>2</sup>/  
1024kbps\*<sup>2</sup>/1536kbps\*<sup>2</sup>/2048kbps\*<sup>2</sup>/3072kbps\*<sup>2</sup>/4096kbps\*<sup>2</sup>/  
6144kbps\*<sup>2</sup>/8192kbps\*<sup>2</sup>/10240kbps\*<sup>2</sup>/12288kbps\*<sup>2</sup>/14336kbps\*<sup>2</sup>/  
16384kbps\*<sup>2</sup>/20480kbps\*<sup>2</sup>/ 24576kbps\*<sup>2</sup>

**Factory settings:**

H.264(1): 10240kbps

H.264(2): 10240kbps

The range of H.264 bit rates that can be specified varies depending on the resolution.

- 160 × 90: 64kbps to 2048kbps
- 320 × 180, 640 × 360: 64kbps to 4096kbps
- 1280 × 720: 256kbps to 8192kbps
- 1920 × 1080: 512kbps to 14336kbps
- 1920 × 1080 (60fps), 1280 × 720 (60fps): 1024kbps to 24576kbps

\*<sup>2</sup> The H.264 bit rate is limited by the [Bandwidth control (bit rate)]

(→ page 111) setting under the [Network] tab of the network setup screen [Network]. The actual bit rate may be lower than the specified value.

### Image quality

Select the image quality for H.264 images.

**Setting value:**

Low(Motion priority)/Normal/Fine(Image quality priority)

**Factory settings:** Normal

**<NOTE>**

- This setting is only enabled when [Transmission priority] (→ page 93) is set to [Constant bit rate] or [Best effort].

### Refresh interval

Select the refresh interval for H.264 images (I-frame interval: 0.2 to 5 seconds).

If errors occur frequently in the network environment, decreasing the refresh interval will reduce image distortions.

However, the frame rate may decrease.

**Setting value:**

**For 59.94Hz:**

0.2s/0.25s/0.33s/0.5s/1s/2s/3s/4s/5s

**For 50Hz:**

0.2s/0.5s/1s/2s/3s/4s/5s

**Factory settings:** 1s

### Transmission type

Select the transmission format for H.264 images.

**Setting value:**

Unicast port (AUTO)	Up to 14 users can access a single camera at the same time. [Unicast port1 (Image)] and [Unicast port2 (Audio)] will be configured automatically when images and audio are sent from the camera. We recommend selecting the [Unicast port (AUTO)] setting when the port number transmitting the H.264 images does not need to be fixed (e.g., during use within a network).
Unicast port (MANUAL)	Up to 14 users can access a single camera at the same time. [Unicast port1 (Image)] and [Unicast port2 (Audio)] must be configured manually when images and audio are sent from the camera. When transmitting H.264 images via the Internet, configure a fixed transmission port for the broadband router (hereafter referred to as "router") (→ page 110). For details, refer to the operating instructions for the router.
Multicast port	An unlimited number of users can access a single camera at the same time. When transmitting H.264 images via multicast, enter the [Multicast address], [Multicast port], and [Multicast TTL/HOPLimit].

**Factory settings:** Unicast port (AUTO)

**<NOTE>**

- For details on the maximum number for simultaneous access, see page 73.

### Unicast port1 (Image) \*1

Enter the unicast port number (used when sending images from the unit).

**Usable port number range:** 1024 to 50000

- Only even numbers can be specified.
- The port number cannot be set to 10670.

**Factory settings:**

H.264(1): 32004

H.264(2): 32014

- \*1 The unicast port number must be configured when [Transmission type] is set to [Unicast port (MANUAL)].

### Unicast port2 (Audio)\*1

**Usable port number range:** 1024 to 50000

- Only even numbers can be specified.
- The port number cannot be set to 10670.

**Factory settings:**

H.264(1): 33004

H.264(2): 33014

- \*1 The unicast port number must be configured when [Transmission type] is set to [Unicast port (MANUAL)].

### Multicast address

Enter the multicast IP address.

Images and audio will be sent to the specified IP address.

**Usable values:**

IPv4: 224.0.0.0 to 239.255.255.255

IPv6: Multicast address starting with FF

**Factory settings:**

H.264(1): 239.192.0.20

H.264(2): 239.192.0.21

**<NOTE>**

- Verify usable multicast IP addresses before entering this setting.

### Multicast port

Enter the multicast port number (used when sending images from the unit).

**Usable port number range:** 1024 to 50000

- Only even numbers can be specified.
- The port number cannot be set to 10670.

**Factory settings:** 37004

**<NOTE>**

- When sending audio from the unit, a port number with "1000" added to the multicast port number will be used.

### Multicast TTL/HOPLimit

Enter the TTL/HOPLimit value for multicast.

**Usable values:** 1 to 254

**Factory settings:** 16

**<NOTE>**

- When transmitting H.264 images via the Internet, transmitted images may not appear depending on proxy server settings, firewall settings, etc. In such cases, consult your network administrator.
- When displaying multicast images on a personal computer with multiple LAN cards installed, disable the LAN cards that are not used for reception.



### ■ Audio screen [Audio]

Configure audio settings.

<NOTE>

- Images and audio are not synchronized. Therefore, images and audio may be slightly out of sync.
- The audio may skip depending on the network environment.

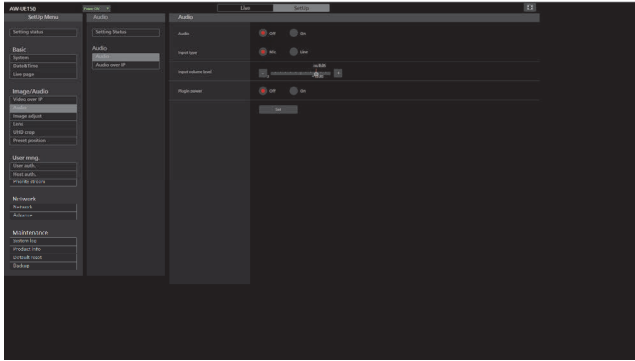

### Audio

Set the communication mode used to transmit audio data between the unit and the personal computer.

**Setting value:**

Off	Do not transmit audio data between the unit and the personal computer. All settings and controls related to audio will be disabled.
On	The personal computer receives audio data from the unit. This allows images to be viewed on the personal computer with audio. Images and audio are not synchronized.

**Factory settings:** Off

### Audio encoding format

Select the audio compression format.

**Setting value:** ???/AAC-LC (High quality)

**Factory settings:** AAC-LC (High quality)

### Audio bit rate

Set the bit rate for transmitting audio.

**Setting value:**

????

????????

**AAC-LC (High quality)**

64kbps/96kbps/128kbps

**Factory settings:** 128kbps

### Mic input volume

Set the volume of the audio from the unit when listening to it on the personal computer.

**Setting value:**

Mic High	Set the volume to high. Use this when audio is input to the camera via a microphone.
Mic Middle	Set the volume to medium. Use this when audio is input to the camera via a microphone.
Mic Low	Set the volume to low. Use this when audio is input to the camera via a microphone.
Line High	Set the volume to high. Use this when audio is input to the camera via line input.
Line Middle	Set the volume to medium. Use this when audio is input to the camera via line input.
Line Low	Set the volume to low. Use this when audio is input to the camera via line input.

**Factory settings:** Line Middle

### Plugin Power

Turn plug-in power on/off.

**Setting value:**

Off	Set plug-in power to on.
On	Set plug-in power to off.

<NOTE>

- This is only enabled when [Mic input volume] is set to [Mic High], [Mic Middle], and [Mic Low].

### ■ Image adjust/Preset position screen [Image/Position]

Display the image adjustment/preset position screen.

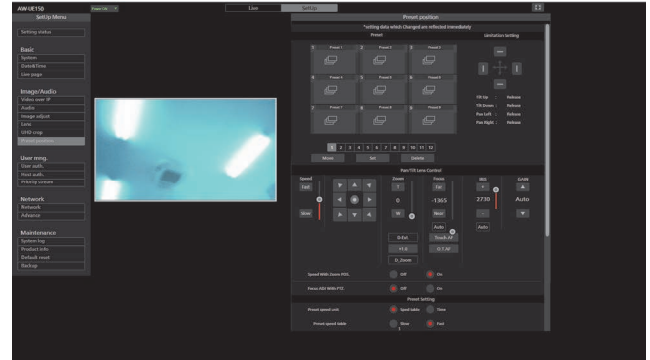

### Image adjust

When you click the [Setup] button, the image adjust screen [Image adjust] appears. (→ page 97)

### Preset position

When you click the [Setup] button, the preset position screen [Preset position] appears. (→ page 104)



## Web screen configurations (continued)

### ● Image adjust screen [Image adjust]

Adjust the image quality.

To display the Image adjust screen, click the [Setup] button for [Image adjust] at the bottom of the Image adjust/Preset position screen [Image/Position].

The settings in this screen (with the exception of [Scene]) are applied immediately.

### Scene

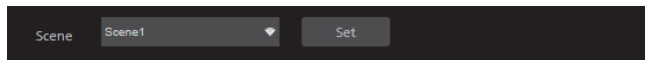

Switch the shooting mode depending on the shooting environment. Select a shooting mode based on the shooting conditions or preference.

Select a shooting mode from the pull-down menu, and click the [Set] button to switch to the selected mode.

#### Setting value:

Scene1	Modes that allow you to adjust detailed settings manually for various shooting conditions and preferences.
Scene2	
Scene3	
Scene4	

### Brightness

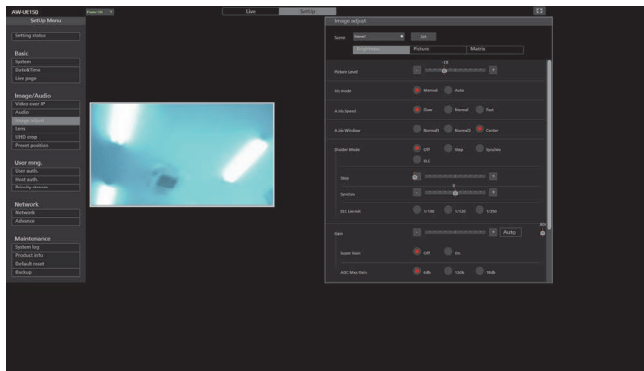

#### Picture Level

Set the target picture level for auto exposure correction.

This is enabled when any one of the following auto exposure correction functions is set to [Auto] or [ELC].

- When [Iris Mode] is set to [Auto]
- When [Shutter Mode] is set to [ELC]
- When [Gain] is set to [Auto]

**Setting range:** -50 to +50

**Factory settings:** 0

#### Iris Mode

Select whether to adjust the iris automatically or manually.

#### Setting value:

Manual	Adjust the iris manually.
Auto	Exposure correction is performed automatically to match the target level specified in [Picture Level].

#### <NOTE>

- [Iris Mode] cannot be set to [Auto] when [Frame Mix] is set to [18dB] or [24dB].

### Shutter Mode

Select for camera shutter mode.

When a higher shutter speed is selected, fast-moving subjects do not become blurred easily but the images will be darker.

#### Setting value:

Off	The shutter is set to OFF.
Step	The step shutter is set (the steps can be changed).
Synchro	The synchro shutter is set (the setting can be changed continuously).
ELC	The electronic shutter is controlled and the light quantity is adjusted automatically.

#### Factory settings: Off

The shutter speeds that can be set are listed below.

#### When 59.94Hz has been set as the unit's frequency :

	When [Step] is selected as the [Shutter Mode]	When [Synchro] is selected as the [Shutter Mode]
For 59.94p/59.94i	1/100, 1/120, 1/250, 1/500, 1/1000, 1/2000, 1/4000, 1/10000	60.15Hz to 642.21Hz (255 steps)
For 29.97p	1/30, 1/60, 1/120, 1/250, 1/500, 1/1000, 1/2000, 1/4000, 1/10000	
For 23.98p	1/24, 1/60, 1/120, 1/250, 1/500, 1/1000, 1/2000, 1/4000, 1/10000	

#### When 50Hz has been set as the unit's frequency :

	When [Step] is selected as the [Shutter Mode]	When [Synchro] is selected as the [Shutter Mode]
For 50p/50i	1/60, 1/120, 1/250, 1/500, 1/1000, 1/2000, 1/4000, 1/10000	50.15Hz to 535.71Hz (255 steps)
For 25p	1/25, 1/60, 1/120, 1/250, 1/500, 1/1000, 1/2000, 1/4000, 1/10000	

#### <NOTE>

- When [Shutter Mode] is set to [OFF] in 29.97p, 23.98p, or 25p mode, the shutter speed is set to [1/50].

### Gain

The image gain is adjusted here.

In locations which are too dark, adjust the gain upward; conversely, in locations which are too bright, adjust it downward.

**Setting range:** Auto, 0dB to 36dB

When [Auto] is set, the light quantity is adjusted automatically.

The noise increases when the gain is increased.

**Factory settings:** 0dB

#### <NOTE>

- [Gain] cannot be set to [Auto] when [Frame Mix] is set to [18dB] or [24dB].

### AGC Max Gain

When [Auto] is selected as the [Gain] setting, the maximum gain-up amount can be set.

**Setting value:** 6dB/12dB/18dB

**Factory settings:** 18dB

### Frame Mix

Select for frame addition (gain-up using sensor storage) amount.  
When frame addition is performed, it will appear as if the images are missing some frames.

**Setting value:** Off/6dB/12dB/18dB/24dB

**Factory settings:** Off

#### <NOTE>

- Under discharge tube illumination, such as fluorescent and mercury-vapor lights, the brightness may change synchronously, colors may change, and horizontal stripes may flow up and down the image.
- In such cases, we recommend setting the electronic shutter speed to 1/100 in regions with 50 Hz power supply frequency, and to OFF in regions with 60 Hz power supply frequency.
- This cannot be configured when the format is 1080/29.97p, 1080/23.98p, 1080/29.97PsF, 1080/23.98PsF, 1080/25p, or 1080/25PsF.
- [Frame Mix] cannot be set to [18dB] or [24dB] when [Iris Mode], [Gain], or [Focus Mode] is set to [Auto]. (When setting [Frame Mix] to [18dB] or [24dB], set [Iris Mode] and [Focus Mode] to [Manual] and set [Gain] to any setting other than [Auto].)

### ND Filter

Set the transmittance of the lens' built-in ND (neutral density) filter.

**Setting value:**

Through	Do not set ND filter.
1/8	Set ND filter transmittance to 1/8.
1/64	Set ND filter transmittance to 1/64.

**Factory settings:** Through

### Day/Night

Switch between standard shooting and night-vision shooting (shooting with infrared light).

**Setting value:**

Day	Standard shooting (day mode)
Night	Night-vision shooting (night mode)

**Factory settings:** Day

#### <NOTE>

- The iris will be forcibly opened.
- White balance adjustment is not possible in night mode.
- ND filter switching is not possible in night mode.
- [Pedestal] adjustment is not possible in night mode.

### Picture

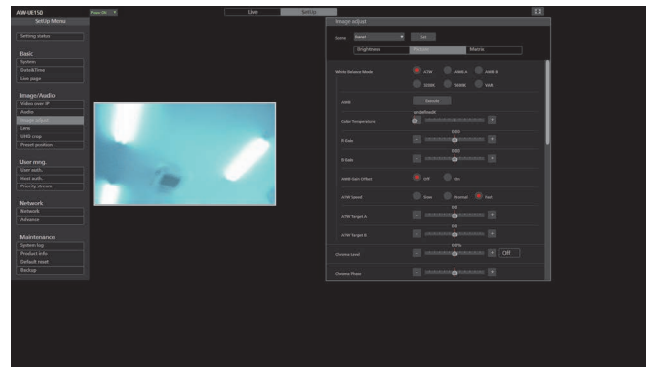

## Web screen configurations (continued)

### Chroma Level

Set here the color intensity (chroma level) of the images.

**Setting range:** OFF, -99% to 99%

**Factory settings:** 0%

### White Balance Mode

Set the white balance mode.

Select the mode when the coloring is not natural because of the nature of the light source or other factors.

If the white color serving as the reference can be recognized, subjects can be shot with natural coloring.

**Setting value:**

ATW	In this mode, the white balance is compensated for automatically, even if changes occur in the light source or color temperature, by a process of continuous and automatic adjustment.
AWB A AWB B	When [AWB A] or [AWB B] is selected and the white balance is executed, the adjustment results obtained are stored in the memory selected. When [AWB A] or [AWB B] is then selected, the white balance stored in the selected memory can be recalled.
3200K	This is the white balance mode which is ideal when a 3200K halogen light is used as the light source.
5600K	This is the white balance mode which is ideal when 5600K sunlight or fluorescent lighting is used as the light source.
VAR	Specify a color temperature between 2000K and 15000K.

**Factory settings:** AWB A

### AWB

This is used to execute automatic white balance (AWB) to set the white balance. For further details, refer to page 36.

### Color Temperature

Specify a color temperature between 2000K and 15000K.

This is enabled when [White Balance Mode] is set to [VAR].

**Setting range:** 2000K to 15000K

**Factory settings:** 3200K

### R Gain

This enables the R gain to be adjusted.

This is enabled when [White Balance Mode] is set to [AWB A], [AWB B], or [VAR].

**Setting range:** -150 to +150

**Factory settings:** 0

### B Gain

This enables the B gain to be adjusted.

This is enabled when [White Balance Mode] is set to [AWB A], [AWB B], or [VAR].

**Setting range:** -150 to +150

**Factory settings:** 0

### ABB

This is used to execute automatic black balance (ABB) to set the black balance. For further details, refer to page 38.

### Pedestal

This item is used to adjust the black level (adjust the pedestal).

These parts become darker when a negative setting is selected and, conversely, lighter when a positive setting is selected.

**Setting range:** -150 to +150

**Factory settings:** 0

### R Pedestal

This enables the R pedestal to be adjusted.

The same R pedestal setting is used for all the scenes.

**Setting range:** -100 to +100

**Factory settings:** 0

### B Pedestal

This enables the B pedestal to be adjusted.

The same B pedestal setting is used for all the scenes.

**Setting range:** -100 to +100

**Factory settings:** 0

### Detail

Turn on/off the contour (sharpness of images) adjustment of images.

**Setting value:** Off/On

**Factory settings:** On

### Master Detail

Adjust the contour (sharpness of images) of images.

Higher values result in increased sharpness in contours.

**Setting range:** 0 to 62

**Factory settings:** 0

### V Detail Level

Adjust the contour correction level in the vertical direction.

**Setting range:** -7 to +7

**Factory settings:** 0

### Detail Band

Set the boost frequency of detail.

**Setting range:** -7 (Low frequency) to +7 (High frequency)

**Factory settings:** 0

Higher frequencies result in a more detailed effect applied to the subject.

### Noise Suppress

This is selected to reduce the screen noise which is generated by the detail effect.

The higher the settings, the more the noise is reduced.

**Setting range:** 0 to 60

**Factory settings:** 1

### Flesh Tone Noise SUP.

This function is selected to make the skin of the subjects to be shot appear to be smoother and more attractive.

The higher the settings, the more the effect is enhanced.

**Setting range:** 0 to 31

**Factory settings:** 16

### Gamma Type

Select the type of gamma curve.

**Setting value:**

HD	HD (High Definition) video gamma characteristic.
SD	Gain in dark areas is higher than in HD gamma.
FILMLIKE1	Characteristic capable of reproducing better gradation in highlights than HD gamma.
FILMLIKE2	Characteristic capable of reproducing better gradation in highlights than [FILMLIKE1].
FILMLIKE3	Characteristic capable of reproducing better gradation in highlights than [FILMLIKE2].

**Factory settings:** HD

### Gamma

Adjust the gamma correction level.

Specifying smaller values results in a gentler gamma curve for the slope of low-brightness areas and sharper contrast.

Specifying larger values results in an expanded gradient for dark areas and produces brighter images. The gamma curve for low-brightness areas will be steeper, and contrast will be softer.

**Setting range:** 0.30 to 0.75

**Factory settings:** 0.45

### DRS

Set the DRS function which performs correction when video with high light/dark contrast is displayed.

You can select from a [Low], [Mid], or [High] effect level.

Depending on the scene, noise may worsen.

**Setting value:** Off/Low/Mid/High

**Factory settings:** Off

#### <NOTE>

- When DRS is enabled, knee settings ([Knee Mode], [Knee Point], [Knee Slope]) and [Gamma Type] and [Gamma] settings are disabled.

### Knee Mode

Set the operating mode for gradation compression (knee).

**Setting value:**

Off	Turn the knee function off.
Auto	Enable the knee function, and set the knee point and knee slope automatically.
Manual	Enable the knee function, and set the knee point and knee slope manually.

**Factory settings:** Auto

### Knee Point

Set the compression level (knee point) position for high-brightness video signals.

This is only enabled when [Knee Mode] is set to [Manual].

**Setting range:** 70.0% to 107.0%

**Factory settings:** 93.0%

### Knee Slope

Set the knee slope.

This is only enabled when [Knee Mode] is set to [Manual].

**Setting range:** 0 to 99

**Factory settings:** 85

#### <NOTE>

- When [DRS] is enabled, the knee setting is disabled.

### White Clip

Turn the white clip function off/on.

**Setting value:** Off/On

**Factory settings:** On

### White Clip Level

Set the white clip level.

This is only enabled when [White Clip] is set to [On].

**Setting range:** 90% to 109%

**Factory settings:** 109%

#### <NOTE>

- When [Knee Mode] is set to [Auto] and the [White Clip Level] value is changed, the knee value will also change.

### DNR

Set the digital noise reduction level for outputting bright, clear images without noise, even at night and low-light conditions.

Selecting [Low] or [High] removes noise.

However, image lag may increase.

**Setting value:** Off/Low/High

**Factory settings:** Off

### ● Matrix settings screen [Matrix Settings]

Set matrix settings.

To display the Matrix Settings screen, click the [Setup] button for [Matrix Type] at the bottom of the Image adjust/Presets position screen [Image/Position].

These settings can only be configured when [Matrix Type] is set to [User].

The settings in this screen are applied immediately.

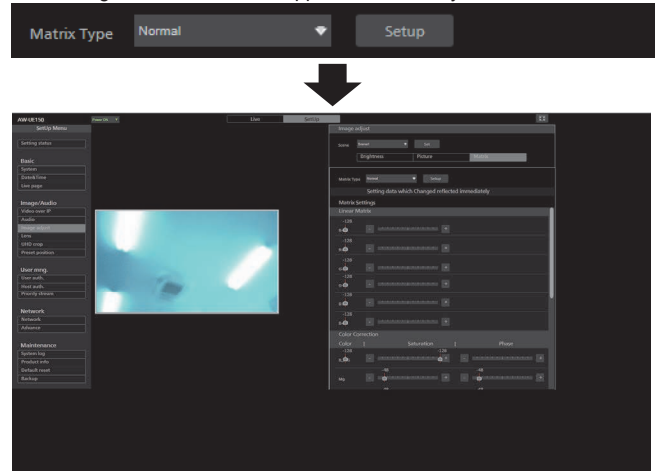

## Web screen configurations (continued)

---

### Matrix Type

Select the type of color matrix.

**Setting value:**

Normal	Load preset color matrix data, and perform saturation and hue adjustment.
EBU	
NTSC	
User	Adjust the [Linear Matrix] and [Color Correction] values.

**Factory settings:** Normal

### Linear Matrix

This can be set when [User] has been selected as the [Matrix Type] setting.

**Setting value:**

R-G	Adjust the color to between -63 to +63 for each axis direction.
R-B	
G-R	
G-B	
B-R	
B-G	

### Color Correction

This can be set when [User] has been selected as the [Matrix Type] setting.

Adjust the saturation and hue.

**Saturation**

Adjust the saturation for each color.

**Setting range:** -63 to +63

**Phase**

Adjust the hue for each color.

**Setting range:** -63 to +63

B_Mg	Color between blue and magenta
Mg	Magenta
Mg_R	Color between magenta and red
Mg_R_R	Color with a 1:3 magenta to red ratio
R	Red
R_R_YI	Color with a 3:1 red to yellow ratio
R_YI	Color between red and yellow
R_YI_YI	Color with a 1:3 red to yellow ratio
YI	Yellow
YI_G	Color between yellow and green
G	Green
G_Cy	Color between green and cyan
Cy	Cyan
Cy_B	Color between cyan and blue
B	Blue







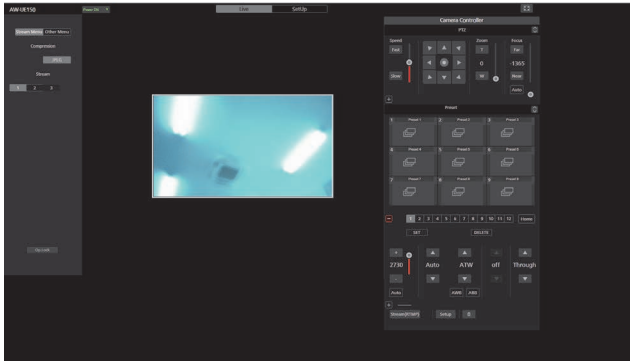

## Web screen configurations (continued)

### ● Preset position screen [Preset position]



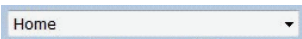

Perform operations and adjustments related to preset positions.  
To display the Preset position screen, click the [Setup] button for [Preset position] in the Image adjust/Preset position screen [Image/Position]. The settings in this screen (with the exception of [Preset]) are applied immediately.







### Preset

	This selects the preset position to be operated from the pull-down menu.
	This is used to register the current status in the preset position now selected on the pull-down menu. It does not function if [Home] has been selected on the pull-down menu.
	The camera direction moves to the preset position which is now selected on the pull-down menu. The settings that are reproduced at this position are the settings which were established on the [Preset Scope] menu (→ page 61, page 88, page 106). The camera direction moves to the home position if [Home] has been selected on the pull-down menu. In such cases, the image output during movement to the home position will not freeze, regardless of the [Freeze During Preset] setting.
	This is used to delete the preset position setting which is currently being selected. It does not function if [Home] has been selected on the pull-down menu.



### Zoom

	Use this to adjust the zoom (magnification) in the Wide direction.
	Use this to adjust the zoom (magnification) to 1.0x.
	Use this to adjust the zoom (magnification) in the Tele direction.
	Use this to enable or disable the digital zoom.
	Use this to enable or disable the digital extender. This operates only when digital zoom is disabled.

### Focus

	Use this to adjust the focus in the "Near" direction. It does not work during automatic adjustments.
	When this is pressed while the focus is being adjusted manually, the focus will be temporarily adjusted automatically. It does not work during automatic adjustments.
	Use this to adjust the focus in the "Far" direction. It does not work during automatic adjustments.
	Use this to switch between auto and manual focusing.

### Brightness

	Use this to make the image darker. It does not work during automatic adjustments.
	Use this to make the image lighter. It does not work during automatic adjustments.
	Use this to switch the picture brightness adjustment between auto and manual.

### Control pad and its buttons

	<p>To adjust the image in the horizontal or vertical direction (panning or tilting), left-click the pad and the buttons.</p> <p>The more the outside of the pad is clicked, the faster the camera operates. Adjustment is also possible by dragging the mouse.</p> <p>Right-click the pad to initiate zooming and focusing.</p> <p>When the top half of the pad is clicked in the up or down direction, the zoom (magnification) is adjusted in the Tele direction; conversely, when the bottom half of the pad is clicked, the zoom is adjusted in the Wide direction.</p> <p>When the left half of the pad is clicked in the left or right direction, the focus is adjusted in the Near direction; conversely when the right half of the pad is clicked, the focus is adjusted in the Far direction. The zooming can also be adjusted by operating the mouse wheel.</p>
---	---

### <NOTE>

- When the mouse is used for dragging and dropping from the control pad area to a position outside this area, the panning, tilting and other operations will not stop. In a case like this, click the control pad area to stop these operations.

### Speed

	Use this to select the speed at which the pan, tilt, zoom, focus, and brightness operations are to be performed.
---	--





## Web screen configurations (continued)

### Speed With Zoom POS.

[Off] or [On] is set here for the function used to adjust the pan-tilt adjustment speed in conjunction with the zoom magnification.

**Setting value:**

Off	The panning and tilting operations will not become slower in the zoom status.
On	The panning and tilting operations will become slower in the zoom status. This function has no effect during preset operations.

### Focus ADJ With PTZ.

[Off] or [On] is set here for the function which compensates for out-of-focusing when it occurs during panning, tilting or zooming operations.

**Setting value:**

Off	Out-of-focusing is not compensated.
On	Out-of-focusing is compensated.

When [Off] is set, adjust the focus as required after zooming or set [Focus Mode] to [Auto].

This item can be selected only when [Manual] has been selected as the [Focus Mode] setting.

### Preset Setting

#### Preset Speed Table

Set the preset speed table (Slow, Fast).

During preset playback, presets are performed at [Preset Speed] (1 to 30) values that are based on the table set here.

**Setting value:**

Slow	Set the preset speed table to slow.
Fast	Set the preset speed table to fast.

#### Preset Speed

Set the pan/tilt movement speed used when recalling camera orientation information registered to the preset memory (30 steps).

**Setting range:** 1 to 30

**<NOTE>**

- When you set large [Preset Speed] values, the image may sway when the movement stops.
- When [Preset Speed Table] is set to [Fast], [Preset Speed] values equivalent to the AW-HE120 will be applied.

#### Preset Scope

Selected here are the setting items to be recalled when the contents of the preset memory are regenerated.

**Setting value:**

Mode A	Pan, Tilt, Zoom (including digital zoom), Focus, Iris, Gain, white balance adjustment value
Mode B	Pan, Tilt, Zoom (including digital zoom), Focus, Iris
Mode C	Pan, Tilt, Zoom (including digital zoom), Focus

### Freeze During Preset

Turn the function for freezing images during preset playback off/on. When this is set to [On], preset playback is performed with a still of the image immediately preceding the start of preset playback being output. The image freeze is released when preset playback is finished.

**Setting value:**

Off	Do not freeze images during preset playback.
On	Freeze images during preset playback.

### Limitation Setting

This establishes the up, down, left and right limit settings of the pan-tilt head.

First, move the pan-tilt head to the position where the limit is to be set, and press the corresponding button below to set the direction (up, down, left or right) in which the limit is to be set.

After each setting has been selected, press the [Set] button to enter the setting.

**Setting value:**

Tilt Up	Use this to save the current position as the upward limit.
Tilt Down	Use this to save the current position as the downward limit.
Pan Left	Use this to save the current position as the leftward limit.
Pan Right	Use this to save the current position as the rightward limit.
Set/Release	Use this to enable or disable the limit setting in each direction.

**User management screen [User mng.]**

The users and personal computers (IP addresses) that can access the unit from personal computers and mobile terminals are registered in the User management screen [User mng.]. The User management screen [User mng.] consists of [User auth.], [Host auth.] and [Priority stream] tabs.

**User authentication screen [User auth.]**

Click the [User auth.] tab of User management screen [User mng.]. Configure the user authorization settings for the personal computers and mobile terminals that can access the unit. Up to 24 users can be registered.

**<NOTE>**

- If user authentication fails more than 8 times within a 30-second period from the same IP address (personal computer), access to the unit will be disabled for a certain period.

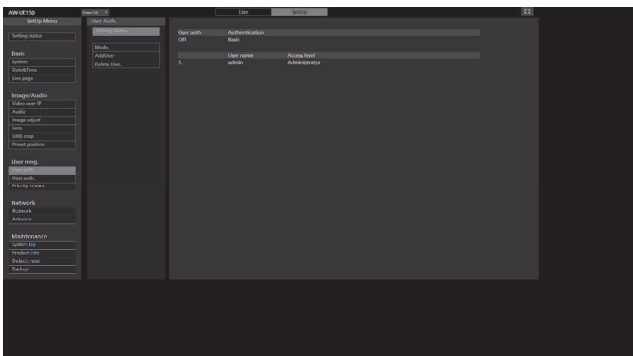
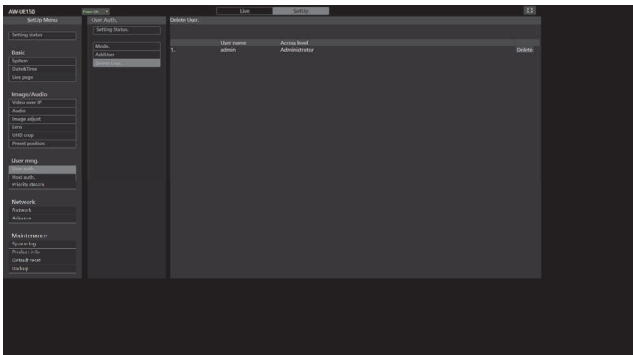
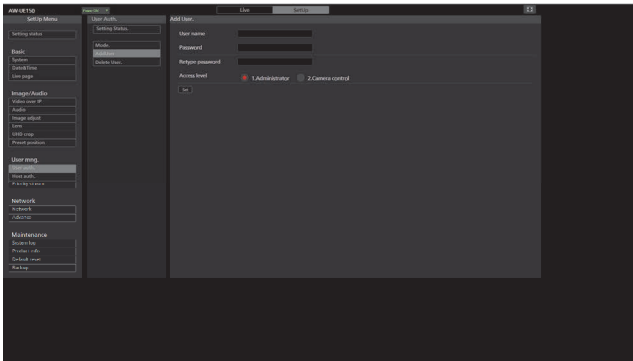
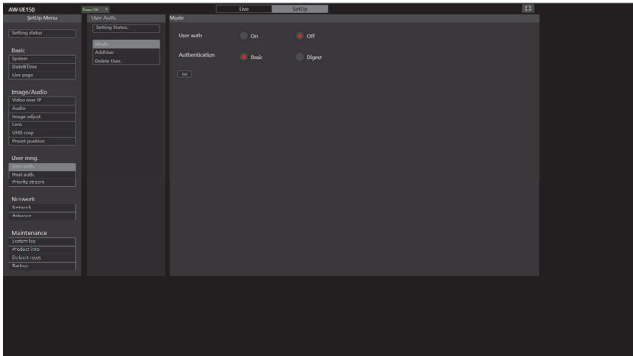

**User auth.**

User authorization is set to [On] or [Off] here.

**Setting value:**

On	Perform user authentication.
Off	Do not perform user authentication.

**Factory settings:** Off

**Authentication**

Specify the method of user authentication to use.

**Setting value:**

Digest or Basic	Use digest authentication or basic authentication.
Digest	Use digest authentication.
Basic	Use basic authentication.

**Factory settings:** Digest or Basic

**<NOTE>**

- If you change the [Authentication] setting, close the web browser and perform access again.
- When [User auth.] is set to [On], network connection with the AW-RP50 will be disabled.
- When [User auth.] is set to [On] while [Authentication] is set to [Digest], network connection with the AW-RP50, AW-RP120, and AK-HRP200 will be disabled.

**User name**

Input the user name.

Maximum number of characters	1 to 32 characters
Invalid characters	" & ; ¥

**Factory settings:** blank

## Web screen configurations (continued)

### Password/Retype password

Input the password.

Maximum number of characters	4 to 32 characters
Invalid characters	" &

Factory settings: blank

#### <NOTE>

- If you enter a new name for a registered user and click the [Set] button, the user information will be overwritten.

### Access level

Select one of the following settings as the user access level.

Setting value:

1. Administrator	This access level allows the user to perform all the unit's operations.
2. Camera control	This access level allows only live screen [Live] operations to be performed. The unit cannot be set.

Factory settings: 3. Live only

### User check

You can view registered users by clicking [▼] for [User check].

A registered user is indicated in the form of "Registered user name [Access level]". (Example: admin[1])

You can delete selected users by clicking the [Delete] button at the right.

### Host authentication screen [Host auth.]

Click the [Host auth.] tab of User management screen [User mng.].

Configure the host authorization settings that restrict the personal computers (IP addresses) that can access the unit.

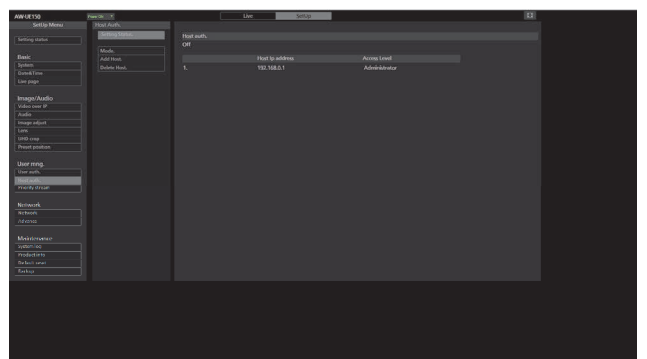
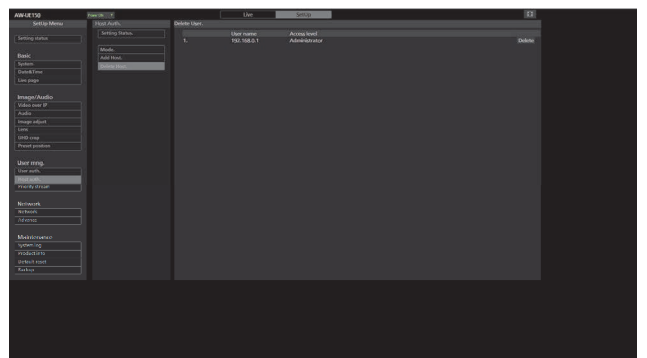
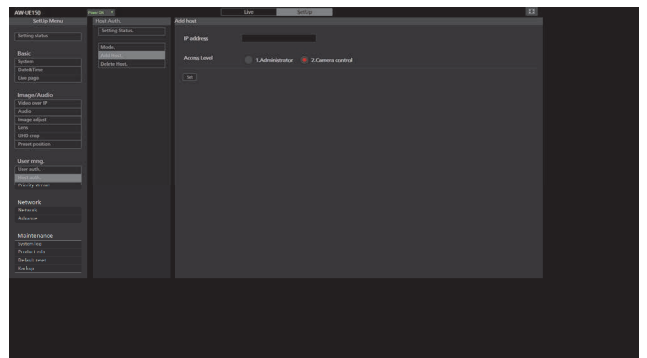
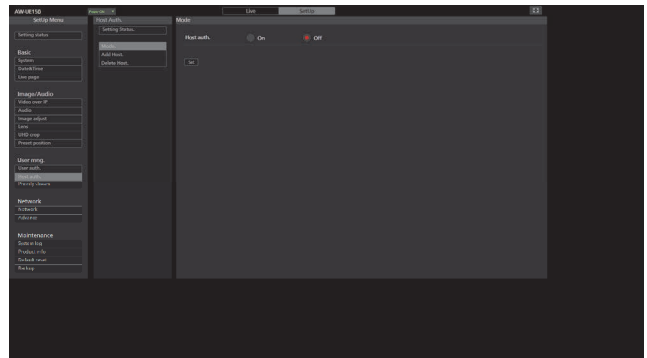

### Host auth.

Host authorization is set to [On] or [Off] here.

Setting value:

On	Perform host authentication.
Off	Do not perform host authentication.

Factory settings: Off

### IP address

The IP address of the personal computer from which access to the camera is allowed is input here. The host name cannot be input as the IP address.

#### <NOTE>

- When the "IP address/subnet mask length" is input, the personal computers which are allowed to access the camera can be restricted on a subnet by subnet basis.  
If, for instance, "192.168.0.1/24" has been input and the [2. Camera control] setting has been selected as the [Access level] setting, the personal computers from "192.168.0.1" to "192.168.0.254" will be able to access the camera at the [2. Camera control] access level.
- When an already registered IP address is input and the [Set] button is clicked, the host information will be overwritten.

### Access level

Select one of the following settings as the host access level.

#### Setting value:

1. Administrator	This access level allows the user to perform all the unit's operations.
2. Camera control	This access level allows only Live screen [Live] operations to be performed. The unit cannot be set.

**Factory settings:** 3. Live only

### Host check

You can view registered host IP addresses by clicking [▼] for [Host check].

A host is indicated in the form of "Registered IP address [Access level]". (Example: 192.168.0.21 [1])

You can delete selected hosts (IP addresses) by clicking the [Delete] button at the right.

### Priority stream screen [Priority stream]

Click the [Priority stream] tab of User management screen [User mng.].

Selected on this screen are the settings for the priority stream which enables the images to be sent with no reduction in image quality or image refresh speed even when a multiple number of users are accessing the unit at the same time.

### Priority stream

#### Activation

Whether to use priority stream transmission is set here using [On] or [Off].

#### Setting value:

On	Use priority stream transmission.
Off	Do not use priority stream transmission.

**Factory settings:** Off

#### <NOTE>

- When [Activation] is set to [On], the number of users that can access the unit may be restricted.

#### Destination IP address (1)

The IP address of the first send destination is input here.

#### Destination IP address (2)

The IP address of the second send destination is input here.

#### Stream Type

Select the stream type.

#### Setting value:

JPEG(1)	JPEG(1) images are sent.
JPEG(2)	JPEG(2) images are sent.
JPEG(3)	JPEG(3) images are sent.
H.264(1) <a href="#">Windows I.E.11</a>	H.264(1) images are sent.
H.264(2) <a href="#">Windows I.E.11</a>	H.264(2) images are sent.
H.264(3) <a href="#">Windows I.E.11</a>	H.264(3) images are sent.
H.264(4) <a href="#">Windows I.E.11</a>	H.264(4) images are sent.

**Factory settings:** JPEG(1)

#### <NOTE>

- When [Transmission priority] (→ page 93) is set to [Best effort] for [H.264], transmissions will occur at a variable bit rate between the maximum and minimum bit rate depending on the connection status of the other users. [Windows I.E.11](#)

#### Refresh interval

Select the frame rate.

This is enabled only when [Stream Type] is set to [JPEG(1)], [JPEG(2)], or [JPEG(3)].

#### Setting value:

**For 59.94Hz:**

1fps/2fps/3fps/5fps/6fps\*<sup>1</sup>/10fps\*<sup>1</sup>/15fps\*<sup>1</sup>/30fps\*<sup>1</sup>

**For 50Hz:**

1fps/2fps/5fps/10fps\*<sup>1</sup>/12.5fps\*<sup>1</sup>/25fps\*<sup>1</sup>

**Factory settings:** 1fps

- \*<sup>1</sup> When [H.264 transmission] is set to [On], the frame rate may be slower than the specified value in some cases.

### Network setup screen [Network]

Configure network settings in the Network setup screen. The Network setup screen [Network] consists of [Network] and [Advanced] tabs.

#### Network setup screen [Network]

Click the [Network] tab of the Network setup screen [Network].

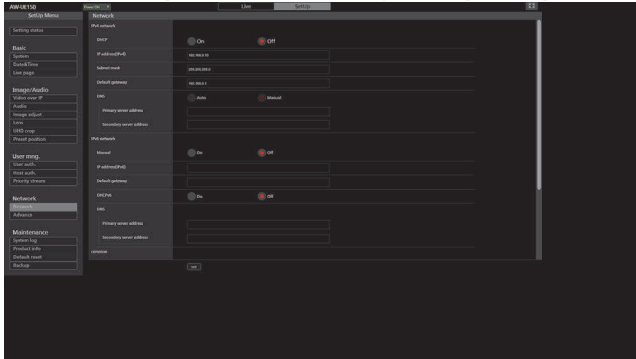

The following information is required to configure network settings. Consult your network administrator or Internet service provider.

- IP address
- Subnet mask
- Default gateway (when using a gateway server or router)
- HTTP port
- DNS primary and secondary server addresses (when using DNS)

### ● IPv4 network

#### Network Settings

Select the method in which the IP address is configured.

**Setting value:**

Static	Enter the IP address in the [IP address(IPv4)] field.
DHCP	Use the DHCP function to configure the IP address.
Auto(AutoIP)	Use the DHCP function to configure the IP address. If the DHCP server cannot be found, the IP address will be configured automatically.
Auto(Advanced)	Use the DHCP function to browse network address information, and configure an unused IP address for the camera as a fixed IP address. The IP address configured will be automatically determined by the camera from within the subnet mask range. If the DHCP server cannot be found, the IP address will be set to 192.168.0.10.

**Factory settings:** Static

#### <NOTE>

- If the DHCP server cannot obtain an IP address with [Auto(AutoIP)], search for an IP address between 169.254.1.0 to 169.254.254.255 on the same network, and configure the IP address.
- When set to anything other than [Static], AW-RP120's automatic configuration of IP address (AUTO IP) and AW-RP50's automatic configuration of IP address (AUTO SET IP) cannot be used.

#### IP address (IPv4)

Input the unit's IP address here when the DHCP function is not going to be used. Input an address that will not duplicate an existing IP address which has been set for a personal computer or another network camera.

**Factory settings:** 192.168.0.10

#### <NOTE>

- Multiple IP addresses cannot be used even when the DHCP function is used. For details on the DHCP server settings, consult your network administrator.

#### Subnet Mask

Input the unit's subnet mask here if the DHCP function is not going to be used.

**Factory settings:** 255.255.255.0

#### Default gateway

Input the unit's default gateway if the DHCP function is not going to be used.

**Factory settings:** 192.168.0.1

#### <NOTE>

- Multiple IP addresses cannot be used for the default gateway even when the DHCP function is used. For details on the DHCP server settings, consult your network administrator.

#### DNS

Whether the DNS server address is to be acquired automatically (Auto) or manually (Manual) is input here.

If [Manual] has been selected, the DNS settings must be established. If [Auto] is selected when the DHCP function is going to be used, the DNS server address is acquired automatically.

For further details, consult your system administrator.

**Setting value:** Auto/Manual

**Factory settings:** Manual

## Web screen configurations (continued)

### Primary server address

#### Secondary server address

Input the IP address of the DNS server if the [Manual] setting has been selected for [DNS].

For details on the IP address of the DNS server, consult your system administrator.

### ● IPv6 network

#### Manual

Enable or disable manual configuration of the IPv6 address.

##### Setting value:

On	Enter the IPv6 address manually.
Off	Disable manual entry of the IPv6 address.

Factory settings: Off

#### IP address (IPv6)

When [Manual] is set to [On], the IPv6 address must be entered manually.

Be sure to enter an address unique from other devices.

##### <NOTE>

- When connecting to the manually specified IP address through a router, use an IPv6-compatible router, and enable the automatic configuration function for the IPv6 address. Be sure to configure an IPv6 address that includes the prefix information provided by the IPv6-compatible router. For details, refer to the operating instructions for the router.

#### Default gateway

When [Manual] is set to [On] for [IPv6 network], enter the default gateway for the unit's IPv6 network.

Factory settings: blank

#### DHCPv6

Enable or disable use of the IPv6 DHCP function.

Configure the DHCP server so that the same IP address is not configured for a personal computer that does not use the DHCP function and other network cameras. For details on server settings, consult your network administrator.

##### Setting value:

On	Use the IPv6 DHCP function.
Off	Do not use the IPv6 DHCP function.

Factory settings: Off

#### Primary DNS server address

#### Secondary DNS server address

Enter the IPv6 address of the DNS server.

For details on the IPv6 address of the DNS server, consult your system administrator.

### ● Common (to IPv6/IPv4)

#### HTTP port

Port numbers are allocated separately.

Setting range: 1 to 65535

The following port numbers are used by the unit so they cannot be used.

20, 21, 23, 25, 42, 53, 67, 68, 69, 110, 123, 161, 162, 443, 554, 995, 10669, 10670, 59000 to 61000

Factory settings: 80

#### Line speed

Select one of the following data line speeds. Normally, it is recommended that the [Auto] default setting be used.

##### Setting value:

Auto	The line speed is set automatically.
100 M-Full	100 Mbps full duplex
100 M-Half	100 Mbps half duplex
10 M-Full	10 Mbps full duplex
10 M-Half	10 Mbps half duplex

Factory settings: Auto

#### Max RTP packet size

Specify whether to limit the size of RTP packets sent from the camera when using RTP to view camera images.

##### Setting value:

Unlimited(1500byte)	Unlimited (1500 byte)
Limited(1280byte)	Limited (1280 byte)

Factory settings: Unlimited(1500byte)

Normally, it is recommended that the [Unlimited(1500byte)] setting be used.

Select [Limited(1280byte)] when the packet size of the used communication line is limited. For details on the maximum packet size of communication lines, consult your network administrator.

#### HTTP max segment size(MSS)

Select whether to limit the maximum segment size (MSS) transmitted by a camera when viewing camera images using HTTP.

##### Setting value:

Unlimited(1460byte)	Unlimited (1460 byte)
Limited(1280byte)	Limited (1280 byte)
Limited(1024byte)	Limited (1024 byte)

Factory settings: Unlimited(1460byte)

Normally, it is recommended that the default setting be used.

Select [Limited(1024byte)]/[Limited(1280byte)] when the maximum segment size (MSS) of the used communication line is limited. For details on the maximum segment size (MSS) of communication lines, consult your network administrator.

#### Bandwidth control (bit rate)

Select the amount of data to be distributed.

##### Setting value:

Unlimited/64kbps/128kbps/256kbps/384kbps/512kbps/768kbps/1024kbps/2048kbps/4096kbps/8192kbps

Factory settings: Unlimited

##### <NOTE>

- Set [Audio] to [Off] when selecting [64kbps]. (→ page 58, page 96)
- When [Bandwidth control (bit rate)] is set to a low value, the SnapShot button may not work depending on the use environment. In such a case, select [JPEG] with the [Compression] button in the Live screen [Live] and execute SnapShot when distributing images in the smallest resolution.

### Easy IP Setup accommodate period

Select [20min] or [Unlimited] as the time for enabling the operation of the network settings from the Easy IP Setup Software.

#### Setting value:

20min	The setting operations from the Easy IP Setup Software are enabled for 20 minutes after the camera has started operating.
Unlimited	The setting operations from the Easy IP Setup Software are enabled at all times.

Factory settings: Unlimited

#### <NOTE>

- The camera screen can be opened because the camera display in the Easy IP Setup Software is constantly enabled.
- For details on the address settings of each server, consult your network administrator.
- The port forwarding function converts a global IP address to a private IP address, and includes "static IP masquerade" and "network address translation (NAT)". This function is set to the router.
- To access the camera via the Internet after connecting it to a router, it will be necessary to set an individual HTTP port No. for each network camera and to convert the address using the router's port forwarding function. For details, refer to the operating instructions for the router.

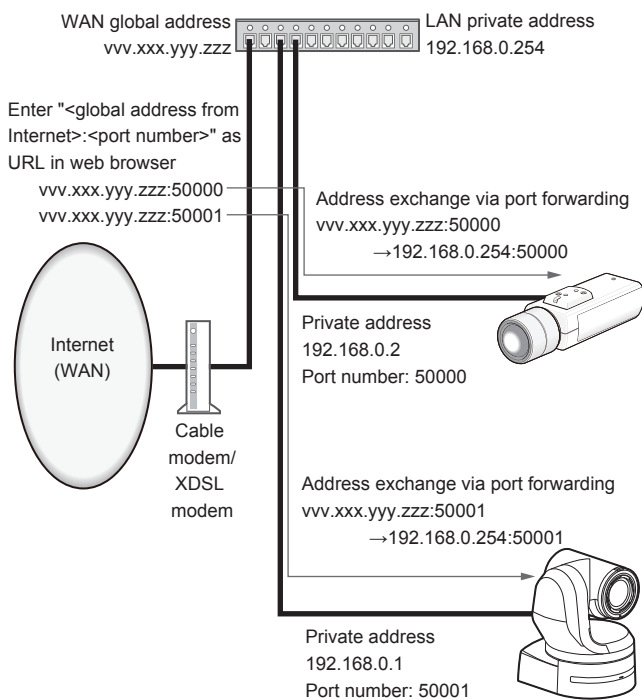

### Recommended network setting for internet

Perform the recommended settings to connect the camera to the Internet.

Clicking the [Set] button displays a dialog box telling the user that item settings will be changed. After confirming this, click the [OK] button.

#### • [JPEG/H.264] tab in the Image screen [Image]

##### JPEG(1)

Image capture size: 640×360

##### JPEG(2)

Image capture size: 320×180

##### JPEG(3)

Image capture size: 160×90

**H.264(1) • H.264(2) • H.264(3) • H.264(4)** [Windows I.E. 11](#)

Internet mode (over HTTP): On

Transmission priority: Best effort

**H.264(1)** [Windows I.E. 11](#)

Image capture size: 1280×720

Max bit rate (per client): Max1024kbps, Min1024kbps

**H.264(2)** [Windows I.E. 11](#)

Image capture size: 640×360

Max bit rate (per client): Max1024kbps, Min128kbps

**H.264(3)** [Windows I.E. 11](#)

Image capture size: 320×180

Max bit rate (per client): Max1024kbps, Min128kbps

**H.264(4)** [Windows I.E. 11](#)

Image capture size: 160×90

Max bit rate (per client): Max1024kbps, Min128kbps

#### • [Network] tab in the Network setup screen [Network]

##### Common IPv6/v4

Max RTP packet size: Limited(1280byte)

HTTP max segment size(MSS): Limited(1280byte)



### ■ Advanced network setting screen [Advanced]

Click the [Advanced] tab in the network setup screen [Network].

Settings relating to the NTP, UPnP, HTTPS, SNMP, and Diffserv functions are performed here.

Click the links to each item to move to the respective setting page.

#### ● NTP

Settings relating to the NTP server address and port No. are performed here.

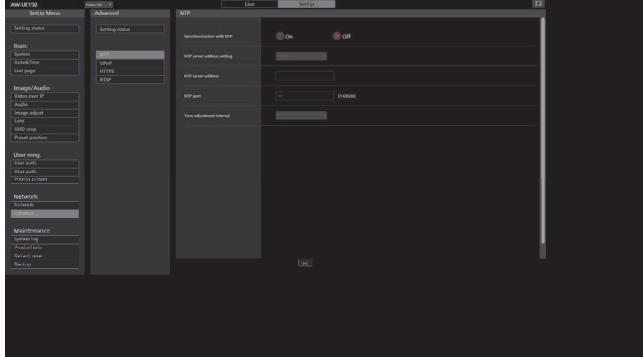

#### Time adjustment

Sets the method to adjust the time. The adjusted time will be used as this unit's standard time.

**Setting value:**

Manual	The time set in [Date/time] of the Basic screen [Basic] will be used as this unit's standard time.
Synchronization with NTP server	The time adjusted automatically through synchronization with the NTP server will be used as this unit's standard time.

**Factory settings:** Synchronization with NTP server

#### NTP server address setting

Select the method to acquire the NTP server address.

**Setting value:**

Auto	Acquires the NTP server address from the DHCP server.
Manual	Sets the address by inputting the NTP server address in [NTP server address].

**Factory settings:** Manual

#### <NOTE>

- To acquire the NTP server address from the DHCP server, [Network Settings] (→ page 110) must be set to either [DHCP], [Auto(AutoIP)] or [Auto(Advanced)] in the [Network] tab of the network setup screen [Network].

#### NTP server address

When [Manual] is selected in the [NTP server address setting], input the IP address or host name of the NTP server.

Maximum number of characters	1 to 128 characters
Characters that can be entered	Alphanumeric characters, symbols : . _ -

**Factory settings:** blank

#### <NOTE>

- To input the [NTP server address] host name, the [DNS] setting must be selected on the [Network] tab of the network setup screen [Network]. (→ page 110)

#### NTP port

Input the port No. of the NTP server.

**Port No. that can be selected:** 1 to 65535

The following port numbers are used by the unit so they cannot be used.

20, 21, 23, 25, 42, 53, 67, 68, 69, 80, 110, 161, 162, 443, 554, 995, 10669, 10670

**Factory settings:** 123

#### Time adjustment interval

Selects the interval (1 to 24 hours in 1-hour increments) for acquiring the time from the NTP server.

**Setting range:** 1 h to 24 h

**Factory settings:** 1 h

#### Time zone

Selects the time zone according to the region where the camera is being used.

**Factory settings:**

(GMT)Greenwich Mean Time: Dublin, Edinburgh, Lisbon, London

#### Summer time(daylight saving)

Sets whether to use summer time.

Selects the time zone that corresponds with the region in which the unit is going to be used.

**Setting value:**

In	Sets the time to summer time.
Out	Cancels summer time.
Auto	Switches to summer time according to the start/end time and date settings (time, day, week, month).

**Factory settings:** Out

#### Start time & date

#### End time & date

Sets the summer time start/end time and date by time, day, week and month when [Auto] is selected in the [Summer time(daylight saving)] setting.

#### ● UPnP

This unit supports UPnP (Universal Plug and Play). Using the UPnP function allows the following to be set automatically.

- Sets the router's port forwarding function. (However, a UPnP-compatible router is necessary.)  
This setting is useful when accessing the camera from the Internet or a portable terminal.
- It is set so that a short cut to the camera is created in the [Network] folder of your personal computer and that short cut is automatically renewed even when the camera's IP address is changed.

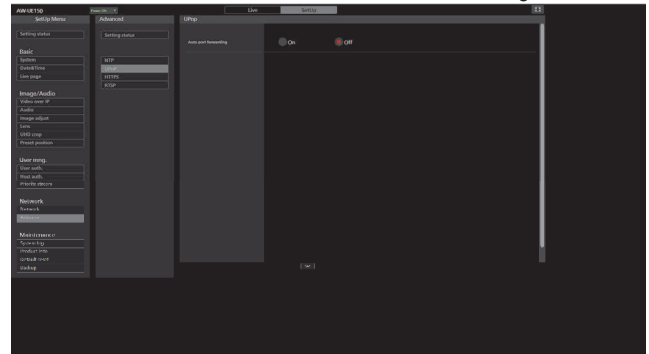

### Auto port forwarding

Whether to use the router's port forwarding function is set by selecting [On] or [Off].

To use the automatic port forwarding function, the used router must support UPnP and the UPnP function must be enabled.

#### Setting value:

On	Uses the router's port forwarding function.
Off	The router's port forwarding function is not used.

#### Factory settings: Off

##### <NOTE>

- The port number may be changed by automatic port forwarding. If the number is changed, the port No. of the camera registered to the personal computer or recorder must be changed.
- The UPnP function may be used when the camera is connected to the IPv4 network. IPv6 is not supported.
- To confirm that automatic port forwarding is correctly set, click the [Status] tab in the maintenance screen [Maintenance] to confirm that the [UPnP] status is set to [Enable]. (→ page 113)  
If [Enable] is not displayed, refer to "Cannot access the Internet from the Camera" in the "Troubleshooting" section. (→ page 135)

### Camera short cut

Whether to create a camera short cut in the [Network] folder of your personal computer is set by selecting [On] or [Off].

Select [On] to create a camera short cut.

To use the camera short cut function, enable the UPnP function in advance in your personal computer.

#### Setting value:

On	Creates a camera short cut in the [Network] folder of your personal computer.
Off	No camera short cut is created in the [Network] folder of your personal computer.

#### Factory settings: Off

##### <NOTE>

- To display a camera short cut in the Windows [Network] folder, the Windows component must be added. Refer to the information below to enable UPnP.

#### Windows 7

[Start]→[Control Panel]→[Network and Internet]→[Network and Sharing Center]→[Change Advanced Sharing Settings]→select [Enable Network Discovery] in [Network Discovery]→click [Save Changes]→Complete

#### Windows 8

[Start]→Select [All Applications]→[Control Panel]→[Network and Internet]→[Network and Sharing Center]→[Change Advanced Sharing Settings]→select [Enable Network Discovery] in [Network Discovery]→click [Save Changes]→Complete

### ● HTTPS

Using the HTTPS function enables access to the camera to be encrypted and communication safety to be improved.

See page 116 for more details on the HTTPS setup method.

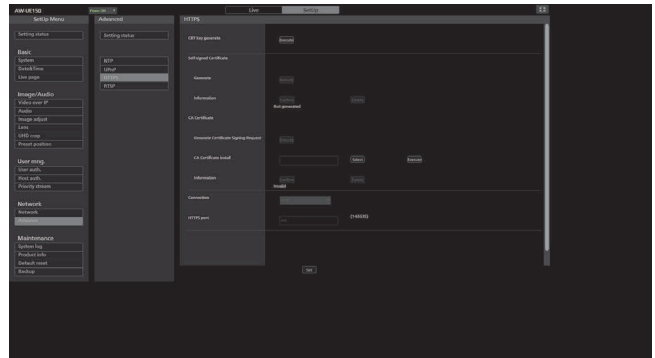

### CRT key generate

A CRT key (SSL encryption key) is generated by HTTPS.

To generate a CRT key, click the [Execute] button to display the [CRT Key Generate] dialog.

For more details, refer to "Generating a CRT key (SSL encryption key)" (→ page 117).

### Self-signed Certificate - Generate

A self-signed security certificate is generated by HTTPS. (Self-signed Certificate)

To generate a self-signed certificate (security certificate), click the [Execute] button to display the [Self-signed Certificate - Generate] dialog and perform the operation.

For more details, refer to "Generating a self-signed certificate (security certificate)" (→ page 117).

### Self-signed Certificate - Information

This displays information relating to the self-signed certificate (security certificate).

When the [Confirm] button is clicked, the registered content of the generated self-signed certificate (security certificate) is displayed in the [Self-signed Certificate - Confirm] dialog.

Click the [Delete] button to delete the generated self-signed certificate (security certificate).

### CA Certificate - Generate Certificate Signing Request

When using a security certificate issued by the Certificate Authority (CA) as a security certificate for HTTPS, a Certificate Signing Request (CSR) is generated for application to the Certificate Authority (CA).

To generate a Certificate Signing Request (CSR), click the [Execute] button to display the [Certificate Signing Request (CSR) Generate] dialog and perform the operation.

For more details, refer to "Generating a Certificate Signing Request (CSR)" (→ page 118).

### CA Certificate - CA Certificate install

This displays information relating to server certificates (security certificates) issued by the Certificate Authority (CA), which are to be or are already installed.

In the [File Open] dialog, which is displayed by clicking the [Browse] button, select the file of the server certificate (security certificate) issued by the Certificate Authority (CA) and click the [Execute] button to install the server certificate (security certificate).

If the server certificate (security certificate) is installed, its file name will be displayed.

For more details, refer to "Installing a Server Certificate" (→ page 119).

### CA Certificate - Information

This displays information relating to the server certificate (security certificate).

When the [Confirm] button is clicked, the registered content of the installed server certificate (security certificate) is displayed in the [Server Certificate - Confirm] dialog. If the server certificate (security certificate) is not installed, the content of the generated Certificate Signing Request (CSR) is displayed.

Click the [Delete] button to delete the installed server certificate (security certificate).

#### <NOTE>

- To delete an enabled server certificate (security certificate), confirm that there is a backup to the said certificate in your personal computer or recording media. A server certificate (security certificate) will be needed to reinstall it.

### Connection

This sets the method to connect to the unit.

#### Setting value:

HTTP	Only HTTP connection is possible.
HTTPS	Only HTTPS connection is possible.

#### Factory settings: HTTP

For more details, refer to "Setting the Connection Method" (→ page 119).

#### <NOTE>

- When using an HTTPS connection, network connection with the AW-RP120, AW-RP50, and AK-HRP200 will be disabled.

### HTTPS port

This sets the Port No. to be used with HTTPS.

#### Port No. that can be selected: 1 to 65535

The following port numbers are used by the unit so they cannot be used.

20, 21, 23, 25, 42, 53, 67, 68, 69, 80, 110, 123, 161, 162, 554, 995, 10669, 10670, 59000 to 61000

#### Factory settings: 443

#### <NOTE>

- This unit will restart if the connection method is changed.
- When using a self-signed certificate:
  - A warning screen is displayed when accessing the camera by HTTPS for the first time. Install the self-signed certificate (security certificate) in your personal computer in accordance with the screen instructions. (→ page 120)
- When using a server certificate:
  - Install the Certificate Authority (CA) root certificate or intermediate certificate in your web browser in advance.
  - Follow the Certificate Authority (CA) procedures to acquire and install root certificates and intermediate certificates.
- When accessing the camera by HTTPS, the image display speed and frame rate of the moving image may reduce.
- When accessing the camera by HTTPS, it may take some time for the images to be displayed.
- When accessing the camera by HTTPS, images may be disturbed and sound may be interrupted.
- The maximum number of cameras that can be connected simultaneously depends on the maximum image size and distribution format.

### RTSP

This performs settings related to the RTSP function. The RTSP function sets the RTSP transmission port and RTSP Request URL used during IP image transmission.

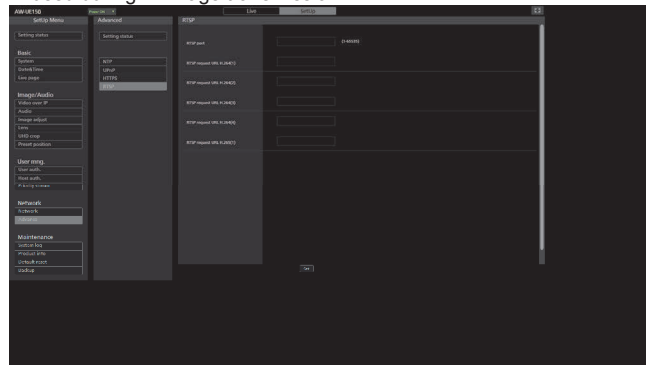

### RTSP port

Sets the RTSP reception port no.

#### Port No. that can be selected: 1 to 65535

The following port numbers are used by the unit so they cannot be used.

20, 21, 23, 25, 42, 53, 67, 68, 69, 80, 110, 123, 161, 162, 443, 995, 10669, 10670, 59000 to 61000

#### Factory settings: 554

### RTSP Request URL (1) to (4)

Sets up the URL for RTSP when making IP image transmission demands to this unit.

RTSP Request URL (1)	RTSP URL for H.264 (1) image transmission
RTSP Request URL (2)	RTSP URL for H.264 (2) image transmission
RTSP Request URL (3)	RTSP URL for H.264 (3) image transmission
RTSP Request URL (4)	RTSP URL for H.264 (4) image transmission

#### Factory settings:

RTSP Request URL (1)	MediaInput/h264/stream_1
RTSP Request URL (2)	MediaInput/h264/stream_2
RTSP Request URL (3)	MediaInput/h264/stream_3
RTSP Request URL (4)	MediaInput/h264/stream_4

- Up to 255 characters can be entered.
- The following characters can be displayed.

Numeric characters	0123456789
Alphabetical characters (upper and lower cases)	ABCDEFGHIJKLMNOPQRSTUVWXYZ abcdefghijklmnopqrstuvwxyz
Symbols	/ - _

#### <NOTE>

- [RTSP Request URLs (1)] to [RTSP Request URLs (4)] cannot have the same URL.

## ■ HTTPS settings [HTTPS]

This encrypts access to the camera and sets HTTPS to improve communication safety. Setting HTTPS is performed by following the procedures below.

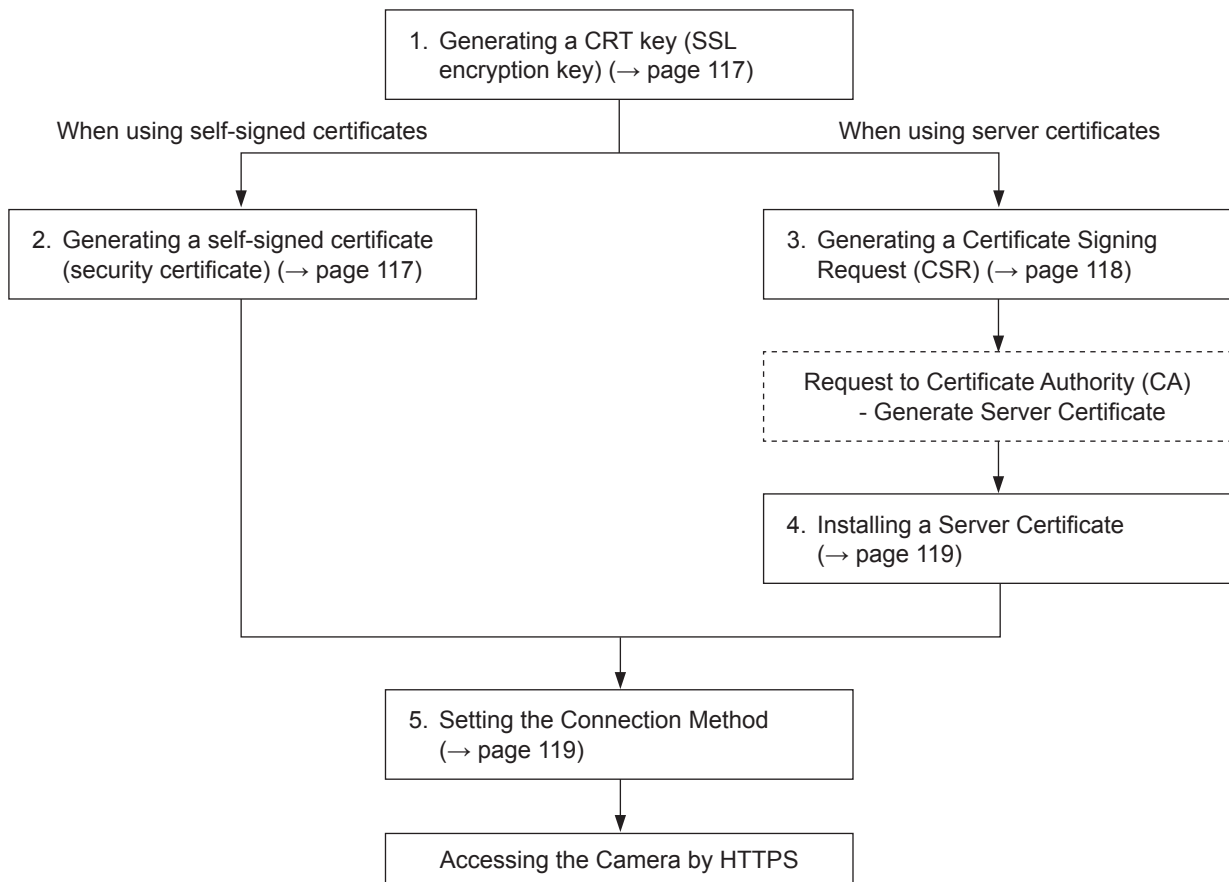
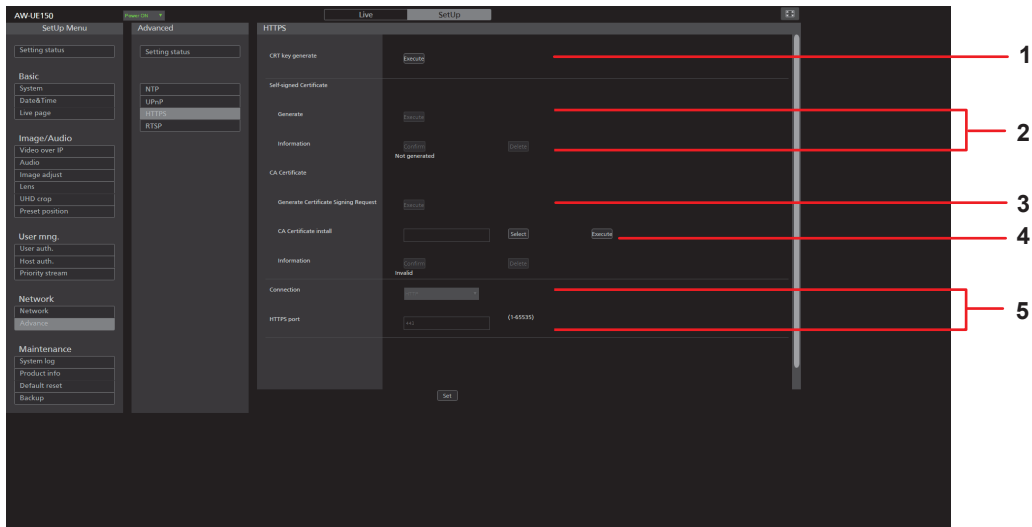

**<NOTE>**

- When using a server certificate, the process from applying to the Certificate Authority (CA) to issuing a server certificate must be performed between customers and the Certificate Authority (CA).
- Use either a self-signed certificate or server certificate. When simultaneously generating a self-signed certificate and installing a server certificate, this unit will prioritize the server certificate.

**■ Generating a CRT key (SSL encryption key)**  
**[CRT key generate]**

<NOTE>

- A CRT key cannot be generated when self-signed certificates and server certificates are enabled.
- The size of the key that can be used by the Certificate Authority (CA) differs when using a server certificate. Confirm in advance the size of the key that can be used.
- Generating a CRT key takes about 1 minute for 1024 bit and about 2 minutes for 2048 bit. Do not operate the web browser until CRT key generation is complete. Image display and communication speed may reduce while generating a CRT key.

**1. Click the [Execute] button in [CRT key generate].**

The [CRT key generate] dialog is displayed.

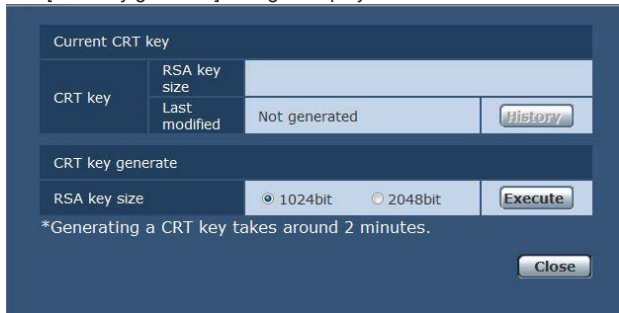

**2. The size of the generated CRT key is selected from [1024bit]/[2048bit] in [CRT key generate] – [RSA key size].**

<NOTE>

- When using a server certificate, the RSA key size must be in accordance with the demands of the Certificate Authority (CA) which will be applied to.

**3. Click the [Execute] button.**

CRT key generation starts.

When CRT key generation stops, the size of the CRT key generated by the [Current CRT key] and the date and time generation concluded will be displayed.

<NOTE>

- Perform procedures 1 to 3 to change (update) the generated CRT key. Because the CRT key, self-signed certificate and server certificate are enabled as a set, it will be necessary to once again generate a self-signed certificate or apply for a server certificate when the CRT key is changed.
- When the CRT key is changed, previous CRT keys are historically managed one at a time. Clicking the [Apply] button in the [Current CRT key] of the [CRT key generate] dialog displays the [Previous CRT key] dialog, allowing confirmation of the key size and the date and time generation was completed.

Clicking the [Apply] button in [Previous CRT key] allows the previous CRT key to be switched to the current CRT key.

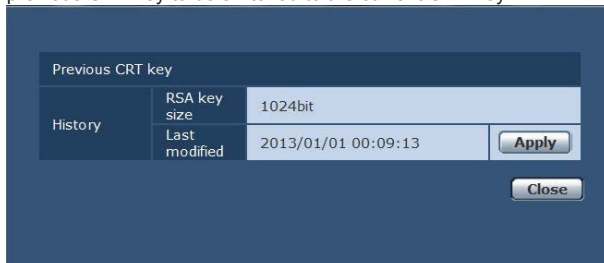

**■ Generating a self-signed certificate (security certificate)**

**[Self-signed Certificate - Generate]**

<NOTE>

- A self-signed certificate cannot be generated when a CRT key has not been generated.

**1. Click the [Execute] button in [Self-signed Certificate] - [Generate].**

[Self-signed Certificate - Generate] is displayed.

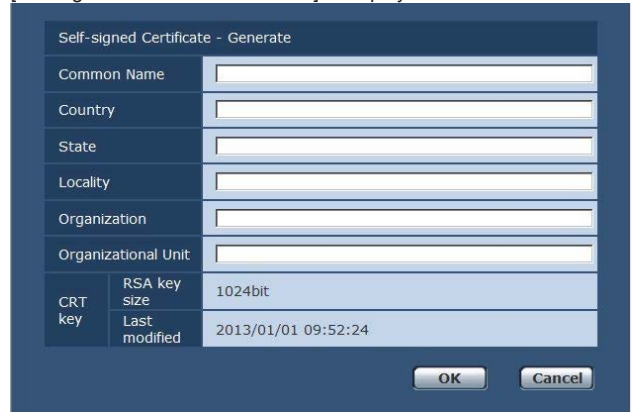

**2. Input information relating to the certificate to be generated.**

Items to be entered are as follows.

Item	Description	Maximum number of characters
Common Name	Inputs the camera address or host name.	64 characters
Country	Inputs the country code. (can be abbreviated)	2 characters: country code
State	Inputs the name of the state. (can be abbreviated)	128 characters
Locality	Inputs the name of the city. (can be abbreviated)	128 characters
Organization	Inputs the name of the organization. (can be abbreviated)	64 characters
Organizational Unit	Inputs the name of the organizational unit. (can be abbreviated)	64 characters
CRT key	Displays the size of the current CRT key and the date and time generation was completed.	

<NOTE>

- Characters that can be input for [Common Name], [Country], [State], [Locality], [Organization], [Organizational Unit] are 0 to 9, A to Z, a to z, and the following symbols: -, \_ , + / ( ).
- When connecting the camera to the Internet, set the address or host name to be accessed from the Internet in [Common Name]. In this case, when accessing the camera locally, a security warning screen is displayed every time the camera is accessed even when a security certificate is installed.
- When inputting the IPv6 address in [Common Name], surround the address with [ ].  
e.g. [2001:db8::10]

**3. Click the [OK] button after inputting the address.**

A self-signed certificate is generated.

**<NOTE>**

- Information relating to the generated self-signed certificate is displayed in [Self-signed Certificate] - [Information]. The following is displayed depending on the status of the self-signed security certificate.

Displayed content	Description
Not generated	When the self-signed certificate is not generated
Invalid (Reason: CA Certificate installed)	When the self-signed certificate is already generated and the server certificate is already installed <ul style="list-style-type: none"> <li>The server certificate is enabled in this case.</li> </ul>
[Common Name] of self-signed certificate	When the self-signed certificate is already generated and enabled

- When the [Confirm] button is clicked, the registered content of the generated self-signed certificate (security certificate) is displayed in the [Self-signed Certificate - Confirm] dialog.



- Click the [Delete] button to delete the generated self-signed certificate (security certificate).
- When [HTTPS] is selected in [Connection], the self-signed certificate (security certificate) cannot be deleted.

**■ Generating a Certificate Signing Request (CSR) [CA Certificate - Generate Certificate Signing Request]**

**<NOTE>**

- A certificate signing request (CSR) cannot be generated if a CRT key has not been generated.
- To generate a certificate signing request (CSR), perform the following settings in advance in the web browser Internet options. Perform the following settings in the [Security] tab (accessed from [Tools] in the menu bar - [Internet Options] - [Security]).
- Register the camera as a "Trusted Site".
- In [Level Customize], go to [File Download] from [Download] and set to [Enable].
- In [Level Customize], go to [Automatically Display Dialog when Downloading File] from [Download] and set to [Enable].

**1. Click the [Execute] button in [CA Certificate - Generate Certificate Signing Request].**

The [CA Certificate - Generate Certificate Signing Request] dialog is displayed.

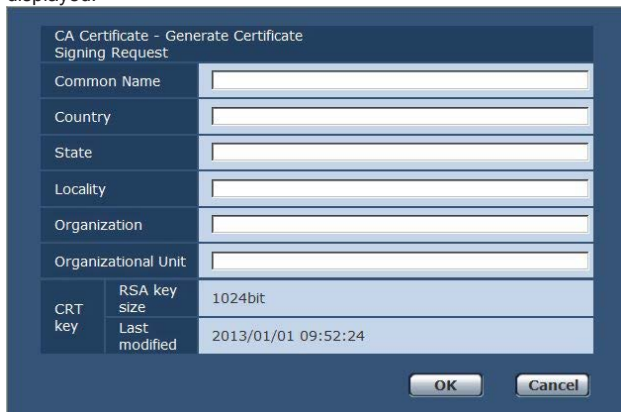

**2. Input information relating to the certificate to be generated.**

Items to be entered are as follows.

Item	Description	Maximum number of characters
Common Name	Inputs the camera address or host name.	64 characters
Country	Inputs the country code.	2 characters: country code
State	Inputs the name of the state.	128 characters
Locality	Inputs the name of the city.	128 characters
Organization	Inputs the name of the organization.	64 characters
Organizational Unit	Inputs the name of the organizational unit.	64 characters
CRT key	Displays the size of the current CRT key and the date and time generation was completed.	

**<NOTE>**

- When using a server certificate, the information to be input must be in accordance with the demands of the Certificate Authority (CA), which will be applied to.
- Characters that can be input for [Common Name], [Country], [State], [Locality], [Organization], [Organizational Unit] are 0 to 9, A to Z, a to z, and the following symbols: -, \_ , + / ( ).

**3. Click the [OK] button after inputting the address.**

The [Save As] dialog is displayed.

**4. In the [Save As] dialog, assign a file name to the Certificate Signing Request (CSR) and save it in personal computer.**

Apply to the Certificate Authority (CA) using the saved Certificate Signing Request (CSR).

**<NOTE>**

- A server certificate is issued for both the generated Certificate Signing Request (CSR) and CRT key. The issued server certificate can no longer be used when generating/updating the CRT key after applying to the Certificate Authority (CA).
- The Certificate Signing Request (CSR) generated by this unit is in a PEM format.

## ■ Installing a Server Certificate

### [CA Certificate - CA Certificate install]

<NOTE>

- A server certificate (security certificate) cannot be installed if a Certificate Signing Request (CSR) has not been generated.
- The server certificate must have been issued by the Certificate Authority (CA) in order to install it.

#### 1. Click the [Browse] button in [CA Certificate - CA Certificate install].

The [Open File] dialog is displayed.

#### 2. Select the server certificate file and click [Open]. Then click the [Execute] button.

The server certificate is installed.

<NOTE>

- The name of the host registered to the installed server certificate is displayed in [CA Certificate] - [Information]. The following is also displayed depending on the status of the server certificate.

Displayed content	Description
Invalid	When the server certificate is not installed
[Common Name] of server certificate	When the server certificate is already installed and enabled
Expired	When the effective period of the server certificate has expired

- When the [Confirm] button is clicked, the content of the installed server certificate (security certificate) is displayed in the [CA Certificate - Confirm] dialog. (An asterisk is displayed in the [Organizational Unit] field only.)



- Click the [Delete] button to delete the installed server certificate (security certificate).
- When [HTTPS] is selected in [Connection], the server certificate (security certificate) cannot be deleted.
- Perform STEP 1 to STEP 2 to update a server certificate.
- To delete an enabled server certificate (security certificate), confirm that there is a backup to the said certificate in your personal computer or recording media. A server certificate (security certificate) will be needed to reinstall it.
- The HTTPS function can no longer be used when the effective period of the server certificate has expired. In such a case, the connection method is changed to HTTP when the unit is restarted. Update the server certificate before its effective period expires.
- The effective period of the server certificate can be confirmed by double-clicking the server certificate file issued by the Certificate Authority (CA).

## ■ Setting the Connection Method

### [Connection]

#### 1. Set the method to access the camera in [Connection].

HTTP: Only HTTP connection is possible.

HTTPS: Only HTTPS connection is possible.

<NOTE>

- When using an HTTPS connection, network connection with the AW-RP120, AW-RP50, and AK-HRP200 will be disabled.

#### 2. Set the Port No. to be used with HTTPS in [HTTPS port].

Port No. that can be selected: 1 to 65535

The following port numbers are used by the unit so they cannot be used.

20, 21, 23, 25, 42, 53, 67, 68, 69, 80, 110, 123, 161, 162, 554, 995, 10669, 10670, 59000 to 61000

Factory settings: 443

#### 3. Click the [Set] button.

The camera restarts and access to the camera via HTTPS is enabled.

<NOTE>

- This unit will restart if the connection method is changed.
- **Using a self-signed certificate**  
A warning screen is displayed when accessing the camera by HTTPS for the first time. Install the self-signed certificate (security certificate) in your personal computer in accordance with the screen instructions. (→ page 120)
- **Using a server certificate**  
Install the Certificate Authority (CA) root certificate or intermediate certificate in your web browser in advance. Follow the Certificate Authority (CA) procedures to acquire and install root certificates and intermediate certificates.
- When accessing the camera by HTTPS, the image display speed and frame rate of the moving image may reduce.
- When accessing the camera by HTTPS, it may take some time for the images to be displayed.
- When accessing the camera by HTTPS, images may be disturbed and sound may be interrupted.
- The maximum number of cameras that can be connected simultaneously depends on the maximum image size and distribution format.

## ■ Accessing the Camera by HTTPS

#### 1. Launch the web browser in your personal computer.

#### 2. Input the camera's IP address in the address bar of the web browser.

Input address: https://192.168.0.10/

<NOTE>

- When the HTTPS port No. is changed from "443", input "https:// camera IP address: Port No." in the address bar.  
E.g. https://192.168.0.11:61443
- When this unit is in a local network, set a proxy server from the web browser (menu bar: [Tools] - [Internet Options]) to ensure that a proxy server is not used for a local address.

#### 3. Press the [Enter] key.

The live screen [Live] is displayed.

The security certificate is installed when the security warning screen is displayed. (→ page 120)

When [User auth.] is set to [On], the user name and password input screen is displayed before the live screen [Live] appears.

<NOTE>

- When HTTPS is used, screen and image display may slow down and image update interval (frame rate) may also slow down.

### ● Install the security certificate

When using HTTPS to access the camera, the security warning screen will be displayed if the security certificate of the said camera has not been installed in your personal computer. To prevent this warning screen being displayed, the security certificate must be installed in accordance with the following procedures. If it is not installed, the security warning screen will be displayed every time the camera is accessed.

#### <NOTE>

- The security certificate will be installed to your personal computer based on the content set for [Common Name]. The content set for the "Host Name" must therefore match that set for the address/host name used to access the camera. If the content differs, a security warning screen will be displayed every time the camera is accessed.
- A security warning screen will be displayed if the camera address/host name is changed even when a security certificate has been installed. Reinstall the security certificate.
- When connecting the camera to the Internet, set the address or host name to be accessed from the Internet in [Common Name]. In this case, when accessing the camera locally, a security warning screen is displayed every time the camera is accessed even when a security certificate is installed.
- When the security certificate is correctly installed, an icon of the key will be displayed in the address bar of the web browser accessing the camera. (in the case of Internet Explorer 8.0 and 9.0)
- The screen will differ partially in the case of Internet Explorer 10 and 11.

### 1. Accessing the Camera by HTTPS.

### 2. When the security warning screen is displayed, click [Continue to this website (not recommended)].

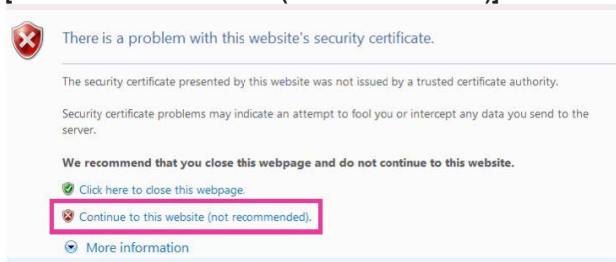

The live screen [Live] is displayed.

When the authentication screen is displayed, input the user name and password.

#### <NOTE>

- When the above screen is displayed after accessing a device apart from the camera or a website, there may be a security problem, so check this carefully.

### 3. Click [Certificate Error] in the URL and then click [View certificates].

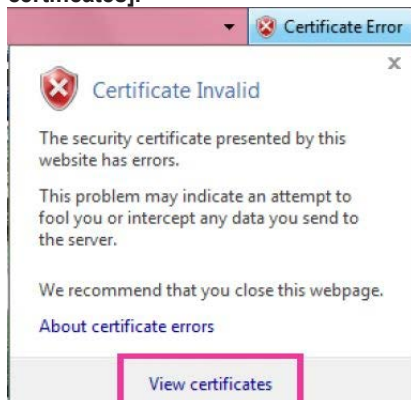

### 4. Click [Install Certificate...].

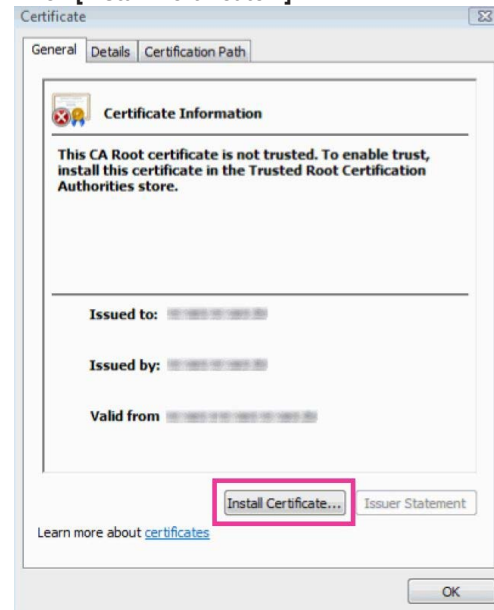

#### <NOTE>

- If [Install Certificate...] is not displayed, close Internet Explorer and restart it by selecting [Run as Administrator]. Right-click on [Start] - [Program] - [Internet Explorer] and click [Execute as Administrator (A)..].
- In the case of Windows 8 and 8.1, right-click on [ieexplore] under [C:\Program Files\Internet Explorer] and click [Execute as Administrator (A)..].

### 5. Click [Next], which is displayed in the certificate import wizard.

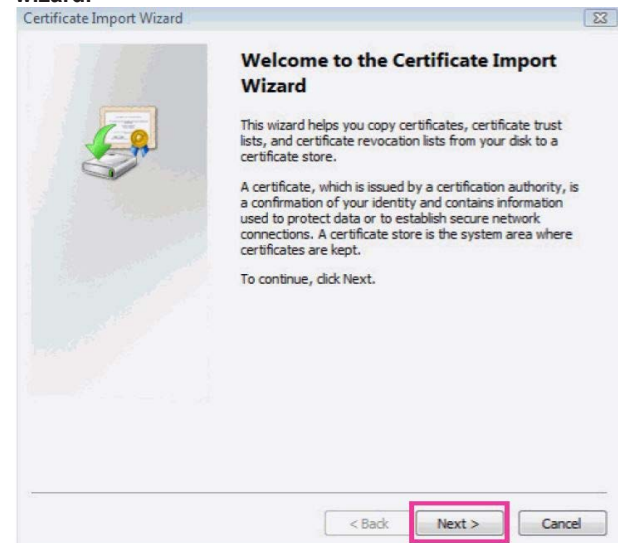

#### <NOTE>

- In the case of Internet Explorer 10 and 11, select the [Save destination] and click [Next].



6. Select [Place all certificates in the following store] and click [Browse...].

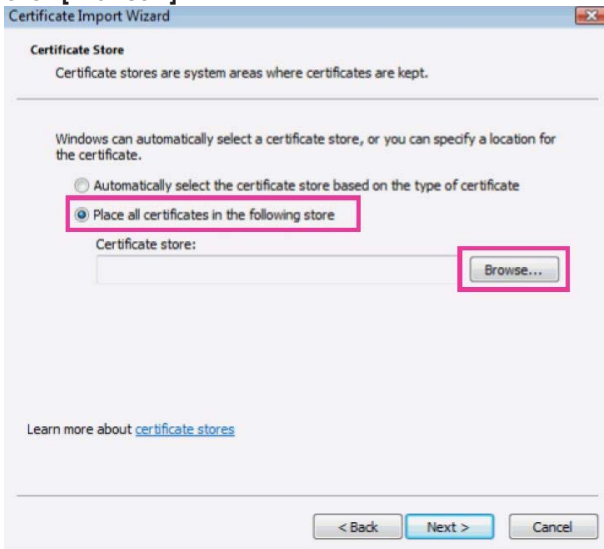

7. Select [Trusted Root Certification Authorities] and click [OK].

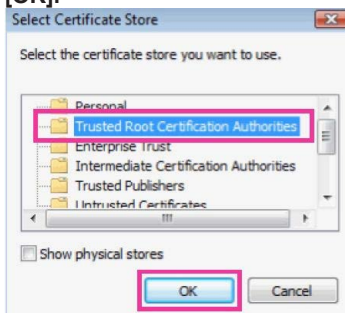

8. Click [Next].

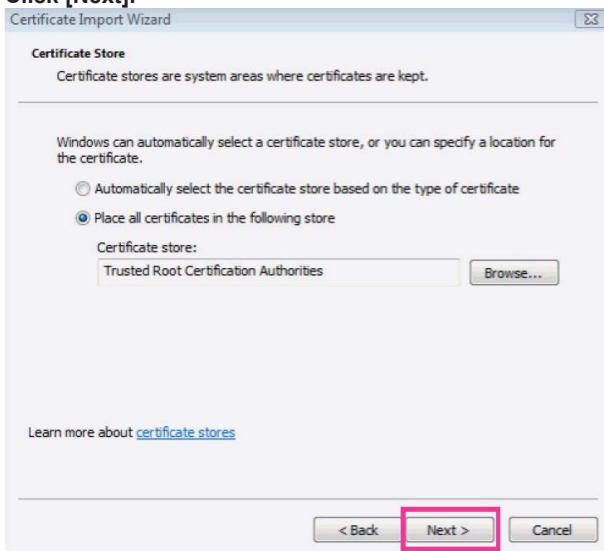

9. Click [Finish].

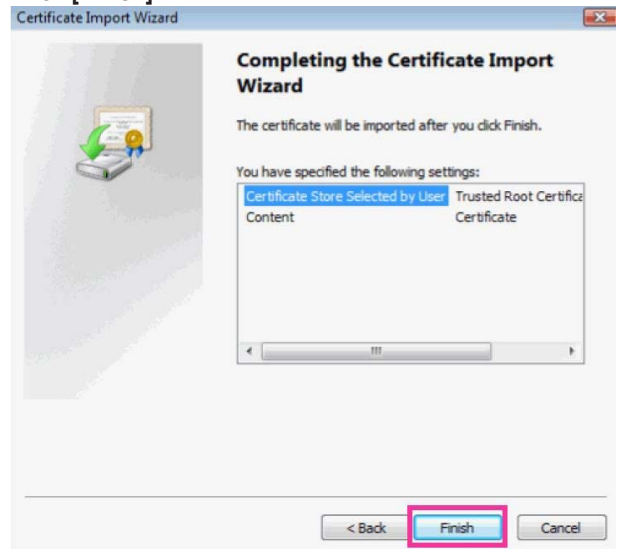

10. Click [Yes].

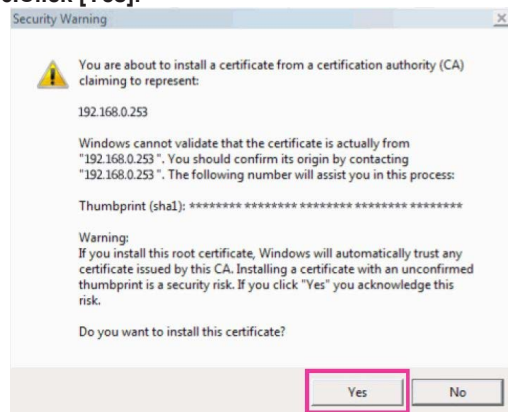

When importing is finished, the "Certificate was imported correctly" screen is displayed.

11. Click [OK].

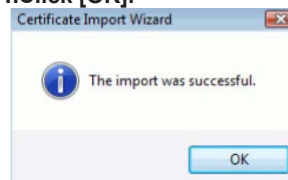

Closing the web browser after importing the certificate and reconnecting to it will stop the "Certificate error" screen being displayed.

### Maintenance screen [Maintenance]

Among the various maintenance operations performed on this screen are system log checks, system version upgrading and initialization of the unit.

The Maintenance screen consists of five tabs: [System log], [Product info.], [Status], [Default reset] and [Back up].

### System log screen [System log]

A maximum of 30000 system logs can be stored in the unit's internal memory.

When this maximum number has been exceeded, the old logs are overwritten successively by the new logs.

The logs are cleared when the unit's power is turned off.

#### <NOTE>

- The maximum number of entries that can be checked on the system log screen is 100. Entries beyond 100 can be checked by obtaining the log using CGI commands.

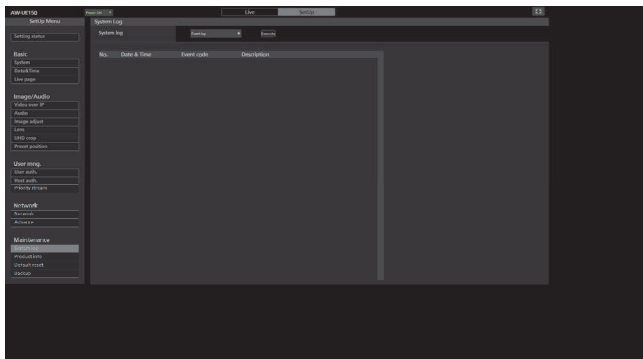

#### No.

The running numbers of the system logs are displayed here.

#### Time & date

The times and dates when the logs were generated are displayed here.

The 24-hour system is used to display this information.

#### Description

Details of the system logs are displayed here.

For further details on the system logs, refer to page 129.

### Product information screen [Product info.]

The versions of the unit's software can be checked on this screen.

The [Model no.], [MAC address], [Serial no.], [Firmware version] and other information about the unit is displayed.

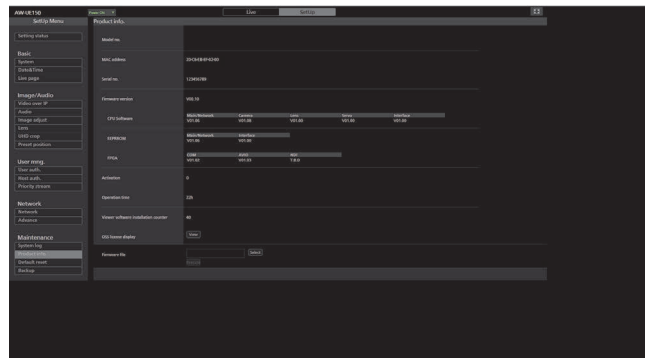

#### Model no.

Display the unit's model number.

#### MAC address

Display the unit's MAC address.

#### Serial no.

Display the unit's serial number.

#### Firmware version

##### CPU Software - Interface

Display the software version of the interface.

##### CPU Software - Camera Main

Display the software version of the camera unit.

##### CPU Software - Servo

Display the software version of the servo.

##### CPU Software - Network

Display the software version of the network.

##### EEPROM - Interface

Display the version of the setup data for the interface.

##### FPGA - Lens

Display the FPGA version of the lens.

##### FPGA - AVIO

Display the FPGA version of the AVIO.

##### FPGA - Com

Display the FPGA version of the communication.

#### Activation

Display information on the activated function.

#### Viewer software installation counter

The number of plug-in viewer software applications which have been installed automatically from the unit is displayed by this counter.

#### Firmware file

Update the firmware.

For details on how to update, see "Updating the firmware" (→ page 123).

#### Status

Display the current status of the unit.

### ● Updating the firmware

Perform the following to update the firmware.

#### 1. After consulting with your dealer, download the latest software to the hard disk of your personal computer.

##### <NOTE>

- No spaces or full-size characters can be used for the directory in which the software will be stored.
- Keep the maximum combined number of characters to be used for the name of the directory in which the software will be stored and for the name of the software which has been downloaded to less than 250 characters.

#### 2. Click the [Browse] button, and specify the downloaded software.

#### 3. Click the [Execute] button.

The software upgrade check screen is displayed.

After upgrading the software version, be absolutely sure to delete the temporary Internet files.

##### <NOTE>

- Be absolutely sure to upgrade the software versions from the personal computer in the same network (LAN) as the unit whose firmware version is to be updated.

##### <NOTE>

- After the [Execute] button is pressed, the amount of time it takes for the version upgrade progress bar to appear is about 1 minute for the Camera Main software or about 3 minutes for the Network software or AVIO FPGA. The progress bar will appear within 1 minute for other firmware.
- Use the personal computer on the same subnet as the camera to upgrade the software version.
- Before using the version upgrading software, be absolutely sure to check the precautions to be observed with your dealer, and follow the dealer's instructions.
- Use the following files specified by Panasonic Corporation as the software used for version upgrading.

CPU Software Interface	.sif files
CPU Software Camera Main	.scm files
CPU Software Servo	.spt files
CPU Software Network	.snw files
EEPROM Interface	.eep files
FPGA Lens	.fls files
FPGA AVIO	.fav files

- Do not turn off the unit's power while upgrading a software version. (Do not turn off the power until the progress bar display is cleared.)
- While a software version is being upgraded, do not attempt to execute any other operations until the version has been upgraded.

### ■ Reset settings screen [Default reset]

The unit's setting data is initialized and the unit is restarted on this screen.

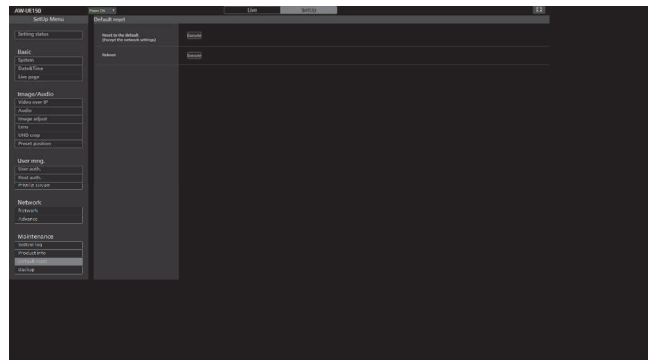

#### Reset to the default (Except the network settings)

When the [Execute] button is clicked, the unit's settings are returned to their defaults.

The login user name and password will also return to their defaults (admin/12345).

When the initialization operation is started, no operations can be undertaken for about 3 minutes.

##### <NOTE>

- The following setting items will not be returned to defaults.
  - All settings under [IPv4 network]
  - All settings under [IPv6 network]
  - [HTTP port]
  - [HTTPS - Connection]
  - [HTTPS - HTTPS port]
  - HTTPS: CRT key, server certificate
  - All settings under [UPnP]
  - [Line speed]
  - [Bandwidth control(bit rate)]
- [AWB] and [ABB] adjustment values will not be returned to defaults.

#### Reboot

When the [Execute] button is clicked, the unit is rebooted.

After the unit has been rebooted, no operations can be undertaken for about 2 minutes as is the case when the unit's power is turned on.

### ■ Back up screen [Back up]

On this screen, the unit's settings can be saved to a personal computer or settings saved in a personal computer can be loaded into the unit for use.

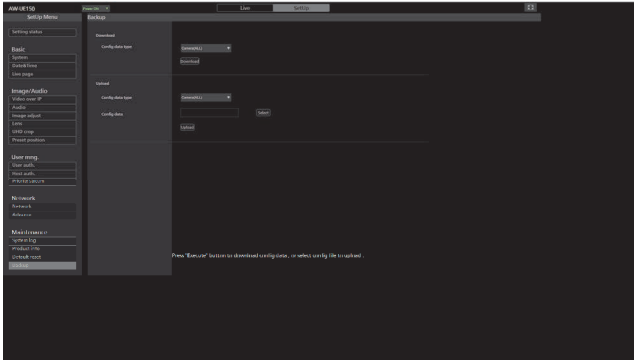

### Config data type

Specify the type of settings to save when saving the unit's configuration data on the personal computer.

**Setting value:**

Camera	Camera settings
Network	Network settings

### Download

Save the unit's settings onto the personal computer.

When the destination dialog box appears after clicking the [Execute] button, specify the destination folder.

When [Camera] is selected in [Config data type], the following settings are saved.

- Scene Scene1 settings
- Scene Scene2 settings
- Scene Scene3 settings
- Scene Scene4 settings
- System settings
- Preset settings

#### <NOTE>

- After the [Execute] button is clicked, the amount of time it takes for the destination dialog box to appear is about 10 seconds for a camera settings file and about 20 seconds for a network settings file.

### Upload

The unit's setting files, which were saved in the personal computer by the download function, are uploaded.

Click the [Browse] button to display the dialog box, and specify the saved file.

When you click the [OK] button in the message dialog box that appears after you click the [Execute] button, uploading starts.

Another message dialog box appears after uploading is complete.

When you click the [OK] button, the unit will restart automatically.

#### <NOTE>

- Use the files downloaded by the unit as the data to be used for uploading.  
Do not change the extension of the files (.cdt/.ndt) which have been downloaded.
- Do not turn off the unit's power while downloading or uploading is underway.
- Do not attempt to perform any operations while downloading or uploading is underway. Instead, wait until the downloading or uploading is completed.
- It takes about 2 minutes for the upload complete dialog box to appear for camera settings files.

# Displaying the web screen using a mobile terminal

Connect the mobile terminal to the unit, and display the unit's images (MJPEG format only). Refreshing to the latest images takes place automatically.  
 Operations such as panning, tilting and zooming can also be performed from the mobile terminal.  
 The following models are supported as mobile terminals. (as of November 2018).

Mobile terminal	Specifications
iPad iPhone iPod touch	iOS 7.1
Android™ terminals	Android 4.3

**<NOTE>**

- For the latest information on compatible operating systems and web browsers, visit the support desk at the following website.  
<https://pro-av.panasonic.net/>
- Use a standard web browser with an Android terminal.
- Images are displayed only in the JPEG format when using the standard web browser of an Android terminal.
- When the authentication dialog box is displayed, input the user name and password.

The default settings for the user name and password are as follows.

User name	admin
Password	12345

In order to ensure security, the password for the user name of "admin" must be changed without fail. (→ page 108)

- The buttons listed below are not displayed when "On" has been selected as the "User auth." (→ page 107) setting and "3. Live only" has been selected as the access level setting.
- Pan/Tilt
- Zoom
- Preset
- Iris
- Focus
- Camera menu (OSD menu) operation
- If the mobile terminal does not support the character code UTF-8, the characters cannot be displayed properly.
- When multiple Android terminals are connected to the unit at the same time, operation may become unstable.

**1. Input "http://IP address/mobile/" \*1 using the mobile terminal, and press the enter button.**

The unit's images will now be displayed.

\*1 This IP address is the global IP address for the WAN of the router that enables internet access. However, it is the local IP address if the unit in the same LAN is to be accessed using a mobile terminal which supports a wireless connection.

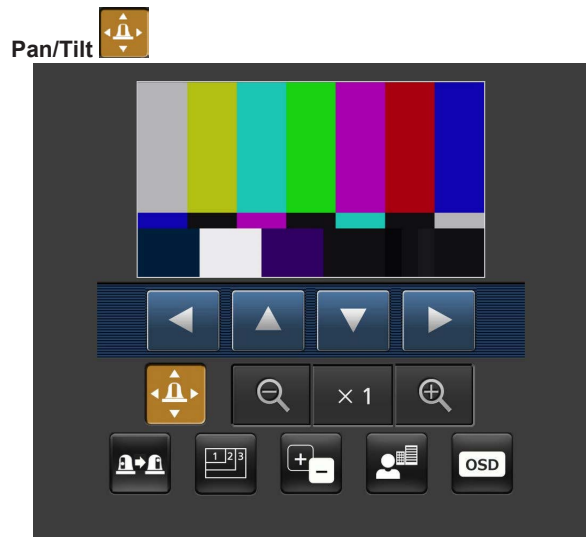

When this button is pressed, the buttons for performing the pan/tilt operations are displayed on the screen.

	The camera is panned toward the left.
	The camera is tilted upward.
	The camera is tilted downward.
	The camera is panned toward the right.

**<NOTE>**

- The camera will not move diagonally even when the pan button and tilt buttons are pressed at the same time. (The button pressed first takes precedence.)

**Zoom**

The unit's zooming operations are performed using these buttons.

	Use this to adjust the zoom (magnification) in the Wide direction.
	Use this to adjust the zoom (magnification) to 1.0x.
	Use this to adjust the zoom (magnification) in the Tele direction.

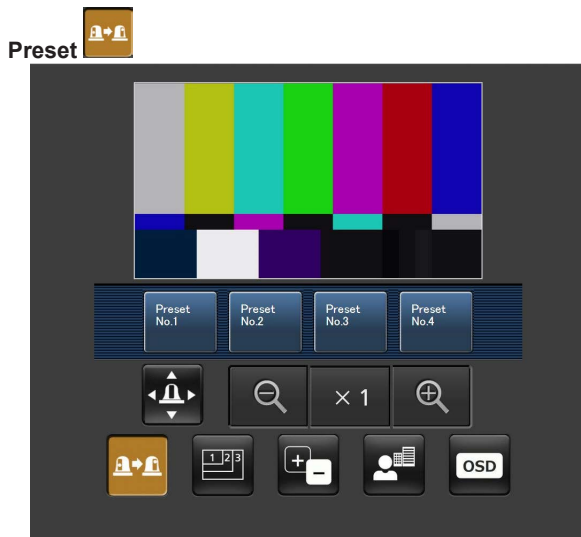

When this button is pressed, the buttons for selecting the preset positions are displayed on the screen.

	When one of the displayed buttons is pressed, the camera's pan/tilt position moves to the preset position that was registered ahead of time. The settings that are reproduced at this position are the settings which were established on the [Preset Scope] menu (→ page 61, page 88, page 106).

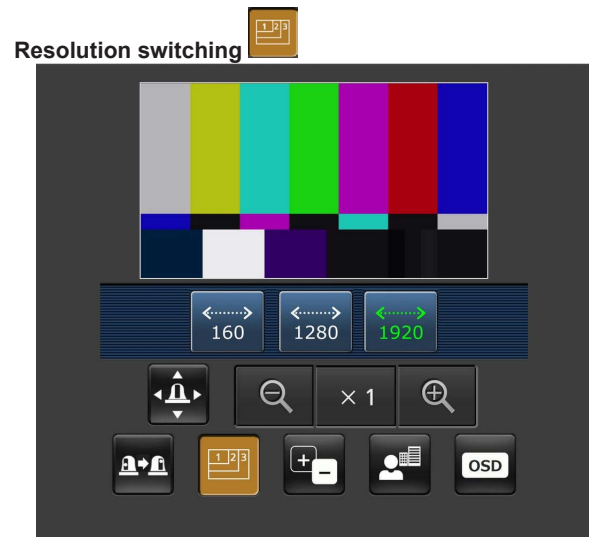

When this button is pressed, the buttons for selecting the resolution are displayed on the screen.

The characters are displayed in green for the resolution button which is currently selected.

The resolution configured with [JPEG(1)], [JPEG(2)], and [JPEG(3)] in the [Video over IP] tab is displayed.



	The images are displayed with a resolution of 1920 x 1080 pixels.
	The images are displayed with a resolution of 1280 x 720 pixels.
	The images are displayed with a resolution of 640 x 360 pixels.
	The images are displayed with a resolution of 320 x 180 pixels.
	The images are displayed with a resolution of 160 x 90 pixels.

### <NOTE>

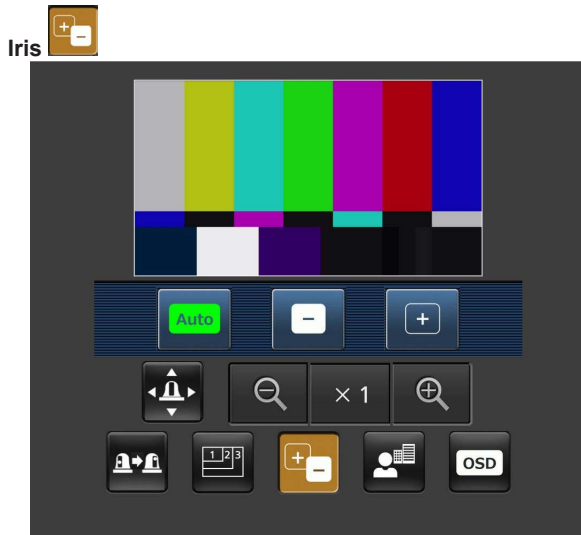
- Depending on the resolution set for [JPEG(1)], [JPEG(2)], and [JPEG(3)], resolution switching may not be possible.





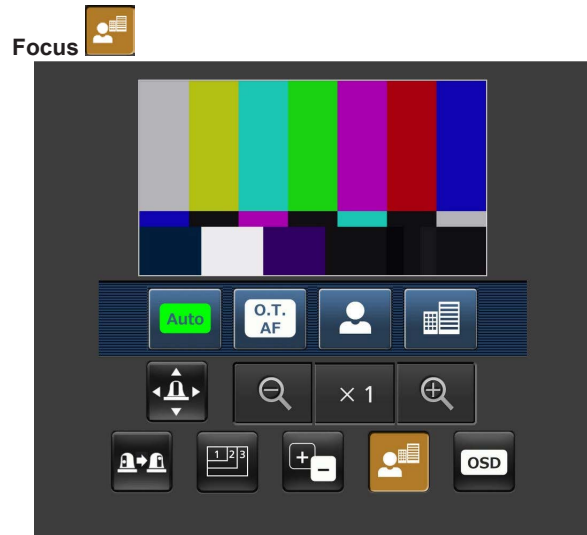

When this button is pressed, the buttons for performing the iris operations are displayed on the screen.

	This switches the iris between auto and manual. At the auto setting, the button label is green.
	This adjusts the iris in the “close” direction. It does not work during automatic adjustments.
	This adjusts the iris in the “open” direction. It does not work during automatic adjustments.







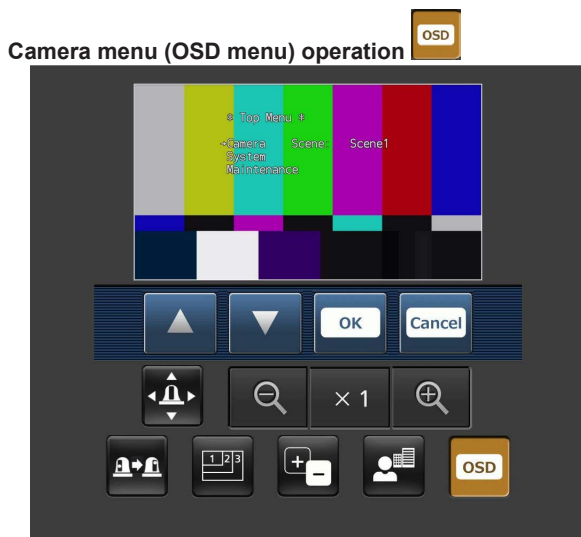



When this button is pressed, the buttons for performing the focusing operations are displayed on the screen.

	Use this to switch between auto and manual focusing. At the auto setting, focusing is performed (the focal point is adjusted) automatically. At the auto setting, the button label turns green.
	When this is pressed while the focus is being adjusted manually, the focus will be temporarily adjusted automatically. It does not work during automatic adjustments.
	Use this to adjust the focus in the “near” direction. It does not work during automatic adjustments.
	Use this to adjust the focus in the “far” direction. It does not work during automatic adjustments.



When this button is pressed, the buttons for performing the camera menu operations are displayed on the screen.

At the same time, the camera menus are displayed on the unit's images.

	<p>The unit's camera menu operations can be performed by pressing the , ,  and  buttons.</p> <p>When any of these buttons is pressed to switch to an operation that does not involve a camera menu, the camera menus are no longer displayed on the unit's images.</p> <p>For details of the camera menu, refer to page 66.</p>
	
	
	

### Tally lamp lighting status displays

The lighting status of the camera's tally lamp is monitored at regular intervals while the camera is connected, and the lamp's display is updated.

While the tally lamp is on, the IP video display area frame turns red. When the tally lamp is off, the display area will return to normal.

#### <NOTE>

- It may take 2 seconds or so for a change in the lighting status of the tally lamp to be reflected on the display of the mobile terminal.
- When [Disable] is selected for [Tally] (→ page 59, page 89), the camera's tally lamp will not light even when the tally signal is input. However, the tally lamp lighting status display will turn red.

#### <NOTE>

- If the HTTP port number has been changed from "80", enter "http://<IP address>:<port number>/mobile/"\*1 to specify the unit's port number.
- When [HTTPS] - [Connection] (→ page 115) is set to [HTTPS] in the [Advanced] tab of the Network setup screen [Network], enter the following.  
https://<IP address port number>/mobile
- When the authentication dialog box appears, enter the user name and password of an administrator or general user.  
Depending on the mobile terminal, password entry may be required when transitioning between each screen.
- Audio cannot be received on mobile terminals.
- If the [User auth.] (→ page 107) setting has been changed to [On] from a personal computer while the mobile terminal screen is displayed, it may not be possible to refresh the mobile terminal screen. In a case like this, first close the web browser which is running on the mobile terminal, and then open the mobile terminal screen again.
- If the images are large, it may not be possible to display them on some mobile terminals. In such cases, displaying the images may be possible if a value closer to the lowest image quality is selected for [Image quality] (→ page 92) in [JPEG].
- Access may not be possible depending on your mobile terminal and device plans.
- If, when using an Android terminal, more than one button is pressed at the same time, one of the buttons may remain pressed even after it has been released. At a time like this, press again only that button that has remained pressed to release it.

Example) When the pan (left) button and pan (right) button are pressed at the same time, either the pan (left) button or pan (right) button will remain pressed, and panning will continue.

→ When the pan (left) button or pan (right) button that has remained pressed is pressed again, the panning will stop.

\*1 This IP address is the global IP address for the WAN of the router that enables internet access. However, it is the local IP address if the unit in the same LAN is to be accessed using a mobile terminal which supports a wireless connection.



# System log displays

## NTP-related error displays

Category	Display	Description
Connection error	No response from the NTP server.	<ul style="list-style-type: none"><li>The IP address of the server may be incorrect. Check the server's IP address settings again.</li><li>The NTP server may be down. Consult your server administrator.</li></ul>
Internal error	Undefined error.	<ul style="list-style-type: none"><li>A problem has occurred in the NTP function. Check the NTP settings again.</li></ul>
Successful NTP-based time synchronization	NTP update succeeded.	<ul style="list-style-type: none"><li>The time has been updated successfully.</li></ul>

## HTTPS-related log displays

Category	Display	Description
HTTPS	Self-signed Certificate - Generated	<ul style="list-style-type: none"><li>Generation of the self-signed certificate is complete.</li></ul>
	Self-signed Certificate - Deleted	<ul style="list-style-type: none"><li>Deletion of the self-signed certificate is complete.</li></ul>
	Certificate Signing Request - Generated	<ul style="list-style-type: none"><li>Generation of the certificate signing request is complete.</li></ul>
	CA Certificate - Installed	<ul style="list-style-type: none"><li>Installation of the server certificate is complete.</li></ul>
	CA Certificate - Deleted	<ul style="list-style-type: none"><li>Deletion of the server certificate is complete.</li></ul>
	Previous CRT key - Applied	<ul style="list-style-type: none"><li>The previous CRT key has been applied as the CRT key.</li></ul>
	CRT key - Generated	<ul style="list-style-type: none"><li>Generation of the CRT key is complete.</li></ul>

## Login-related displays

Category	Display	Description
Login	(User name or IP address)	<ul style="list-style-type: none"><li>If user authorization has been set, the name of the user who has logged onto the unit is displayed.</li><li>If host authorization has been set, the IP address of the user who has logged onto the unit is displayed.</li></ul>

## Displays related to access commands

Category	Display	Description
Image transmission demand	jpeg ch [No.] Play [User name] and [IP address]	<ul style="list-style-type: none"><li>Displays the user name and IP address of the user that logged into this unit and made a JPEG transmission play demand.</li></ul>
	jpeg Stop [User name] and [IP address]	<ul style="list-style-type: none"><li>Displays the user name and IP address of the user that logged into this unit and made a JPEG transmission stop demand.</li></ul>
	mjpeg ch [No.] Play [User name] and [IP address]	<ul style="list-style-type: none"><li>Displays the user name and IP address of the user that logged into this unit and made a MJPEG transmission play demand.</li></ul>
	h264 ch [No.] Play [User name] and [IP address]	<ul style="list-style-type: none"><li>Displays the user name and IP address of the user that logged into this unit and made a h264 transmission play demand.</li></ul>
	h264 ch [No.] Stop [User name] and [IP address]	<ul style="list-style-type: none"><li>Displays the user name and IP address of the user that logged into this unit and made a h264 transmission stop demand.</li></ul>
Audio transmission demand	audio Play [User name] and [IP address]	<ul style="list-style-type: none"><li>Displays the user name and IP address of the user that logged into this unit and made an audio transmission play demand.</li></ul>
	audio Stop [User name] and [IP address]	<ul style="list-style-type: none"><li>Displays the user name and IP address of the user that logged into this unit and made an audio transmission stop demand.</li></ul>
Other CGI commands	[CGI command], [User name] and [IP address]	<ul style="list-style-type: none"><li>Displays the user name and IP address of the user that logged into this unit and ran a specific CGI command. However, not all CGI commands are displayed each time they are executed.</li></ul>



## Limiters

---

This unit comes with settings (referred to as “limiters”) that restrict the panning and tilting movement ranges.

Depending on the installation location, obstacles that may come into contact with the remote camera may exist within its movement range. In such cases, setting the limiters before the obstacles will prevent contact.

The positions of four limiters — namely, the upper, lower, leftmost and right-most limits of the travel range — can be set. Once they have been set, the positions will not be lost even after the power has been turned off.

The limiters can be set or released both by the wireless remote control and controller or web setting screen [Setup]. Whatever was set or released last takes precedence. For the controller operations, refer to the Operating Instructions of the controller.

The settings of the limiters using the wireless remote control will be described here.

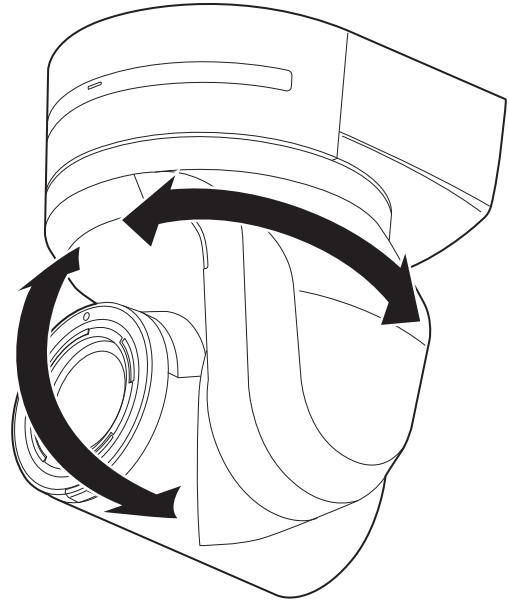

# Setting/releasing the limiters

## Basic limiter operations

### 1. Press the <MENU> button.

Tap the button (rather than pressing it). When it is pressed for 2 seconds, the camera menu will appear. If this happens, press the <MENU> button again for 2 seconds to clear the camera menu.

Then start again from step 1.

### 2. Press the <▲/▼/◀/▶> button for 2 seconds while holding down the <PRESET> button.

The limiter for the upper limit, lower limit, left limit or right limit is set (or released) using these direction buttons, respectively. The tally lamp will blink at this time. When a limiter is set, it blinks once; when a limiter is released, it blinks twice.

If any other button was operated between steps 1 and 2, start again from step 1.

## Setting the limiters

The limiter positions can be set by following the steps below. When the position is set, the tally lamp blinks once.

### 1. Press one of the <CAM1> to <CAM4> button to select the unit.

#### • Setting the upper limit position of the movement range

Press the <▲> or <▼> button of the wireless remote control to turn the unit as far as the position which will serve as the upper limit.

Next, perform the steps in “Basic limiter operations”. (Press the <MENU> button quickly and then press the <▲> button for 2 seconds while holding down the <PRESET> button.)

#### • Setting the lower limit position of the movement range

Press the <▲> or <▼> button of the wireless remote control to turn the unit as far as the position which will serve as the lower limit.

Next, perform the steps in “Basic limiter operations”. (Press the <MENU> button quickly and then press the <▼> button for 2 seconds while holding down the <PRESET> button.)

#### • Setting the left-most limit position of the movement range

Press the <◀> or <▶> button of the wireless remote control to turn the unit as far as the position which will serve as the left-most limit.

Next, perform the steps in “Basic limiter operations”. (Press the <MENU> button quickly and then press the <◀> button for 2 seconds while holding down the <PRESET> button.)

#### • Setting the right-most limit position of the movement range

Press the <◀> or <▶> button of the wireless remote control to turn the unit as far as the position which will serve as the right-most limit.

Next, perform the steps in “Basic limiter operations”. (Press the <MENU> button quickly and then press the <▶> button for 2 seconds while holding down the <PRESET> button.)

## Releasing the limiters

The limiter positions that are set can be released by following the steps below.

When the position is released, the tally lamp blinks twice.

### 1. Press one of the <CAM1> to <CAM4> button to select the unit.

### 2. Release the limiters by taking the steps below.

#### • Releasing the upper limit position of the movement range

Perform the steps in “Basic limiter operations”. (Press the <MENU> button quickly and then press the <▲> button for 2 seconds while holding down the <PRESET> button.)

#### • Releasing the lower limit position of the movement range

Perform the steps in “Basic limiter operations”. (Press the <MENU> button quickly and then press the <▼> button for 2 seconds while holding down the <PRESET> button.)

#### • Releasing the left-most limit position of the movement range

Perform the steps in “Basic limiter operations”. (Press the <MENU> button quickly and then press the <◀> button for 2 seconds while holding down the <PRESET> button.)

#### • Releasing the right-most limit position of the movement range

Perform the steps in “Basic limiter operations”. (Press the <MENU> button quickly and then press the <▶> button for 2 seconds while holding down the <PRESET> button.)

## Resetting the limiters

To reset the limiters, the currently established settings must be released. The limiter positions that are set can be reset by following the steps below.

### 1. Release the settings of the limiter positions to be reset by following the steps in “Releasing the limiters”.

### 2. Set the limiter positions by following the steps in “Setting the limiters”.

## Safe mode

---

### Concerning the safe mode

The unit goes into the safe mode when the pan-tilt head is forcibly moved by an external force or when something impedes its rotation. Once the safe mode has been established, some or all of the operations will no longer be acknowledged to ensure safety and prevent equipment damage.

### Detection of equipment trouble

When the unit has detected trouble, its functions are shut down, then the unit is restarted or the initial setting operation is performed, and the normal condition of the unit is restored after about 30 seconds.

#### <NOTE>

- When trouble is detected, pictures may no longer be output for a while, but they will be restored in 5 seconds to 10 seconds.

# Troubleshooting

## ■ Operation

Symptom	Cause and solution	Reference pages
No power	<ul style="list-style-type: none"> <li>Is the AC cable of the external DC power supply securely connected to the AC outlet?</li> </ul>	---
	<ul style="list-style-type: none"> <li>If the power plug of the external DC power supply connected properly?</li> </ul>	---
	<ul style="list-style-type: none"> <li>Is the LAN cable connected securely to the IP control LAN connector &lt;LAN LINK/ACT&gt;?</li> </ul>	page 17
	<ul style="list-style-type: none"> <li>Is the network cable for the PoE++ (IEEE802.3bt) compatible power supply device and the unit connected properly?</li> </ul>	Installation Instructions
	<ul style="list-style-type: none"> <li>Power may not be supplied if the total power limit is exceeded on power supply devices that allow connections to multiple PoE++ terminals. → Refer to the operating instructions for the PoE++ power supply device.</li> </ul>	---
	<ul style="list-style-type: none"> <li>If the unit is connected to the controller, has it been connected properly? → Refer to the operating instructions for the controller.</li> </ul>	Installation Instructions
	<ul style="list-style-type: none"> <li>When performing operations from a wireless remote control → Also refer to the "Cannot operate using the wireless remote control" item.</li> </ul>	---
Cannot operate (common to wireless remote control, controller)	<ul style="list-style-type: none"> <li>Is the power on? → If the unit's status display lamp is off or lights up orange, it means that the unit's power is not on.</li> </ul>	page 29
	<ul style="list-style-type: none"> <li>The safe mode function may have been activated.</li> </ul>	page 133
	<ul style="list-style-type: none"> <li>Have the limiter functions been set?</li> </ul>	pages 131 to 132
	<ul style="list-style-type: none"> <li>Has the unit you want to operate been selected properly?</li> </ul>	page 30
Cannot operate using the wireless remote control	<ul style="list-style-type: none"> <li>Have the remote control's batteries run down or have the batteries been installed with their polarities reversed? → If the status display lamp does not blink even when the wireless remote control is operated near the wireless remote control signal light-sensing area, it means that the batteries have run down. Replace the batteries.</li> </ul>	---
	<ul style="list-style-type: none"> <li>Have the IR ID switches been set correctly?</li> </ul>	page 19, page 26
	<ul style="list-style-type: none"> <li>Is there a fluorescent light or plasma monitor near the unit and, if so, is the wireless remote control signal light-sensing area exposed to its light?</li> </ul>	page 16
Cannot operate using the controller	<ul style="list-style-type: none"> <li>Is the unit connected to the controller properly? → Refer to the operating instructions for the controller.</li> </ul>	Installation Instructions
	<ul style="list-style-type: none"> <li>The user authorization and host authorization must be set to OFF when the AW-RP150 remote camera controller is connected in a network.</li> </ul>	page 107, page 108
	<ul style="list-style-type: none"> <li>It may be necessary to upgrade the version of the controller so that the controller will support the unit. → For details on upgrading, visit the support page on the following website. <a href="https://pro-av.panasonic.net/">https://pro-av.panasonic.net/</a></li> </ul>	---
The unit turns in the opposite direction to the one operated	<ul style="list-style-type: none"> <li>Has the stand-alone (Desktop) installation setting been selected correctly?</li> </ul>	page 60, page 88
	<ul style="list-style-type: none"> <li>The reversal setting may have been established at the controller if the unit is connected to the controller. → Refer to the operating instructions for the controller.</li> </ul>	---

## Troubleshooting (continued)

Symptom	Cause and solution	Reference pages
Cannot access from a web browser	<ul style="list-style-type: none"> <li>• <b>Has a LAN cable of category 5e or above been connected to the LAN connector for IP control &lt;LAN LINK/ACT&gt;?</b></li> </ul>	Installation Instructions
	<ul style="list-style-type: none"> <li>• <b>Is the [LINK] LED of the LAN connector for IP control lit?</b> → If it is not lit, it means that something is wrong with the connection to the LAN or that the network at the connection destination is not working properly. Check the LAN cable for defective contacts, and check the wiring.</li> </ul>	Installation Instructions
	<ul style="list-style-type: none"> <li>• <b>Is the power on?</b> → If the unit's status display lamp is off or lights up orange, it means that the unit's power is not on.</li> </ul>	page 29
	<ul style="list-style-type: none"> <li>• <b>Has a valid IP address been set in the unit?</b></li> </ul>	page 109
	<ul style="list-style-type: none"> <li>• <b>Has the wrong IP address been accessed?</b> → Check the connections by following the steps below. <b>For Windows:</b> Using the Windows command prompt, execute &gt; ping [IP address which has been set in the camera] A reply returned from the unit signifies that there are no problems in operation. If a reply is not received, try following operation: • Reboot the unit, and within 20 minutes change the IP address using the Easy IP Setup Software. <b>For Mac:</b> Using the OS X terminal, execute &gt; ping -c 10 [IP address which has been set in the camera] A reply returned from the unit signifies that there are no problems in operation. If a reply is not received, try following operation: • Reboot the unit, and within 20 minutes change the IP address using the Easy IP Setup Software.</li> </ul>	---
	<ul style="list-style-type: none"> <li>• <b>Are you accessing via "http://" while the HTTPS function is enabled?</b> → Perform access via "https://" when using the HTTPS function. Entry of the port number is also required.</li> </ul>	page 119
	<ul style="list-style-type: none"> <li>• <b>Is the same IP address setting being used by another unit?</b> → Check out the IP addresses of the unit, access devices (personal computer, mobile terminal, controller, etc.) and any other cameras.</li> </ul>	page 64
	<ul style="list-style-type: none"> <li>• <b>Does the subnet mask setting match the network subnet of the connection destination?</b> → Check out the subnet mask settings of the unit and access devices, and then consult with the network administrator.</li> </ul>	page 64
	<ul style="list-style-type: none"> <li>• <b>Has the "Use a proxy server" setting been selected by the web browser? (When the unit and the personal computer are connected to the same subnet)</b> → If a proxy server has been set using the [proxy setting] of the web browser, it is recommended that a "Don't use proxy" address be selected as the unit's IP address setting.</li> </ul>	---
<ul style="list-style-type: none"> <li>• <b>Has the wrong default gateway been set for the unit? (When the unit and personal computer are connected to different subnets)</b> → Check out the default gateway that has been set for the unit, and then consult with the network administrator.</li> </ul>	page 64	

## Troubleshooting (continued)

Symptom	Cause and solution	Reference pages
The settings on the web setting screen [Setup] are not updated or displayed properly	<b>For Windows:</b> <ul style="list-style-type: none"> <li>• Press the [F5] key on the keyboard of the personal computer to request that the settings be acquired.</li> </ul> <b>For Mac:</b> <ul style="list-style-type: none"> <li>• Press the [Command] + [R] key on the personal computer's keyboard to request that the settings be acquired.</li> </ul>	---
	<ul style="list-style-type: none"> <li>• Perform the following to delete the temporary Internet files.</li> </ul> <b>For Windows:</b> <ol style="list-style-type: none"> <li>① Select [Tools] - [Internet Options] in Internet Explorer.</li> <li>② Click the [General] tab, and click the [Delete] button under [Browsing history].</li> <li>③ In the [Delete Browsing History] screen, select the [Temporary Internet Files] checkbox, and then click [Delete].</li> <li>④ Click the [OK] button.</li> </ol> <b>For Mac:</b> <ol style="list-style-type: none"> <li>① Select [Safari] - [Empty Cache] in Safari.</li> <li>② Click [Empty] in the [Are you sure you want to empty the cache?] pop-up screen.</li> </ol>	---
	<b>For Windows:</b> <ul style="list-style-type: none"> <li>• If [Check for newer versions of stored pages] is not set to [Every time I visit the webpage] in the temporary Internet file settings, IP images may not appear in the web setting screen.</li> </ul> → Perform the following. <ol style="list-style-type: none"> <li>① Select [Tools] - [Internet Options] in Internet Explorer.</li> <li>② Click the [General] tab, and click the [Settings] button under [Browsing history].</li> <li>③ In the [Temporary Internet Files and History Settings] dialog box, select the [Every time I visit the webpage] option under [Check for newer versions of stored pages].</li> <li>④ Click the [OK] button.</li> </ol>	---
	<ul style="list-style-type: none"> <li>• The unit's ports may be filtered by the firewall or other function of the anti-virus software.</li> </ul> → Change the HTTP port number of the unit to a port number that will not be filtered.	---
It is not possible to download the setting files	<b>For Windows:</b> <ul style="list-style-type: none"> <li>• Has the file download function been disabled?</li> </ul> → Perform the following. <ol style="list-style-type: none"> <li>① Select [Tools] - [Internet Options] in Internet Explorer.</li> <li>② Click the [Security] tab, and click the [Custom level] button under [Security level for this zone].</li> <li>③ In the [Security Settings] dialog box, select the [Enable] option for [File download].</li> <li>④ Click the [OK] button.</li> <li>⑤ Click the [OK] button.</li> </ol>	---
The tally lamps do not light	<ul style="list-style-type: none"> <li>• Is the [Tally] setting set to [Disable]?</li> </ul> → If [Tally] is set to [Disable], the unit's tally lamp does not light. Change the setting to [Enable].	page 59, page 89
Status display lamp does not light	<ul style="list-style-type: none"> <li>• Is the [Status Lamp] setting set to [Disable]?</li> </ul> → If [Status Lamp] is set to [Disable], the status display lamp does not light when this unit is working properly. Change the setting to [Enable].	page 59, page 89
Commands from the personal computer, external devices, and remote controller are unstable	<ul style="list-style-type: none"> <li>• Are two or more Android terminals connected?</li> </ul> → Only one Android terminal can be connected to the unit.	---
The authentication screen appears repeatedly	<ul style="list-style-type: none"> <li>• Has the user name or password been changed?</li> </ul> → If you change the user name and password of the user currently logged in from a separate web browser while the unit is being accessed, the authentication screen appears each time the screen display is changed. Close the web browser, and initiate access to the unit again.	page 107, page 108
	<ul style="list-style-type: none"> <li>• Has the method for user authentication been changed?</li> </ul> → If you change the [User auth.] - [Authentication] setting, close the web browser and initiate access again.	page 107



## Troubleshooting (continued)

Symptom	Cause and solution	Reference pages
Screens displays take a while to appear	<ul style="list-style-type: none"> <li>• <b>Is access being performed in HTTPS mode?</b> Screen displays may take a while to appear in HTTPS mode due to signal processing.</li> </ul>	---
	<ul style="list-style-type: none"> <li>• <b>Is the unit on the same local network and being accessed via proxy?</b> → Configure the web browser settings so that access is not performed via proxy.</li> </ul>	---
	<ul style="list-style-type: none"> <li>• <b>Are multiple users accessing the unit's IP images at the same time?</b> → When multiple users access the unit's IP images at the same time, images may take some time to appear, and the frame rate of the IP images may drop.</li> </ul>	---
Cannot access the camera from a mobile terminal	<ul style="list-style-type: none"> <li>• <b>Is the URL correct? Has "/mobile" been entered at the end of the URL?</b> → Check whether the URL has been entered correctly. When accessing the unit from a mobile terminal, "/mobile" must be added to the end of the URL used to access the unit from a personal computer.</li> </ul>	page 125
	<ul style="list-style-type: none"> <li>• <b>Is the HTTPS SSL encryption of the mobile terminal different from that of the unit?</b> → Set [HTTPS] - [Connection] for the unit to [HTTP], and initiate access again.</li> </ul>	page 115
	<ul style="list-style-type: none"> <li>• <b>Are you accessing via "http://" while using the HTTPS function?</b> → When using the HTTPS function, access via "https://". Port number entry is also necessary.</li> </ul>	page 128
The shortcut icon of the camera does not appear under [Network] on the personal computer	<ul style="list-style-type: none"> <li>• <b>Has the Windows UPnP component been added?</b> → Add the Windows UPnP component to the personal computer you are using.</li> </ul>	page 113

■ Video

Symptom	Cause and solution	Reference pages
No pictures are displayed or the pictures are disturbed	• Has the unit been connected properly to the other connected devices?	Installation Instructions
	• If the system is configured in such a way that the picture is also switched when the unit to be operated is selected, has the correct unit been selected?	page 30
	• Has the image signal setting been selected correctly?	page 54, page 87
	• Are external sync signals that are supported by the video signal format which has been set being input?	page 19
The picture is flipped vertically	• Has the stand-alone (Desktop) installation setting been selected correctly?	page 60, page 88
Multiple color bands (color bars) are displayed	• Switch to the camera picture.	page 33
The menu screen is displayed	• Exit the camera menu.	page 41
It is difficult to view the menu screens	<ul style="list-style-type: none"> <li>• Depending on the HDMI monitor you are using, you may experience one or more of the symptoms described below. These symptoms are especially noticeable when any of the SD formats is used: This is normal and not indicative of any trouble.</li> <li>• The resolution of the characters in the camera menu displays changes as the background image changes.</li> <li>• Depending on the edge enhancement setting established for the monitor, white lines appear in front of the black shadows of the camera menus.</li> <li>• Depending on the edge enhancement setting established for the monitor, the background colors may be superimposed onto the white parts of the camera menus.</li> </ul>	---
No auto focusing	<ul style="list-style-type: none"> <li>• Is the focus set to manual? → Auto focusing is initiated as soon as the focus is set to auto.</li> </ul>	page 33
	<ul style="list-style-type: none"> <li>• In some situations, it may be hard to focus at the auto setting. → In cases like this, select the manual setting, and focus manually.</li> </ul>	page 34
The subject is not brought into focus during zooming when the manual setting is used for the focus	<ul style="list-style-type: none"> <li>• Was the focus adjusted at the Tele end? → First adjust the focus at the Tele end where the focusing accuracy is higher, and then proceed with the zooming.</li> </ul>	---
	<ul style="list-style-type: none"> <li>• Under some operating conditions, it may be hard to bring subjects into focus. → In such cases, use the focus at the auto setting.</li> </ul>	page 33
Focusing is not possible in night mode	<ul style="list-style-type: none"> <li>• Are you shooting with visible light? → The focus position is different due to the difference in refractive index between visible light and infrared light. Wavelengths near 900 nm are assumed for infrared light in night mode on this unit. Perform manual adjustment if necessary.</li> </ul>	page 34
2160/59.94p images are not output	<ul style="list-style-type: none"> <li>• xxxxxxxxxxxxxx? → xxxxxxxxxxxxxxxxxxxx</li> </ul>	page 54, page 88
1080/50p images are not output	<ul style="list-style-type: none"> <li>• Is the format set to 50p? → Configure the format setting.</li> </ul>	page 54, page 88
1080/29.97PsF images appear jerky	<ul style="list-style-type: none"> <li>• This is normal operation. → In the PsF (Progressive segmented Frame) format, an identical image is captured to fields 1 and 2 in order to output the same image as progressive. Therefore, the image will appear slightly jerky.</li> </ul>	---
1080/25PsF images appear jerky	<ul style="list-style-type: none"> <li>• This is normal operation. → In the PsF (Progressive segmented Frame) format, an identical image is captured to fields 1 and 2 in order to output the same image as progressive. Therefore, the image will appear slightly jerky.</li> </ul>	---

## Troubleshooting (continued)

Symptom	Cause and solution	Reference pages
Something is wrong with the coloring of the pictures	<ul style="list-style-type: none"> <li>• Activate the ATW (Auto tracking white adjustment) function.</li> </ul>	page 37
	<ul style="list-style-type: none"> <li>• In some situations, the proper colors may not be reproduced using the ATW function. → In cases like this, proceed with the white balance adjustment.</li> </ul>	pages 36 to 37
The pictures are too light or too dark	<ul style="list-style-type: none"> <li>• Either select the auto setting for the iris or select the manual setting and adjust the iris manually.</li> </ul>	page 34
	<ul style="list-style-type: none"> <li>• The pictures may be dark if the analog video signal cables are too long because this will cause signal attenuation.</li> </ul>	---
Images are in black and white	<ul style="list-style-type: none"> <li>• Is the unit in night mode? → In night mode, output will be in black and white.</li> </ul>	page 45, page 98
Auto white balance adjustment (AWB) is not possible	<ul style="list-style-type: none"> <li>• Is the unit in night mode? → Auto white balance adjustment (AWB) is not possible in night mode.</li> </ul>	page 45, page 98
The screen is too bright in night mode	<ul style="list-style-type: none"> <li>• The aperture is set to open in night mode to prevent video voyeurism. Adjust the brightness at the light source.</li> </ul>	page 34
The iris does not operate in night mode.		
The subjects appear distorted	<ul style="list-style-type: none"> <li>• Since this camera uses an MOS imaging device, the pickup timing differs slightly at the top left and bottom right of the screen. This means that if a subject moves quickly across the front of the camera, it may appear slightly distorted. This is not a malfunction.</li> </ul>	---
When the flash is fired during shooting, only the top or bottom of the screen becomes lighter	<ul style="list-style-type: none"> <li>• With a MOS imaging sensor, the pickup timing differs slightly at the top left and bottom right of the screen. This means that when the flash is fired, the bottom of the screen will become lighter in the field concerned and the top will become lighter in the next field. This is normal and not indicative of any problem.</li> </ul>	---
The brightness changes cyclically or the colors change, and horizontal stripes can be seen passing across the screen	<ul style="list-style-type: none"> <li>• These phenomena (flicker) may occur under the illumination produced by fluorescent lighting, mercury bulbs or other types of discharge tubes. In such cases, we recommend setting the electronic shutter speed to 1/100 in regions with 50 Hz power supply frequency, and to OFF in regions with 60 Hz power supply frequency.</li> </ul>	---
When fine lines or cyclical patterns are shot, flickering is seen or coloring is added to them	<ul style="list-style-type: none"> <li>• This phenomenon occurs because the pixels are arranged systematically on each image sensor. It is noticeable when the spatial frequency of a subject and the pixel pitch are brought into proximity so change the camera angle or take other action.</li> </ul>	---
Noise occurs in the audio input	<ul style="list-style-type: none"> <li>• The following causes are possible. <ul style="list-style-type: none"> <li>- The camera, switching hub, or peripheral devices are not grounded.</li> <li>- Power lines are running nearby.</li> <li>- Equipment generating strong electric or magnetic fields (e.g., television and radio antennas, air conditioning motors, power transformers) are located nearby.</li> </ul> </li> </ul> <p>If the problem cannot be resolved via movement of surrounding devices, use a microphone equipped with an amplifier, or connect an audio output with low output impedance.</p>	page 7

■ IP images

Symptom	Cause and solution	Reference pages
Images are not displayed	<b>For Windows:</b> <ul style="list-style-type: none"> <li>• <b>Is the plug-in viewer software installed?</b> → Install the plug-in viewer software.</li> </ul>	page 28
	<b>For Windows:</b> <ul style="list-style-type: none"> <li>• <b>If [Check for newer versions of stored pages] is not set to [Every time I visit the webpage] in the temporary Internet file settings, IP images may not appear in the live screen [Live].</b> → Perform the following.                             <ol style="list-style-type: none"> <li>① Select [Tools] - [Internet Options] in Internet Explorer.</li> <li>② Click the [General] tab, and click the [Settings] button under [Browsing history].</li> <li>③ In the [Temporary Internet Files and History Settings] dialog box, select the [Every time I visit the webpage] option under [Check for newer versions of stored pages].</li> <li>④ Click the [OK] button.</li> </ol> </li> </ul>	---
The images are blurry	<ul style="list-style-type: none"> <li>• <b>Is the focus properly adjusted?</b> → Check the focus adjustment.</li> </ul>	---
Images are not updated	<ul style="list-style-type: none"> <li>• <b>The images may not be updated and other problems may occur depending on your web browser and its version.</b></li> <li>• <b>The images may stop depending on the network congestion, the level of access to the unit, etc.</b></li> <li>• <b>If the IP video settings of the unit were changed, the image display may stop temporarily.</b> → Check the level of access to the unit, and stop any unnecessary access. Afterward, check the following.                             <ul style="list-style-type: none"> <li><b>For Windows:</b> Press the [F5] key on the personal computer's keyboard to request that the settings be acquired.</li> <li><b>For Mac:</b> Press the [Command] + [R] key on the personal computer's keyboard to request that the settings be acquired.</li> <li><b>For mobile terminals:</b> Refresh the screen by pressing the [Refresh] button on the web browser, for example, to request that the settings be acquired.</li> </ul> </li> </ul>	---
The images do not update or display properly	<ul style="list-style-type: none"> <li>• <b>Perform the following to delete the temporary Internet files.</b> <ul style="list-style-type: none"> <li><b>For Windows:</b> <ol style="list-style-type: none"> <li>① Select [Tools] - [Internet Options] in Internet Explorer.</li> <li>② Click the [General] tab, and click the [Delete] button under [Browsing history].</li> <li>③ In the [Delete Browsing History] screen, select the [Temporary Internet Files] checkbox, and then click [Delete].</li> <li>④ Click the [OK] button.</li> </ol> </li> <li><b>For Mac:</b> <ol style="list-style-type: none"> <li>① Select [Safari] - [Empty Cache] in Safari.</li> <li>② Click [Empty] in the [Are you sure you want to empty the cache?] pop-up screen.</li> </ol> </li> </ul> </li> </ul>	---
	<ul style="list-style-type: none"> <li>• <b>Reconfigure Wi-Fi settings as follows.</b> <ul style="list-style-type: none"> <li><b>For mobile terminals (iOS):</b> Execute [Reset Network Settings] in [Settings] icon - [General] - [Reset], and configure new Wi-Fi settings.</li> </ul> </li> </ul>	---
	<ul style="list-style-type: none"> <li>• <b>The unit's ports may be filtered by the firewall or other function of the anti-virus software.</b> → Change the HTTP port number of the unit to a port number that will not be filtered.</li> </ul>	---
H.264 images are not displayed	<ul style="list-style-type: none"> <li>• <b>If the "Network Camera View 4S" plug-in viewer software is deleted in an environment where the "Network Camera View 3" plug-in viewer software is installed, display of H.264 images will become impossible. In such cases, delete "Network Camera View 3" before installing "Network Camera View 4S".</b></li> </ul>	---
	<ul style="list-style-type: none"> <li>• <b>Is the camera connected to the personal computer via the Internet?</b> → Set [Internet mode(over HTTP)] to [On].</li> </ul>	page 92

## Troubleshooting (continued)

Symptom	Cause and solution	Reference pages
The images are distorted	<ul style="list-style-type: none"> <li>• The images may be distorted if the transmission path is congested and proper transmission is not possible. → Consult your network administrator.</li> </ul>	---
	<ul style="list-style-type: none"> <li>• The images may be distorted if video packet shuffling occurs on the transmission path. → Switching to an identical Internet service provider for both the camera and the personal computer may prevent this problem. Consult your network administrator.</li> </ul>	---
The images darken when the mobile terminal is not operated for a certain period	<ul style="list-style-type: none"> <li>• Is the power-saving mode of the mobile terminal enabled? → Disable the power-saving mode of the mobile terminal to allow the images to be displayed indefinitely.</li> </ul>	---
When multiple web browsers are running to display H.264 images, images from multiple cameras appear sequentially in a single web browser	<p><b>For Windows:</b></p> <ul style="list-style-type: none"> <li>• This may occur depending on the combination of the personal computer's display adaptor and the driver. → If this occurs, update the first display adaptor to the latest version. If this does not resolve the problem, adjust the hardware accelerator function as follows. This section describes the procedure for Windows 7 as an example. Changing the settings may not be possible, depending on your environment. ① Right-click on the desktop, and select [Screen Resolution] from the menu. ② Click [Advanced settings]. ③ Select the [Troubleshoot] tab, and click [Change setting]. ④ If the [User Account Control] dialog box appears, click [Yes]. (When logged on with an account other than an administrator account, enter the password (and user name if necessary), and click [Yes].) ⑤ Change to [Hardware acceleration] setting to [None] at the far left, and click [OK].</li> </ul>	---
Images are not displayed for NDI HX-compatible switchers	<ul style="list-style-type: none"> <li>• The setting values in the [Video over IP] IP video settings screen may have been changed. → Set [Parameter Setting] &gt; [Parameter] to [NDI HX] to reset the setting values in [Video over IP].</li> </ul>	pages 92 to 94
	<ul style="list-style-type: none"> <li>• The [RTSP] &gt; [RTSP port] and [RTSP Request URL (1)] to [RTSP Request URL (4)] setting values in the [Advanced] advanced network setting screen may have been changed. → Reset the settings to their factory default values.</li> </ul>	page 115
	<ul style="list-style-type: none"> <li>• [User auth.] may be set to [On] in the [User auth.] user authentication screen. → Reset the setting to [Off].</li> </ul>	page 107
Audio is not output for NDI HX-compatible switchers	<ul style="list-style-type: none"> <li>• [Audio] may be set to [Off] in the [Audio] audio screen. → Reset the setting to [On].</li> </ul>	page 96

## Troubleshooting (continued)

### ■ Web screen

Depending on the OS installed on the personal computer, the following may occur. Follow the instructions below when the following has occurred. Performing the following solutions will not affect the operation of other applications.

#### For Windows:

The "information bar" described in the following explanations refers to the message bars that appear in Internet Explorer 11.0. The information bar appears at the bottom of Internet Explorer.



Symptom	Cause and solution	Reference pages
The following message appears in the information bar. "This website wants to run the following add-on: 'WebVideo Module' from 'Panasonic System Networks Co., Ltd.'"	<ul style="list-style-type: none"> <li>Select [Allow].</li> </ul>	---
The following message appears in the information bar. "This website wants to install the following add-on: 'nwcV4SSetup.exe' from 'Panasonic System Networks Co., Ltd.'"	<ul style="list-style-type: none"> <li>Select [Install]. When the security warning window appears, click the [Install] button.</li> </ul>	---
An unnecessary status bar or scroll bar is displayed on the pop-up window	<ul style="list-style-type: none"> <li>Open the security settings screen for Internet Explorer, and select [Internet]. Click the [Custom level] button, set [Allow script-initiated windows without size or position constraints] to [Enable] under [Miscellaneous], and click the [OK] button. When the warning window appears, click the [Yes] button.</li> </ul>	---
The IP images do not match the display frames	<ul style="list-style-type: none"> <li>Images may not appear correctly if their DPI settings are 120 DPI or higher. → Right-click on the desktop of the personal computer, click [Screen Resolution] - [Make text and other items larger or smaller], and select [Smaller - 100% (default)].</li> </ul>	---
	<ul style="list-style-type: none"> <li>Images may not appear correctly if the magnification level of Internet Explorer's zoom function is not set to 100%. → Select [View] - [Zoom] in the menu bar of Internet Explorer, and click [100%].</li> </ul>	---
The layout of the screen is distorted, or some buttons on the screen do not operate	<ul style="list-style-type: none"> <li>Select [Tools] - [Compatibility View Settings] in the menu bar of Internet Explorer, disable compatibility view for the unit.</li> </ul>	---

# Specifications

**Power requirements:** 12 V DC  $\pm 10\%$  (10.8 V to 13.2 V)  
42 V to 57 V DC  $\pm 10\%$  (PoE++ power supply)  
**Current consumption:** xxxx A (XLR IN connector)  
xxxx A (PoE++ power supply)

 indicates safety information.

## ■ GENERAL

### Ambient operating temperature:

0 °C to 40 °C (32 °F to 104 °F)

### Storage temperature:

-20 °C to 50 °C (-4 °F to 122 °F)

### Ambient operating humidity:

20% to 90% (no condensation)

### Mass:

Approx. 3.9 kg (8.60 lb) (Including mount bracket)

### Dimensions (W × H × D):

213 mm × 267 mm × 219 mm  
(8.39 inches × 10.51 inches × 8.62 inches)  
(excluding protrusions, direct ceiling mount bracket)

### Finish:

AW-UE150WP/AW-UE150WE: Pearl white  
AW-UE150KP/AW-UE150KE: Metallic black

### Controller supported:

AW-RP150, AW-RP120\*, AW-RP50\*, AK-HRP200\*  
\* It may be necessary to upgrade the version of the controller in order to support the unit. For details on upgrading, visit the support page on the following website.  
<https://pro-av.panasonic.net/>  
\* New features specific to this unit may not work. (Operation requires use of OSD)

## ■ INPUT

### Input connector:

DC 12 V IN,  
G/L IN (BNC)  
• BBS (Black Burst Sync), tri-level sync supported

## ■ OUTPUT

### Video output

### HDMI:

HDMI 2.0 connector  
Supported bit: xxxx bit  
Sampling rate: xxxx  
• HDCP is not supported.  
• Viera Link is not supported.

### UHD OUT:

SMPTE 2082-1 standard/75 Ω (BNC×1)

### HD/SDI OUT:

SMPTE292/75 Ω (BNC×1)  
• Level-A/Level-B supported

### MONI OUT:

SMPTE292/75 Ω (BNC×1)

### Fiber:

Single Fiber  
• SDI signal converted to optical signal

## ■ INPUT/OUTPUT

### Input/Output connector

### LAN:

LAN connector for IP control (RJ-45)  
• Cross cable

### RS-422:

CONTROL IN RS-422A (RJ-45)

### MIC/LINE input:

∅ 3.5 mm stereo mini jack  
Input impedance: High impedance  
• During MIC input  
Supported mic: Stereo mic (plug-in power, on/off switching via menu)  
Supply voltage: 2.5 V ± 0.5 V  
Mic input sensitivity: Approx. -40 dBV ± 3 dBV (0 dB=1 V/Pa, 1 kHz)  
• During LINE input  
Input level: Approx. -10 dBV ± 3 dBV

## ■ FUNCTIONS AND PERFORMANCE

### [Camera unit]

**Imaging sensors:** 1-type 4K MOS×1

### Lens:

Motorized Optical 20× zoom, F2.8 to F4.5  
(f=8.8 mm to 176.0 mm; 35 mm equivalent: 24.5 mm to 490.0 mm)  
Extender-Zoom 1.34×  
(when switching optical 20× zoom to iZoom)

**Conversion lens:** Not supported

### Angle of view range:

Horizontal angle of view: 76.2° (wide) to 4.3° (tele)  
Vertical angle of view: 47.6° (wide) to 2.4° (tele)  
Diagonal angle of view: 84.0° (wide) to 4.9° (tele)

### Optical filter:

Through, 1/4, 1/16, 1/64, IR through  
(IR through is used as "Night mode")

### Focus:

Switching between auto and manual

### Focus distance:

Entire zooming range: 1000 mm (xxxx ft)  
Wide end: 100 mm (xxxx ft)

### Color separation optical system:

1MOS

### Minimum illumination:

2 lx (50 IRE, F2.8, 36 dB, without accumulation)

### Horizontal resolution:

1600 TV lines Typ (Center area)

### Gain selection:

Auto, 0 dB to 42 dB (1 dB steps)

### Frame mix:

0 dB, 6 dB, 12 dB, 18 dB, 24 dB  
• This cannot be configured when the format is 2160/29.97p, 2160/23.98p, 2160/24p, 2160/25p, 1080/29.97p, 1080/23.98p(59.94i), 1080/29.97PsF, 1080/23.98PsF, 1080/25p, 1080/25PsF.

## Specifications (continued)

### Electronic shutter speed:

- 59.94p/59.94i mode  
1/60, 1/100, 1/120, 1/250, 1/500, 1/1000, 1/2000, 1/4000, 1/8000, 1/10000
- 29.97p mode  
1/30, 1/60, 1/100, 1/120, 1/250, 1/500, 1/1000, 1/2000, 1/4000, 1/8000, 1/10000
- 23.98p mode  
1/24, 1/48, 1/60, 1/100, 1/120, 1/250, 1/500, 1/1000, 1/2000, 1/4000, 1/8000, 1/10000
- 50p/50i mode  
1/60, 1/100, 1/120, 1/250, 1/500, 1/1000, 1/2000, 1/4000, 1/8000, 1/10000
- 25p mode  
1/25, 1/50, 1/60, 1/100, 1/120, 1/250, 1/500, 1/1000, 1/2000, 1/4000, 1/8000, 1/10000

### Synchro scan:

- 59.94p/59.94i mode  
60.00 Hz to 7200 Hz
- 29.97p mode  
30.00 Hz to 7200 Hz
- 23.98p mode  
24.00 Hz to 7200 Hz
- 50p/50i mode  
50.00 Hz to 7200 Hz
- 25p mode  
25.00 Hz to 7200 Hz

**Gamma:** HD/FILMLIKE1/FILMLIKE2/FILMLIKE3/  
FILM REC/VIDEO REC 0.30 to 0.75

**White balance:** ATW: 3200K, 5600K  
AWB: AWB-A/AWB-B  
VAR (selectable between 2000K and 15000K by designating a value)

**Chroma amount variability:**  
OFF, -99% to 99%

**Scene file:** Scene1, Scene2, Scene3, Scene4

### Output format UHD/FHD SDI:

**[4K format]** 2160/59.94p, 2160/50p, 2160/29.97p\*1, 2160/25p\*1, 2160/24p (Just), 2160/23.98p\*1

**[HD format]** 1080/59.94p, 1080/50p, 1080/59.94i, 1080/50i, 1080/29.97p\*1, 1080/23.98p\*2, 1080/25p\*1, 1080/29.97PsF, 1080/23.98PsF, 1080/25PsF, 1080/24p (Just), 1080/23.98p\*1, 720/59.94p\*3, 720/50p\*3

### UHD/FHD Fiber:

**[4K format]** 2160/59.94p, 2160/50p, 2160/29.97p\*1, 2160/25p\*1, 2160/24p (Just), 2160/23.98p\*1

**[HD format]** 1080/59.94p, 1080/50p, 1080/59.94i, 1080/50i, 1080/29.97p\*1, 1080/23.98p\*2, 1080/25p\*1, 1080/29.97PsF, 1080/23.98PsF, 1080/25PsF, 1080/24p (Just), 1080/23.98p\*1, 720/59.94p\*3, 720/50p\*3

\*1 Native output

\*2 OVER 59.94i output (your monitor may recognize the signal as 59.94i).

\*3 When 720/59.94p or 720/50p is selected, only 720p is output.

- When selecting formats for UHD SDI, HDMI, and Fiber, it is not possible to select different formats for each of them. Furthermore, the formats for FHD SDI and MONI OUT are fixed to the formatting method selected for UHD SDI and HDMI.

### Synchronization system:

Internal/External synchronization (BBS/Tri-level sync)

### [Pan-tilt head unit]

### Installation method:

- Stand-alone (Desktop) or suspended (Hanging)
- To ensure safety, the unit must be secured using the mount bracket supplied.

### Camera/pan-tilt head control:

<b>IP connecting cable</b>	<ul style="list-style-type: none"> <li>• When connecting through a PoE++ hub: LAN cable (category 5e or above, straight cable or cross cable), max. 100 m (328 ft)</li> <li>• When a PoE++ hub is not used: LAN cable (category 5 or above, straight cable) max. 100 m (328 ft)</li> </ul>
<b>AW protocol connecting cable</b>	LAN cable (category 5 or above, straight cable), max. 1000 m (3280 ft)

### Pan/tilt operation speed:

- Maximum speed 60°/s or higher
- Maximum speed is 180°/second or more when quietness and still precision are ignored.



**Panning range:** ±175°

**Tilting range:** -30° to 210°

- Depending on the pan or tilt position, the camera may be reflected in the image.

**Quietness:** NC35 or less

The symbols on this product (including the accessories) represent the following:

	AC
	DC
	Class II equipment (The construction of the product is double-insulated.)

Inrush current, measured according to European standard EN55103-1, on initial switch-on: 4 A, after a supply interruption of 5 s: 13 A



# Index

## Numerics

3G SDI .....	56, 58
3G SDI/IP Out .....	59
3G SDI Out .....	56
3G SDI OUT connector .....	18
12G SDI/FIBER .....	56, 58
12G SDI OUT connector .....	19
3200K .....	37
5600K .....	37

## A

ABB .....	99
Access level .....	108, 109
Accessories .....	13
Activation .....	109, 122
Advanced .....	113
AGC Max Gain .....	44, 97
ATW .....	37
ATW Speed .....	46
ATW Target B .....	46
ATW Target R .....	46
Audio .....	58, 96
Audio bit rate .....	96
Audio encoding format .....	96
AUDIO IN connector .....	19
Authentication .....	107
Auto Iris Speed .....	43
Auto Iris Window .....	43
Auto Knee Response .....	50
Automatic installation of viewer software .....	86
Auto port forwarding .....	114
AVIO .....	63
AWB .....	36, 99
AWB Gain Offset .....	45

## B

Back up .....	124
Bandwidth control (bit rate) .....	111
Bar .....	58
Basic .....	84
B Gain .....	45, 99
Black balance .....	38
Black Gamma .....	49
Black Gamma Range .....	49
Black level .....	39
B Pedestal .....	46, 99
Brightness .....	43, 44, 97, 104
Buffering .....	86
Burst tolerance level .....	93

## C

CA Certificate	
CA Certificate install .....	114, 119
Generate Certificate Signing Request .....	114, 118
Information .....	115
Camera .....	42, 43, 63
Camera head .....	17
Camera menu .....	42, 66, 128
Camera short cut .....	114
Camera title .....	85
Camera title display area .....	79
Chroma Level .....	46, 99
Chroma Phase .....	46
Color bar .....	76
Color Bars Setup .....	87
Color Bar Type .....	58
Color Correction .....	52, 53, 101
Color Temperature .....	45, 99
COM .....	63
Common .....	111
Compression .....	76
Config data type .....	124
Connected device indication .....	79

Connection .....	115, 119
Control pad and its buttons .....	78, 104
Control time period .....	93
CPU Software .....	63
Camera Main .....	122
Interface .....	122
Network .....	122
Servo .....	122
Crop Adjust .....	59
Crop H Position .....	60
Crop Marker .....	59
Crop Out .....	59
Crop V Position .....	60
CRT key generate .....	114, 117

## D

Day/Night .....	45, 98
DC. Detail Coring .....	48
DC. Detail Frequency .....	48
DC IN connector .....	19
DC. Knee Aperture Level .....	48
DC. Level Depend. .....	48
DC. Master Detail .....	48
DC. V Detail Level .....	48
Default gateway .....	110, 111
Default Gateway .....	64
Default reset .....	123
Description .....	122
Destination IP address (1) .....	109
Destination IP address (2) .....	109
Detail .....	47, 99
Detail Band .....	99
Detail Coring .....	47
Detail Frequency .....	47
Detail Gain(-) .....	47
Detail Gain(+) .....	47
DHCPv6 .....	111
Digital Extender .....	53, 89
Digital Zoom .....	89
DNR .....	50, 100
DNS .....	110
DownCon Detail .....	48
Down CONV. Mode .....	87
Download .....	124
Drop-prevention wire .....	17
DRS .....	49, 100

## E

Easy IP Setup accommodate period .....	112
Easy IP Setup Software .....	27
EEPROM .....	63
Interface .....	122
ELC Limit .....	44
End time & date .....	113
Error Status .....	62, 65
External Output .....	59
External sync signal input format .....	19

## F

Fan .....	54, 65, 85
Fan1 .....	54, 85
Fan2 .....	54, 85
Fan1 .....	65
Fan2 .....	65
firmware .....	123
Firmware file .....	122
Firmware version .....	122
Firmware Version .....	62, 63
Flesh Tone Noise SUP. .....	99
Flip Detect Angle .....	60, 88
Focus .....	34, 78, 104, 127
Focus adjust with PTZ .....	85, 88
Focus Adjust With PTZ. .....	60
Focus ADJ With PTZ. .....	106
Focus Mode .....	53, 88

## Index (continued)

Format .....	54, 55, 56, 57, 84, 87
FPGA .....	63
AVIO .....	122
Com .....	122
Lens .....	122
Frame Mix .....	44, 98
Frame rate .....	93
F-REC Black STR. Level .....	49
F-REC Dynamic Level .....	49
Freeze During Preset .....	62, 88, 106
Frequency .....	54, 55, 84, 87
Full-screen display button .....	78

## G

Gain .....	34, 44, 97
GAIN .....	79
Gamma .....	49, 100
Gamma Mode .....	49
Gamma Type .....	99
Genlock .....	40, 54, 84, 87
Horizontal Phase .....	54
Horizontal Phase Step .....	54
G/L IN connector .....	19
G Pedestal .....	46
Ground connector .....	19
Grounding .....	7

## H

H.264(1) • H.264(2) • H.264(3) • H.264(4) .....	92
H.264 transmission .....	92
HDMI .....	57, 58
HDMI connector .....	18
HDMI Out .....	89
HDR Output Select .....	56, 57
HLG Knee .....	50
HLG Knee Point .....	50
HLG Knee Slope .....	50
Hole for securing the camera pedestal .....	17
Horizontal Phase .....	87
Horizontal phase adjustment .....	40
Host auth. ....	108
Host check .....	109
Hour Meter .....	62, 65
HTTP max segment size(MSS) .....	111
HTTP port .....	111
HTTPS .....	114, 116, 119
HTTPS port .....	115

## I

Image adjust .....	96, 97
Image/Audio .....	90
Image capture size .....	92, 93
Image Capture Size .....	76
Image/Position .....	96
Image quality .....	92, 93
Image quality (JPEG) .....	92
Initial display settings for "live" page .....	90
initialization .....	64
Initialize .....	62
Input Type .....	58
Install position .....	85
Install Position .....	60, 88
Interface .....	63
Internet mode (over HTTP) .....	92
IP .....	58, 89
IP address .....	109
IP Address .....	64
IP address (IPv4) .....	110
IP address (IPv6) .....	111
IP Network .....	62, 64
IPv4 network .....	110
IPv6 network .....	111
IR ID switches .....	19, 26
Iris .....	34, 127
IRIS .....	78

Iris Mode .....	43, 97
-----------------	--------

## J

JPEG .....	92
JPEG transmission .....	92

## K

Knee Aperture Level .....	47
Knee Mode .....	50, 100
Knee Point .....	50, 100
Knee Slope .....	50, 100

## L

LAN connector for IP control .....	17
Lens .....	43, 53, 63, 65
Level Depend. ....	47
Limitation Setting .....	106
Limiters .....	131, 132
Linear Matrix .....	51, 101
Line speed .....	111
Live .....	74, 75
Live screen .....	74

## M

Main area .....	82
Main/Network .....	63
Maintenance .....	42, 62, 122
Manual .....	111
Manual shooting .....	34
Master Detail .....	47, 99
Master pedestal .....	39
Master Pedestal .....	46
Matrix .....	43, 51, 52, 53
Matrix Settings .....	100
Matrix Type .....	51, 101
Max bit rate (per client) .....	93
Max Digital Zoom .....	53, 89
Max RTP packet size .....	111
Mic input volume .....	96
Mobile terminal .....	125
Model Select .....	89
MONI .....	57, 58
MONITOR OUT connector .....	19
Mount bracket for installation surface .....	17
Multicast address .....	94
Multicast port .....	94
Multicast TTL/HOP Limit .....	94

## N

ND .....	79
ND Filter .....	45, 98
Network .....	110
Network Settings .....	110
No. ....	122
Noise Suppress .....	99
NTP .....	113
NTP port .....	113
NTP server address .....	113
NTP server address setting .....	113

## O

OIS .....	53, 89
Operation .....	65
Op.Lock .....	77
Optional accessories .....	13
OSD Menu .....	76
OSD Mix .....	58, 89
OSD Off With R-Tally .....	59
OSD Off With Tally .....	89
OSD Status .....	59, 89
Other Menu .....	76
Others .....	88
Output .....	42, 56, 57, 58, 59, 87

## Index (continued)

Output1 .....	59
Output2 .....	59
Output conditions for each video format .....	20

## P

Pan .....	125
Pan/Tilt .....	42, 60, 65
Parameter .....	92
Parameter Setting .....	92
Password .....	108
Pedestal .....	99
Pedestal Offset .....	46
Phase .....	52, 53, 101
Picture .....	43, 45, 46, 47, 48, 49, 50, 98
Picture Level .....	43, 97
Plugin Power .....	58, 96
Plug-in viewer software .....	28
Power .....	29
Power ON .....	77, 82
Preset .....	42, 61, 62, 78, 104, 126
Preset Crop .....	61
Preset D-Extender .....	88
Preset Digital Extender .....	61
Preset memory .....	35
Preset Name .....	61
Preset position .....	96, 104
Preset Scope .....	61, 88, 106
Preset Setting .....	106
Preset Speed .....	61, 88, 106
Preset Speed Table .....	61, 88
Preset Speed Unit .....	61
Preset Thumbnail Update .....	61
Preset Zoom Mode .....	62
Primary DNS server address .....	111
Primary server address .....	111
Priority stream .....	109
Product info. ....	122
P/T Speed Mode .....	60, 85

## R

Reboot .....	123
Recommended network setting for internet .....	112
Refresh interval .....	94, 109
Refresh interval (JPEG) .....	92
Remote control IDs .....	26
Reset to the default (Except thenetwork settings) .....	123
Resolution .....	126
Retype password .....	108
R Gain .....	45, 99
R Pedestal .....	46, 99
RS-422 connector .....	18
RTMP .....	79
RTSP .....	115
RTSP port .....	115
RTSP Request URL .....	115

## S

Safe mode .....	133
Saturation .....	52, 53, 101
Scene .....	43, 78, 97
Scene file .....	31
SDI Out .....	89
Secondary DNS server address .....	111
Secondary server address .....	111
Security certificate .....	120
Self-signed Certificate	
Generate .....	114, 117
Information .....	114
Service switches .....	18
Servo .....	63
Setting Status .....	83
Setup .....	41, 74
SetUp .....	81
SFP+ Fiber connector .....	19
Shooting .....	29, 32

Shooting mode .....	31
SHUTTER .....	79
Shutter Mode .....	44, 97
Shutter speed .....	34
Skin Detail .....	47
Skin Detail Effect .....	47
Smart picture flip .....	85, 88
Smart Picture Flip .....	60
Smoother live video display on the browser .....	86
Snapshot button .....	78
Speed .....	78, 104
Speed With Zoom POS. ....	106
Speed with zoom position .....	85, 88
Speed With Zoom Position .....	60
Standby .....	77, 82
Start time & date .....	113
Status .....	122
Status display lamp .....	17
Status Lamp .....	59, 89
Step/Synchro .....	44
Stream .....	76, 90
Stream Menu .....	76
Stream Type .....	109
Subnet Mask .....	64, 110
Summer time(daylight saving) .....	113
Super Gain .....	44
System .....	42, 54, 86
System log .....	122, 129
System Version .....	63

## T

Tally .....	59, 89
Tally Brightness .....	59, 89
Tally lamp .....	17, 128
Temperature .....	65
Tilt .....	125
Tilt head .....	17
Time adjustment .....	113
Time adjustment interval .....	113
Time & date .....	86, 122
Date/time .....	86
End time & date .....	86
NTP .....	86
Start time & date .....	86
Summer time (daylight saving) .....	86
Time zone .....	86
Time zone .....	113
Tone .....	58
Top Menu .....	42
Transmission priority .....	93
Transmission type .....	94
Tripod screw holes .....	19

## U

UHD Crop .....	59
Unicast port1 (Image) .....	94
Unicast port2 (Audio) .....	94
Updating .....	123
Upload .....	124
UPnP .....	113
User auth. ....	107
User check .....	108
User mng. ....	107
User name .....	107

## V

VAR .....	37
V Detail Level .....	47, 99
Ventilation holes .....	19
Video Out .....	89
Video over IP .....	90
Video Sampling .....	57
Viewer software installation counter .....	122
Volume Level .....	58
V-REC Knee Point .....	49

## Index (continued)

---

V-REC Knee Slope ..... 49

### W

---

WB ..... 79

Web screen ..... 72, 80

Web setup screen ..... 74, 81

White balance ..... 36

White Balance Mode ..... 45, 99

White Clip ..... 50, 100

White Clip Level ..... 50, 100

Wireless Control ..... 54

Wireless remote control ..... 16, 24, 26

Wireless remote control signal light-sensing area ..... 17

### Z

---

Zoom ..... 78, 104, 125

Zoom Mode ..... 53

**Panasonic Corporation**

Web Site: <http://www.panasonic.com>

© Panasonic Corporation 2018