



Product specification (design and specification subject to change without notice)

■ DISPLAY PANEL

Screen Size (Diagonal)* ¹	75-inch class (1892.7 mm / 74.6 inch)
Panel type / Backlight	ADS / Direct LED
Aspect ratio	16:9
Effective Display Area (W x H)	1649.6 mm / 927.9 mm (65.0" x 36.6")
Resolution (H x V)	3840 x 2160
Brightness (typ.)	1500 cd/m ²
Contrast Ratio (typ.)	1200:1
Dynamic Contrast Ratio	50000:1
Max. Display Colors	Approx. 1.07 Billion
Response Time (typ.)	8.0 ms (G to G)
Viewing Angle (Horizontal / Vertical)	178° / 178° (CR > 10)
Panel Life Time ¹ (typ.)	Approx. 50000 hours
Panel Surface Treatment	Anti glare type (Haze 1%)

¹ When the panel lifetime is at 50% of the brightness under the condition of 25 degrees Celsius (+/- 2 degrees Celsius).

■ CONNECTION TERMINAL

HDMI IN	HDMI Type A Connector x 2, 4K Compatible (HDCP2.2)	AUDIO: Linear PCM (Sampling frequency: 48 kHz/44.1 kHz/32 kHz)
Display Port Input	Display Port x 1 (HDCP2.2)	AUDIO: Linear PCM (Sampling frequency: 48 kHz/44.1 kHz/32 kHz)
Display Port Output	Display Port x 1 (HDCP1.4)	
DVI-D IN	DVI-D 24-pin x 1	Compliance with DVI Revision 1.0 Compatible with HDCP 1.1
SERIAL IN	D-sub 9-pin x 1, RS-232C Compatible	
IR IN / IR OUT	Stereo Mini Jack (Φ 3.5 mm) x 1 / x 1	
AUDIO IN	Stereo Mini Jack (Φ 3.5 mm) x 1 Shared video input except USB and MEMORY VIEWER	0.5 V [rms]
AUDIO OUT	Stereo Mini Jack (Φ 3.5 mm) x 1 Variable (-∞ - 0 dB) (1 kHz 0 dB Input, 10 kΩ Load)	0.5 V [rms]
LAN	RJ45 x 1 compatible with PLink™ RJ45 10BASE-T/100BASE-TX	
DIGITAL LINK / LAN	RJ45 x 1 compatible DIGITAL LINK For connection PLink™ RJ45 x 1 100BASE-TX, compatible with Long reach mode (HDCP2.2)	
USB	USB Connector (Type A) x 2 (DC 5V / MAX 2A, DC 5V / MAX 1A Compatible), (USB 3.0 is supported)	
SENSOR	4-pole sub-mini Jack (Φ 2.5 mm) x 1	
SLOT	Intel® SDM specification Corresponding size SDM-S / SDM-L, Supply power 3.3 V / MAX 1.1 A, 12 V / MAX 5.5 A	

■ AUDIO

Built in Speaker	20 W [10 W + 10 W]
External Speaker Out	30 W [15 W + 15 W] 10%THD

■ ELECTRICAL

Power Requirements	AC 110-240 V 50 Hz / 60 Hz
Power Consumption	720 W
On Mode Average Power Consumption ¹	586 W
Power Off Condition	Approx. 0.3 W
Stand-by Condition	Approx. 0.5 W
Apparent power	740 VA

¹ Based on IEC 62087 Ed.2 measurement method

■ MECHANICAL

Dimension (W x H x D) including handles	1684 x 962 x 96 mm (66.3" x 37.9" x 3.8")
	not including handles 1684 x 962 x 82 mm (66.3" x 37.9" x 3.3")
Weight	Approx. 42.2 kg (93 lbs)
Bezel Color	Black
Bezel Width	T/B/L/R 14.9 mm (0.59")
Carton Dimensions (W x H x D)	1870 x 1143 x 280 mm (73.7" x 45" x 11.1")
Gross Weight	Approx. 56 kg (123.4 lbs)
Cabinet Material	Bezel/Back: Metal
Pitch for Wall-Hanging	VESA Compliant W:600 x H:400 mm (W23.6" x H15.8") (M8 screws / Screw hole depth 13.5-38.5 mm (0.54"-1.52"))

■ INSTALLATION

Orientation ¹	Landscape / Portrait
Tilting Angle	Landscape : 0 - 20 degrees forward / backward Portrait : 0 - 20 degrees forward / backward

¹ Please contact your sales representative with regard to the tilt angle before installation.

² When installing the Display vertically, be sure that the Power Indicator comes to the lower side.

■ ENVIRONMENTAL

Operating Environment	Temperature	: 0°C to 40°C (32°F to 104°F) ¹ ; 0°C to 35°C (32°F to 95°F) ²
	Humidity	: 20% to 80% (No condensation)
	Altitude	: 0 to 2800 m (0 to 9186 ft) ²
Storage Environment	Temperature	: -20°C to 60°C (-4°F to 140°F)
	Humidity	: 20% to 80% (No condensation)

¹ : for up to 1400 m (4593 ft) altitude

² : for between 1400 m (4593 ft) and 2800 m (9186 ft) altitude

³ : Depending on the temperature or humidity conditions, uneven brightness may be observed. This is not a malfunction.

⁴ : This unevenness will disappear while applying current continuously. If not, consult the distributor.

MAIN FEATURE

USB Media Player	Yes
Failover/Failback	Yes
Data Cloning	Yes
Digital Zoom	Yes
Multi display settings	Yes
Power on Screen Delay	Yes
Automatic position correction	Yes
Screen Saver	Yes
Power Management	Yes (HDMI/DP/DVI-D/DIGITAL LINK)
Power save	Yes
Button Lock	Yes
Controller user level	Yes
Input search	Yes
6-segment color management	Yes
12-segment color management	Yes
Dynamic contrast	Yes
Color enhancement	Yes
Refine enhancer	Yes
Gradation smoother	Yes
Dynamic backlight control	Yes
Set up timer	Yes
AMX D.D.	Yes
Crestron Connected™	Yes
Extron XTP	Yes
WEB Browser control	Yes
PJLink™	Yes
Multi Monitoring & Control Software compatible	Yes
Video Wall Manager compatible	Yes
Content management Software compatible	Yes
Screen Transfer Compatible	Yes
Image settings	Yes
HDMI CEC Compatible	Yes
Blue light reduction mode	Yes
Memory Viewer	Yes
Auto vertical and horizontal determination (Accelerometer)	Yes
Portrait zoom	Yes

SNMP	Yes
Operating Time ¹	24h / day

¹ In case of running for a long time, the moving image is recommended to be displayed. If you display a still picture for an extended period, the image retention might remain on the screen. However, image retention can gradually disappear by displaying a moving images.

REMOTE CONTROL TRANSMITTER

Power Requirements	DC 3 V (2 x AAA Size batteries)
Operating distance	Approx. 7 m (23 ft)
Weight	Approx. 63 g (2.2 oz) including batteries
Dimensions (W x H x D)	48 x 134 x 20 mm (1.9" x 5.3" x 0.8")

STANDARD (CERTIFICATIONS)

SAFETY REGULATIONS	CAN/CSA-C22.2 No. 62368-1-14 EN62368-1:2014 + A11:2017
RADIATION REGULATIONS	FCC CFR 47, Part 15, Subpart B Class A ANSI C63.4-2014 ICES-003 Issue6:2016 EN55032:2015 EN55035:2017 EN61000-3-2:2014 EN61000-3-3:2013

INCLUDED ACCESSORIES

- Remote Control - Batteries (AAA size) x 2
- AC cord (approx. 2.0 m (79")) - Clamper x 3
- USB memory cover x 1 - SLOT adapter x 1
- Operating Instruction Book - Sensor Module x 1
- 4-pole micro plug cable (Approx. 3 m) x 1
- Double-sided tape x 2

OPTIONAL ACCESSORIES

Early Warning Software	ET-SWA100/105 series
Wall - hanging Bracket	TY-WK98PV1
3G-SDI Terminal board	TY-SB01SS
Wireless Presentation System Receiver Board	TY-SB01WP

DIMENSIONS

Cautions: This drawing is not a scale
Units : mm (inches)

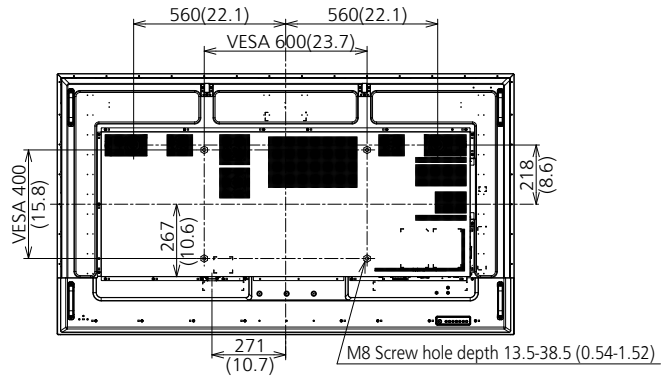
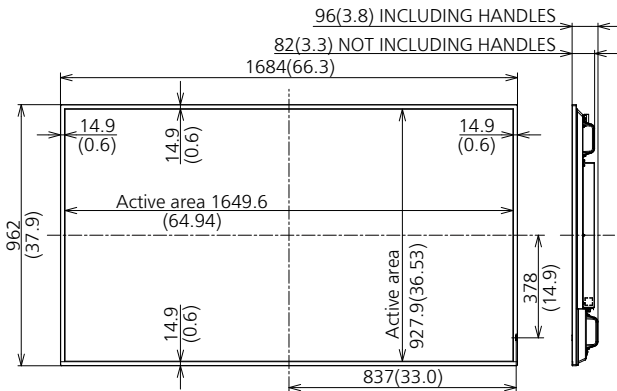

CONNECTION TERMINAL

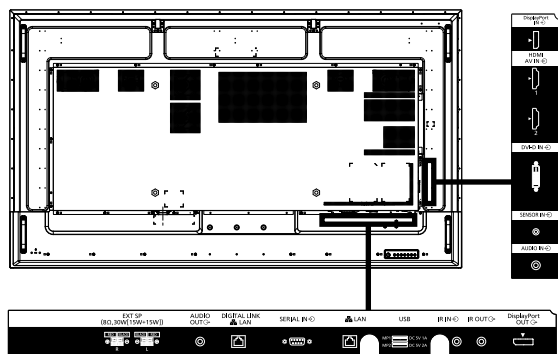

1 Specifications and appearance are subject to change without notice.

List of correspondence signals

The picture signal which can indicate this machine is as it is the following table.

- Specific HDMI signals inside the plug and play compatible signal table are as it follows.
1 : 4K/60p (HDR), 2 : 4K/60p (SDR), 3 : 4K/30p, 4 : 2K

Correspondence signal	Resolution (dot)	Scan rate		Dot clock rate (MHz)	Format ²	Plug and play compatible signal ³						
		Horizontal (kHz)	Vertical (Hz)			HDMI				DL	DP	DVI-D
						1	2	3	4			
480/60i	720 (1440) x 480i ¹	15.73	59.94	27.00	D/H/DL/DP	○	○	○	○	○	-	-
576/50i	720 (1440) x 576i ¹	15.63	50.00	27.00	D/H/DL/DP	○	○	○	○	○	-	-
480/60p	720 x 483	31.47	59.94	27.00	D/H/DL/DP	○	○	○	○	○	○	-
576/50p	720 x 576	31.25	50.00	27.00	D/H/DL/DP	○	○	○	○	○	○	-
720/60p	1280 x 720	45.00	60.00	74.25	D/H/DL/DP	○	○	○	○	○	○	-
720/50p	1280 x 720	37.50	50.00	74.25	D/H/DL/DP	○	○	○	○	○	○	-
1080/60i	1920 x 1080i	33.75	60.00	74.25	D/H/DL/DP	○	○	○	○	○	○	-
1080/50i	1920 x 1080i	28.13	50.00	74.25	D/H/DL/DP	○	○	○	○	○	○	-
1080/24p	1920 x 1080	27.00	24.00	74.25	D/H/DL/DP	○	○	○	○	○	○	-
1080/24PsF	1920 x 1080i	27.00	48.00	74.25	D/H/DL/DP	-	-	-	-	-	-	-
1080/25p	1920 x 1080	28.13	25.00	74.25	D/H/DL/DP	○	○	○	○	○	○	-
1080/30p	1920 x 1080	33.75	30.00	74.25	D/H/DL/DP	○	○	○	○	○	○	-
1080/60p	1920 x 1080	67.50	60.00	148.50	D/H/DL/DP	○	○	○	○	○	○	-
1080/50p	1920 x 1080	56.25	50.00	148.50	D/H/DL/DP	○	○	○	○	○	○	-
2K/24p	2048 x 1080	27.00	24.00	74.25	D/H/DL/DP	-	-	-	-	-	-	-
2K/25p	2048 x 1080	28.13	25.00	74.25	D/H/DL/DP	-	-	-	-	-	-	-
2K/30p	2048 x 1080	33.75	30.00	74.25	D/H/DL/DP	-	-	-	-	-	-	-
2K/48p	2048 x 1080	54.00	48.00	148.50	D/H/DL/DP	-	-	-	-	-	-	-
2K/60p	2048 x 1080	67.50	60.00	148.50	D/H/DL/DP	-	-	-	-	-	-	-
2K/50p	2048 x 1080	56.25	50.00	148.50	D/H/DL/DP	-	-	-	-	-	-	-
3840 x 2160/24p	3840 x 2160	54.00	24.00	297.00	H/DL/DP	○	○	○	-	○	○	-
3840 x 2160/25p	3840 x 2160	56.25	25.00	297.00	H/DL/DP	○	○	○	-	○	○	-
3840 x 2160/30p	3840 x 2160	67.50	30.00	297.00	H/DL/DP	○	○	○	-	○	○	-
3840 x 2160/60p	3840 x 2160	135.00	60.00	594.00	H/DL ⁴ /DP	○	○	-	-	-	○	-
3840 x 2160/50p	3840 x 2160	112.50	50.00	594.00	H/DL ⁴ /DP	○	○	-	-	-	○	-
4096 x 2160/24p	4096 x 2160	54.00	24.00	297.00	H/DL/DP	○	○	○	-	○	○	-
4096 x 2160/25p	4096 x 2160	56.25	25.00	297.00	H/DL/DP	○	○	○	-	○	○	-
4096 x 2160/30p	4096 x 2160	67.50	30.00	297.00	H/DL/DP	○	○	○	-	○	○	-
4096 x 2160/60p	4096 x 2160	135.00	60.00	594.00	H/DL ⁴ /DP	○	○	-	-	-	○	-
4096 x 2160/50p	4096 x 2160	112.50	50.00	594.00	H/DL ⁴ /DP	○	○	-	-	-	○	-
640 x 400/70	640 x 400	31.47	70.09	25.18	D/H/DL/DP	-	-	-	-	-	-	-
640 x 400/85	640 x 400	37.86	85.08	31.50	D/H/DL/DP	-	-	-	-	-	-	-
640 x 480/60	640 x 480	31.47	59.94	25.18	D/H/DL/DP	○	○	○	○	○	○	○
640 x 480/67	640 x 480	35.00	66.67	30.24	D/H/DL/DP	-	-	-	-	-	-	-
640 x 480/73	640 x 480	37.86	72.81	31.50	D/H/DL/DP	-	-	-	-	-	-	-
640 x 480/75	640 x 480	37.50	75.00	31.50	D/H/DL/DP	-	-	-	-	-	-	-
640 x 480/85	640 x 480	43.27	85.01	36.00	D/H/DL/DP	-	-	-	-	-	-	-
800 x 600/56	800 x 600	35.16	56.25	36.00	D/H/DL/DP	-	-	-	-	-	-	-
800 x 600/60	800 x 600	37.88	60.32	40.00	D/H/DL/DP	○	○	○	○	○	○	○
800 x 600/72	800 x 600	48.08	72.19	50.00	D/H/DL/DP	-	-	-	-	-	-	-
800 x 600/75	800 x 600	46.88	75.00	49.50	D/H/DL/DP	-	-	-	-	-	-	-
800 x 600/85	800 x 600	53.67	85.06	56.25	D/H/DL/DP	-	-	-	-	-	-	-
832 x 624/75	832 x 624	49.72	74.55	57.28	D/H/DL/DP	-	-	-	-	-	-	-
852 x 480/60	852 x 480	31.47	59.94	34.24	D/H/DL/DP	-	-	-	-	-	-	-
1024 x 768/50	1024 x 768	39.55	50.00	51.89	D/H/DL/DP	-	-	-	-	-	-	-
1024 x 768/60	1024 x 768	48.36	60.00	65.00	D/H/DL/DP	○	○	○	○	○	○	○
1024 x 768/70	1024 x 768	56.48	70.07	75.00	D/H/DL/DP	-	-	-	-	-	-	-
1024 x 768/75	1024 x 768	60.02	75.03	78.75	D/H/DL/DP	-	-	-	-	-	-	-
1024 x 768/82	1024 x 768	65.55	81.63	86.00	D/H/DL/DP	-	-	-	-	-	-	-
1024 x 768/85	1024 x 768	68.68	85.00	94.50	D/H/DL/DP	-	-	-	-	-	-	-
1066 x 600/60	1066 x 600	37.64	59.94	53.00	D/H/DL/DP	-	-	-	-	-	-	-
1152 x 864/60	1152 x 864	53.70	60.00	81.62	D/H/DL/DP	-	-	-	-	-	○	○
1152 x 864/70	1152 x 864	63.99	70.02	94.20	D/H/DL/DP	-	-	-	-	-	-	-
1152 x 864/75	1152 x 864	67.50	75.00	108.00	D/H/DL/DP	-	-	-	-	-	-	-
1152 x 864/85	1152 x 864	77.09	85.00	119.65	D/H/DL/DP	-	-	-	-	-	-	-
1152 x 870/75	1152 x 870	68.68	75.06	100.00	D/H/DL/DP	-	-	-	-	-	-	-
1280 x 720/60	1280 x 720	44.76	60.00	74.48	D/H/DL/DP	-	-	-	-	-	○	○
1280 x 768/50	1280 x 768	39.55	49.94	65.18	D/H/DL/DP	-	-	-	-	-	-	-
1280 x 768/60	1280 x 768	47.70	60.00	80.14	D/H/DL/DP	-	-	-	-	-	-	-
1280 x 768/60	1280 x 768	47.78	59.87	79.50	D/H/DL/DP	-	-	-	-	-	-	-
1280 x 800/50	1280 x 800	41.20	50.00	68.56	D/H/DL/DP	-	-	-	-	-	-	-
1280 x 800/60	1280 x 800	49.31	59.91	71.00	D/H/DL/DP	-	-	-	-	-	-	-
1280 x 800/60	1280 x 800	49.70	59.81	83.50	D/H/DL/DP	-	-	-	-	-	○	○
1280 x 960/60	1280 x 960	60.00	60.00	108.00	D/H/DL/DP	-	-	-	-	-	-	-
1280 x 1024/60	1280 x 1024	63.98	60.02	108.00	D/H/DL/DP	○	○	○	○	○	○	○
1280 x 1024/75	1280 x 1024	79.98	75.02	135.00	D/H/DL/DP	-	-	-	-	-	-	-
1280 x 1024/85	1280 x 1024	91.15	85.02	157.50	D/H/DL/DP	-	-	-	-	-	-	-
1360 x 768/60	1360 x 768	47.71	60.02	85.50	D/H/DL/DP	-	-	-	-	-	-	-
1360 x 768/60	1360 x 768	47.70	60.00	84.72	D/H/DL/DP	-	-	-	-	-	-	-
1360 x 768/60	1360 x 768	47.72	59.80	84.75	D/H/DL/DP	-	-	-	-	-	-	-
1366 x 768/50	1366 x 768	39.55	50.00	69.92	D/H/DL/DP	-	-	-	-	-	-	-
1366 x 768/60	1366 x 768	48.39	60.03	86.71	D/H/DL/DP	-	-	-	-	-	-	-
1366 x 768/60	1366 x 768	48.00	60.00	72.00	D/H/DL/DP	-	-	-	-	-	-	-
1366 x 768/50	1366 x 768	39.56	49.89	69.00	D/H/DL/DP	-	-	-	-	-	-	-
1366 x 768/60	1366 x 768	47.71	59.79	85.50	D/H/DL/DP	-	-	-	-	-	-	-
1400 x 1050/60	1400 x 1050	65.22	60.00	122.61	D/H/DL/DP	-	-	-	-	-	-	-
1400 x 1050/75	1400 x 1050	82.20	75.00	155.85	D/H/DL/DP	-	-	-	-	-	-	-
1440 x 900/60	1440 x 900	55.47	59.90	88.75	D/H/DL/DP	-	-	-	-	-	-	-

Correspondence signal	Resolution (dot)	Scan rate		Dot clock rate (MHz)	Format ²	Plug and play compatible signal ⁵						
		Horizontal (kHz)	Vertical (Hz)			HDMI				DL	DP	DVI-D
						1	2	3	4			
1440 x 900/60	1440 x 900	55.92	60.00	106.47	D/H/DL/DP	-	-	-	-	-	-	-
1600 x 900/50	1600 x 900	46.30	50.00	97.05	D/H/DL/DP	-	-	-	-	-	-	-
1600 x 900/60	1600 x 900	60.00	60.00	108.00	D/H/DL/DP	-	-	-	-	-	-	-
1600 x 900/60	1600 x 900	55.99	59.95	118.25	D/H/DL/DP	-	-	-	-	-	-	-
1600 x 900/60	1600 x 900	55.92	60.00	119.00	D/H/DL/DP	-	-	-	-	-	○	○
1600 x 1200/60	1600 x 1 200	75.00	60.00	162.00	D/H/DL/DP	-	-	-	-	-	-	-
1680 x 1050/60	1680 x 1 050	65.29	59.95	146.25	D/H/DL/DP	-	-	-	-	-	-	-
1920 x 1080/60	1920 x 1 080 ³	66.59	59.93	138.50	D/H/DL/DP	-	-	-	-	-	-	-
1920 x 1080/60	1920 x 1 080	67.50	60.00	148.50	D/H/DL/DP	○	○	○	○	○	○	○
1920 x 1200/60	1920 x 1 200	74.04	59.95	154.00	D/H/DL/DP	○	○	○	○	○	○	○
1920 x 2160/60	1920 x 2160	133.29	59.99	277.25	H/DL/DP	-	-	-	-	-	-	-
1920 x 2160/60	1920 x 2160	135.00	60.00	297.00	H/DL/DP	-	-	-	-	-	-	-
2560 x 1440/60	2560 x 1440	88.79	59.95	241.50	H/DL/DP	-	-	○	-	○	○	-
2560 x 1600/50	2560 x 1600	82.37	49.95	286.00	H/DL/DP	-	-	-	-	-	-	-
2560 x 1600/60	2560 x 1600	98.71	59.97	268.50	H/DL/DP	-	-	-	-	-	-	-
3840 x 1080/60	3840 x 1080	66.63	59.97	266.50	H/DL/DP	-	-	-	-	-	-	-
3840 x 2160/30	3840 x 2160	65.69	29.98	262.75	H/DL/DP	-	-	-	-	-	○	-
3840 x 2160/60	3840 x 2160	133.31	60.00	533.25	H/DL/DP	-	-	-	-	-	○	-

1: Pixel-Repetition signal (dot clock frequency 27.0 MHz) only

2: Signals to represent formats are as follows.

- D : DVI-D (DVI-D IN)
- H : HDMI (HDMI 1, HDMI 2)
- DL: DIGITAL LINK (DIGITAL LINK)
- DP: Display Port (Display Port)

3: Based on VESA CVT-RB (Reduced Blanking) standard

4: YCbCr 4:2:0 format only supported

5: Signals with ○ in the Plug and Play-supported signal column are the ones written in EDID (Extended Display Identification Data) of this unit.

For signals without ○ in the Plug and Play-supported signal column, resolutions may not be selected on the PC side even if this unit supports those signals.

Note

- An auto detected signal format may be differently displayed from the actual input signal.
- [i] shown after the number of dots of resolution means the interlace signal.
- When 1080/30PsF signal and 1080/25PsF signal are input, they are processed as 1080/60i signal and 1080/50i signal, and then displayed.
- When a 1920 x 2160/60 signal (dot clock frequency 297.00 MHz, DIGITAL LINK format) is input Display as 3840 x 2160 / 60p.

● Drawing of terminals

View from back

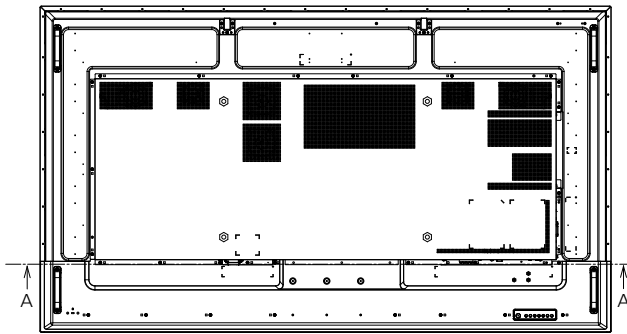

Magnified figure of terminal b

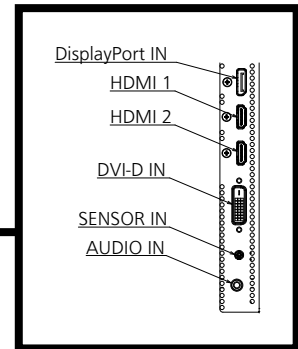

Magnified figure of terminal a

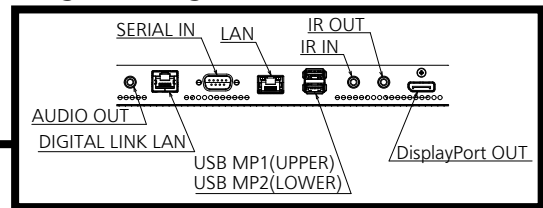

SECTION A-A

Sectional view of terminal a

(AUDIO OUT / DIGITAL LINK LAN / SERIAL IN / LAN / USB MP1 / USB MP2 / IR IN/OUT / DisplayPort OUT)

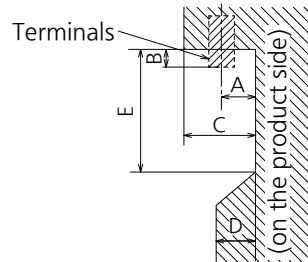

**Terminal a
75SQ1HW Terminal (Bottom)**

Units : mm (inch)

	AUDIO OUT	DIGITAL LINK LAN	SERIAL IN	LAN	USB MP1	USB MP2	IR IN/OUT	DisplayPort OUT
A	14.8 (0.58)	15.0 (0.59)	14.6 (0.57)	12.6 (0.49)	19.7 (0.77)	11.2 (0.44)	14.8 (0.58)	11.7 (0.46)
B	2.7 (0.11)	-	5.2 (0.20)	-	-	-	2.7 (0.11)	-
C					41.2 (1.62)			
D					11.6 (0.46)			
E					95.5 (3.76)			

Sectional view of terminal b

(DisplayPort IN / HDMI 1/2 / DVI-D IN / SENSOR IN / AUDIO IN)

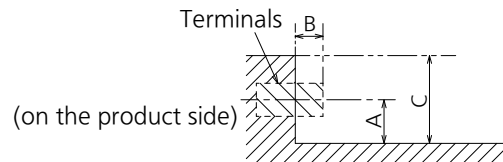

**Terminal b
75SQ1HW Terminal (Side)**

Units : mm (inch)

	DisplayPort IN	HDMI 1/2	DVI-D IN	SENSOR IN	AUDIO IN
A	11.7 (0.46)	11.6 (0.46)	13.2 (0.52)	13.3 (0.52)	14.8 (0.58)
B	-	-	5.6 (0.22)	1.7 (0.07)	2.7 (0.11)
C	41.2 (1.62)				

1 Due to the construction of terminal, some types of connecting cable or USB memory device cannot be used. Be sure to use connecting cable or USB memory device after confirmation in this drawing.