

Panasonic[®]

Operating Instructions

Live Switcher

Model No. **AV-UHS500P**

Model No. **AV-UHS500E**

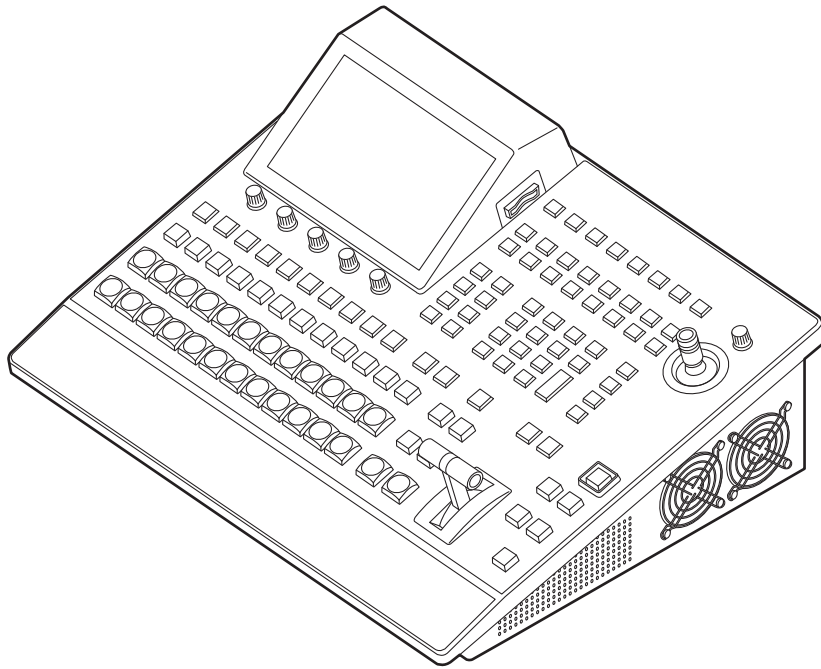

HDMI[™]



Before operating this product, please read the instructions carefully and save this manual for future use. Please carefully read the "Read this first!" (pages 3 to 7) of this Manual before use.

● **Information on software for this product**

1. Included with this product is software licensed under the GNU General Public License (GPL) and GNU Lesser General Public License (LGPL), and users are hereby informed that they have the right to obtain, change and redistribute the source codes of this software.

To obtain the source codes, go to the following website:

<https://pro-av.panasonic.net/>

The manufacturer asks users to refrain from directing inquiries concerning the source codes they have obtained and other details to its representatives.

2. Included with this product is software which is licensed under MIT-License.
3. This product includes software which is licensed under FreeType Project (www.freetype.org).

For more information about these, refer to the website below.

<https://pro-av.panasonic.net/manual/en/index.html>

Details are given in the original (English language) text.

Trademarks and registered trademarks

- The terms HDMI and HDMI High-Definition Multimedia Interface, and the HDMI Logo are trademarks or registered trademarks of HDMI Licensing Administrator, Inc. in the United States and other countries.
- SDXC Logo is a trademark of SD-3C, LLC.
- Primatte® is the registered trademark of Photron Limited.
- Photron Limited is the holder of the intellectual rights to Primatte®.
- Photron Limited is the holder of the patent for Primatte®.
- Other names of companies and products contained in these Operating Instructions may be trademarks or registered trademarks of their respective owners.

About copyright and licence

Distributing, copying, disassembling, reverse compiling, reverse engineering, and also exporting in violation of export laws of the software provided with this unit are expressly prohibited.

Abbreviations

The following abbreviations are used in this manual.

- Both SDHC memory cards and SDXC memory cards are described as “memory cards” in this manual. When individual descriptions are provided, they are featured individually.
- Personal computers are referred to as “computers”.

Furthermore, the product numbers of equipment are referred to as follows.

Model number of unit	Model number given in manual
AV-UHS500P	AV-UHS500
AV-UHS500E	AV-UHS500
AV-UHS5M1G	AV-UHS5M1
AV-UHS5M2G	AV-UHS5M2
AV-UHS5M3G	AV-UHS5M3
AV-UHS5M4G	AV-UHS5M4
AV-UHS5M5G	AV-UHS5M5

Illustrations and screen displays featured in the manual

- What is shown in the manual's illustrations and screen displays may differ from how it is actually appears.

Read this first!

WARNING:

This equipment must be grounded. To ensure safe operation, the three-pin plug must be inserted only into a standard three-pin power outlet which is effectively grounded through normal household wiring. Extension cords used with the equipment must have three cores and be correctly wired to provide connection to the ground. Wrongly wired extension cords are a major cause of fatalities. The fact that the equipment operates satisfactorily does not imply that the power outlet is grounded or that the installation is completely safe. For your safety, if you are in any doubt about the effective grounding of the power outlet, please consult a qualified electrician.

WARNING:

- To reduce the risk of fire or electric shock, do not expose this equipment to rain or moisture.
- To reduce the risk of fire or electric shock, keep this equipment away from all liquids. Use and store only in locations which are not exposed to the risk of dripping or splashing liquids, and do not place any liquid containers on top of the equipment.

WARNING:

Always keep memory cards (optional accessory) or accessory (mounting screws) out of the reach of babies and small children.

WARNING:

This equipment is compliant with Class A of CISPR 32. In a residential environment this equipment may cause radio interference.

CAUTION:

Do not remove panel covers by unscrewing. To reduce the risk of electric shock, do not remove the covers. No user serviceable parts inside. Refer servicing to qualified service personnel.

CAUTION:

To reduce the risk of fire or electric shock, refer mounting of the optional interface boards to qualified service personnel.

CAUTION:

To reduce the risk of fire or electric shock and annoying interference, use the recommended accessories only.

CAUTION:

In order to maintain adequate ventilation, do not install or place this unit in a bookcase, built-in cabinet or any other confined space. To prevent risk of electric shock or fire hazard due to overheating, ensure that curtains and any other materials do not obstruct the ventilation.

CAUTION:

The mains plug of the power supply cord shall remain readily operable. The AC receptacle (mains socket outlet) shall be installed near the equipment and shall be easily accessible. To completely disconnect this equipment from the AC mains, disconnect the power cord plug from the AC receptacle.

CAUTION:

A coin type battery is installed inside of the unit. Do not expose the unit to excessive heat such as sunshine, fire or the like.

CAUTION:

Naked flame sources, such as lighted candles, should not be placed on the apparatus.

For U.S.A. and Canada

CAUTION:

This apparatus can be operated at a voltage in the range of 100 – 240 V AC. Voltages other than 120 V are not intended for U.S.A. and Canada. Operation at a voltage other than 120 V AC may require the use of a different AC plug. Please contact either a local or foreign Panasonic authorized service center for assistance in selecting an alternate AC plug.

 indicates safety information.

Read this first!

The symbols on this product (including the accessories) represent the following:

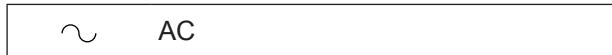

廢電池請回收

For AV-UHS500P

FCC NOTICE (USA)

Supplier's Declaration of Conformity

Model Number: AV-UHS500P

Trade Name: Panasonic

Responsible Party: Panasonic Corporation of North America

Two Riverfront Plaza, Newark, NJ 07102

Support contact: 1-800-524-1448

This device complies with part 15 of the FCC Rules.

Operation is subject to the following two conditions:

(1) This device may not cause harmful interference, and (2) this device must accept any interference received, including interference that may cause undesired operation.

FCC Note:

This equipment has been tested and found to comply with the limits for a class A digital device, pursuant to Part 15 of the FCC Rules. These limits are designed to provide reasonable protection against harmful interference when the equipment is operated in a commercial environment. This equipment generates, uses, and can radiate radio frequency energy, and if not installed and used in accordance with the instruction manual, may cause harmful interference to radio communications. Operation of this equipment in a residential area is likely to cause harmful interference in which case the user will be required to correct the interference at his own expense.

Warning:

To assure continued FCC emission limit compliance, the user must use only shielded interface cables when connecting to external units. Also, any unauthorized changes or modifications to this equipment could void the user's authority to operate it.

NOTIFICATION (Canada)

CAN ICES-3 (A)/NMB-3(A)

 indicates safety information.

Read this first!

For AV-UHS500E

Caution for AC Mains Lead

FOR YOUR SAFETY PLEASE READ THE FOLLOWING TEXT CAREFULLY.

This product is equipped with 3 types of AC mains cable.

Appropriate mains cable must be used in each local area, since the other type of mains cable is not suitable.

FOR CONTINENTAL EUROPE, ETC.
Not to be used in the U.K.

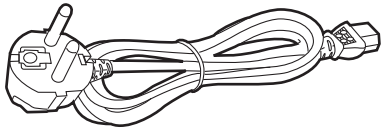

FOR U.K. ONLY

If the plug supplied is not suitable for your socket outlet, it should be cut off and appropriate one fitted.

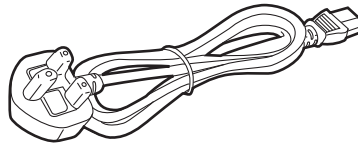

FOR INDIA ONLY

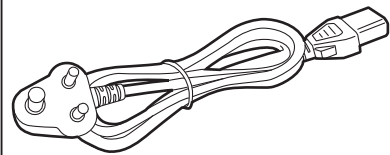

FOR U.K. ONLY

This appliance is supplied with a moulded three pin mains plug for your safety and convenience.

A 13 amp fuse is fitted in this plug.

Should the fuse need to be replaced please ensure that the replacement fuse has a rating of 13 amps and that it is approved by ASTA or BSI to BS1362.

Check for the ASTA mark  or the BSI mark  on the body of the fuse.

If the plug contains a removable fuse cover you must ensure that it is refitted when the fuse is replaced.

If you lose the fuse cover the plug must not be used until a replacement cover is obtained.

A replacement fuse cover can be purchased from your local Panasonic Dealer.

How to replace the fuse

1. Open the fuse compartment with a screwdriver.

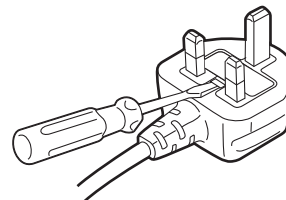

2. Replace the fuse.

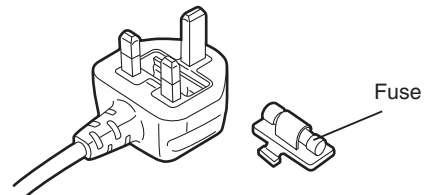

 indicates safety information.

Manufactured by: Panasonic Corporation, Osaka, Japan
Importer's name and address of pursuant to EU rules:
Panasonic Marketing Europe GmbH
Panasonic Testing Centre
Winsbergring 15, 22525 Hamburg, Germany

Read this first!

EMC NOTICE FOR THE PURCHASER/USER OF THE APPARATUS

1. Pre-requisite conditions to achieving compliance with the above standards

<1> Peripheral equipment to be connected to the apparatus and special connecting cables

- The purchaser/user is urged to use only equipment which has been recommended by us as peripheral equipment to be connected to the apparatus.
- The purchaser/user is urged to use only the connecting cables described below.

<2> For the connecting cables, use shielded cables which suit the intended purpose of the apparatus.

- Video signal connecting cables
Use double shielded coaxial cables, which are designed for 75-ohm type high-frequency applications, for SDI (Serial Digital Interface).
Coaxial cables, which are designed for 75-ohm type high-frequency applications, are recommended for analog video signals.
- Audio signal connecting cables
If your apparatus supports AES/EBU serial digital audio signals, use cables designed for AES/EBU.
Use shielded cables, which provide quality performance for high-frequency transmission applications, for analog audio signals.
- Other connecting cables (LAN, RS-422)
Use shielded cables, which provide quality performance for high-frequency applications, as connecting cables.
- When connecting to the DVI signal terminal, use a cable with a ferrite core.
- If your apparatus is supplied with ferrite core(s), they must be attached on cable(s) following instructions in this manual.

2. Performance level

The performance level of the apparatus is equivalent to or better than the performance level required by these standards. However, the apparatus may be adversely affected by interference if it is being used in an EMC environment, such as an area where strong electromagnetic fields are generated (by the presence of signal transmission towers, cellular phones, etc.). In order to minimize the adverse effects of the interference on the apparatus in cases like this, it is recommended that the following steps be taken with the apparatus being affected and with its operating environment:

1. Place the apparatus at a distance from the source of the interference.
2. Change the direction of the apparatus.
3. Change the connection method used for the apparatus.
4. Connect the apparatus to another power outlet where the power is not shared by any other appliances.

Turkey Only

AEEE Yönetmeliğine Uygundur.

AEEE Complies with Directive of Turkey.

Disposal of Old Equipment and Batteries

Only for European Union and countries with recycling systems

These symbols on the products, packaging, and/or accompanying documents mean that used electrical and electronic products and batteries must not be mixed with general household waste.

For proper treatment, recovery and recycling of old products and used batteries, please take them to applicable collection points in accordance with your national legislation.

By disposing of them correctly, you will help to save valuable resources and prevent any potential negative effects on human health and the environment.

For more information about collection and recycling, please contact your local authority, dealer or supplier.

Penalties may be applicable for incorrect disposal of this waste, in accordance with national legislation



Note for the battery symbol (bottom symbol):

This symbol might be used in combination with a chemical symbol. In this case it complies with the requirement set by the Directive for the chemical involved.

TO REMOVE BATTERY

Back-up Battery (Lithium Battery)

- For the removal of the battery for disposal at the end of its service life, please consult your dealer.

Read this first!

ІНФОРМАЦІЯ ПРО ПІДТВЕРДЖЕННЯ ВІДПОВІДНОСТІ ПРОДУКТУ

Виробник:	Panasonic Corporation	Панасонік Корпорейшн
Адреса виробника:	Kadoma, Osaka, Japan	Кадома, Осака, Японія
Країна походження:	Japan	Японія

Імпортёр:	ТОВ "ПАНАСОНІК УКРАЇНА ЛТД"
Адреса Імпортёра:	провулок Охтирський, будинок 7, місто Київ, 03066, Україна

Примітки:

Термін служби виробу	7 років
----------------------	---------

Дату виготовлення можна визначити за комбінацією букв і цифр серійного номера, що розташований на маркувальній табличці виробу.

Приклад:

X X XXXXXXX

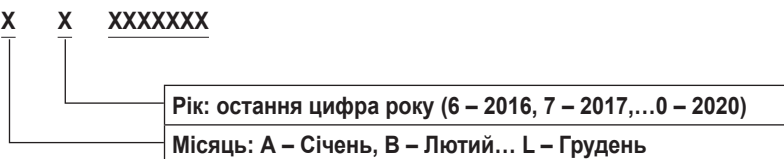

Contents

Read this first!	3	Setting the wipe start position	37
Before use	11	Modifying wipe.....	37
Overview	11	Setting the latency.....	38
Concerning the ratings display	11	Creating an animated wipe.....	39
Disclaimer of warranty	11	Key	39
Network security	11	Selecting the key type	40
Precautions for use	12	Selecting the key material	41
Installation precautions	13	Key transitions.....	42
Features	14	Key preview	44
Accessories	15	Adjusting the luminance key and linear key	45
Installation and connections	15	Adjusting the chroma key	45
How to install the optional units.....	15	Key decorations.....	51
Parts and their functions	17	Masking the key signals	52
Control panel	17	Flying key	52
Crosspoint area.....	18	Setting the priority	53
Memory/wipe pattern/number key area.....	19	PinP (picture in picture)	54
User button area.....	20	Selecting the PinP channel and material	54
Transition area.....	20	Selecting Shape	54
Display area	22	PinP adjustments	55
Positioner area	24	Linking Key PinP and DSK PinP	55
Memory card area	25	PinP decorations	56
Rear panel area	26	Trimming settings	57
Preparations	27	DSK (downstream key)	58
Turning the unit's power on and off	27	Selecting the DSK type	58
Basic menu operations	28	Selecting the DSK material	59
Menu configuration and operations	28	DSK transitions.....	60
Keyboard screen operations.....	30	DSK preview.....	61
Menu delegation function	30	DSK adjustments.....	61
Setting the system format.....	31	Masking the DSK signals	62
Setting the date and time	31	Key Link	63
Basic operations	32	FTB (Fade to Black)	63
Background transition	32	Internal color signals	64
Selecting the bus.....	32	Setting the color background.....	64
Selecting the bus using the SHIFT function	32	Setting the Wash effect.....	65
Selecting the bus mode.....	33	Internal color bar signal	65
Selecting the transition mode	33	Test tone settings	65
Manual transition	34	Switching the AUX output	66
Auto transition	34	Selecting the AUX output materials.....	66
Cut transition	34	AUX1/2 transitions.....	66
Wipe	35	Setting enable/disable for the AUX1/2 transition	67
Selecting the wipe pattern	35	Memory	68
Selecting the wipe direction.....	36	Memory registration	69
Wipe decorations (border, soft effect)	36	Memory recall items	69
		Storing the settings in the memory (Store).....	70
		Recalling the operations stored in the memory (Recall)	71
		Deleting the operations stored in the memory (Delete)	72
		Selecting the buses whose settings are to be registered and or played back.....	73

Contents

Setting effect dissolve (shot memory)	74	Setting the tally displays	126
Editing event memory timelines	75	Changing the material names	127
Macro memory settings	80	Setting the level meters	127
Registering memories (Register)	83	Setting the input signal marks	128
Video memories	84	Setting the markers	128
Recording still images (Still)	85	Ancillary settings for the AUX bus, PGM, and PVW... 129	
Recording moving images (Clip)	86	Audio settings for the AUX bus, PGM, and PVW	130
Saving to the internal storage.....	87	System settings	131
Playing back moving images (Clip)	88	Setting the system format	131
Internal storage management	91	Switcher mode settings	131
Still playlists.....	93	Dynamic range and color range settings.....	131
Memory card.....	96	Setting the crosspoints	132
Formatting memory cards	98	Assigning signals to the crosspoints	132
Saving data on memory cards	98	Setting the crosspoint switching	133
Loading data from memory cards	99	Button assignments.....	134
Deleting files on memory cards.....	100	Setting the user buttons	134
Displaying the memory card information.....	101	Setting the date and time	135
Internal storage	102	Network settings	135
Project file management screen.....	102	Setting the built-in display backlight and button	
Saving project files to the internal storage	102	illumination	136
Loading project files from the internal storage	103	Status displays.....	137
Deleting project files from the internal storage.....	103	Alarm status displays	137
Changing the filenames of project files saved in the		Alarm message	137
internal storage	104	Displaying information about the version and optional	
Waveform monitor settings.....	105	units	138
Input/output signal settings	106	Initialization	139
Input signal settings	106	Initializing setting data.....	139
Settings for the exclusionary input connectors.....	108	Initializing fader	139
Settings for the color range for input signals	108	Remote camera link functions	140
Checking the input signal status.....	109	Settings for connections to remote cameras	141
Setting the frame synchronizer.....	109	Selecting the terminals for remote camera	
Setting the delay amount.....	110	connection	141
Freezing the input signals	110	IP address settings.....	141
Setting the material names	111	Remote camera port settings.....	142
Setting the up-converter.....	111	Remote camera authentication settings.....	142
Color Corrector.....	112	Checking the remote camera connection status	142
Setting the HDMI input signals.....	115	Remote camera operation direction settings.....	143
Displaying the HDMI input signal information.....	116	Remote camera tally control settings	143
Output signal settings	117	Selecting the cameras to be operated.....	144
Assigning the output signals.....	118	Controlling in the camera control screen.....	145
Setting the SDI output color range	118	Remote camera settings	146
Setting the HDMI output signals.....	119	Selecting the remote camera, checking information, and	
Setting the down-converter (optional)	120	controlling power.....	146
Setting the sync signals	121	Remote camera control speed settings.....	147
Adjusting the output signal phase	121	Remote camera on-screen menu and color bar	
Setting the multi view display	125	settings	147
Setting the screen layout.....	125	Remote camera lens control settings.....	148
Setting the split frame and characters.....	126	Remote camera image adjustment settings.....	148

Contents

Remote camera preset memory playback settings	149
Disabling remote camera control.....	149
Controlling in the camera preset memory screen	150
Storing preset memories	152
Recalling preset memories.....	152
Deleting preset memories	152
Selecting a page of preset memories.....	153
ROI function	154
ROI mode settings.....	156
Adjusting the position and range for ROI extraction	157
ROI adjustments from the CAM CONT screen	158
ROI preset memory	159
External interfaces	161
Setting the GPI I/O.....	161
LAN.....	164
Controlling with external panels.....	165
Preparations	165
External panel settings.....	165
Settings on this unit when external panels are connected	165
List of bus IDs and source IDs	166
External Control	171
Macro Trigger	172
Appearance	173
Specifications	174
Setting menu table	176
Appendix (glossary).....	210
Index	213

Before use

■ Overview

This unit is a 1 ME digital video switcher which supports a multiple number of 4K, 3G and HD formats.

The 12G-SDI-compatible AV-UHS500 4K live switcher has basic functions that rival those in larger high-end switchers, making available to you the same operability you would use for producing HD video when you produce 4K video. With its excellent portability, the all-in-one main unit can easily be transported for use at a variety of live music, sport, and entertainment events.

Furthermore, along with compatibility with multiple formats (4K, 3G, and HD), the addition of optional units makes it possible to expand to a maximum of 16 SDI inputs, enabling smooth operation even at events with a large number of cameras.

The keyers, which enable a variety of program production techniques, are equipped with a total of five keyers including two channels for chroma keys and two channels of PinP.

Furthermore, you are able to flexibly select video output to match your purposes, even when you have scenes using different formats, using features such as the up/down converters, HDR/SDR converters, and the ITU-R BT.2020/ BT.709 converters.

We have endeavored to make the product useful in a variety of portable applications, such as special event venues, broadcast vehicles, at university or company presentations, etc., and of course inside broadcasters themselves. This 4K live switcher really exhibits its high performance capabilities when it produces living images on location.

■ Concerning the ratings display

The name, model number, and power rating for the unit are displayed on the rear panel.

■ Disclaimer of warranty

IN NO EVENT SHALL Panasonic Corporation BE LIABLE TO ANY PARTY OR ANY PERSON, EXCEPT FOR REPLACEMENT OR REASONABLE MAINTENANCE OF THE PRODUCT, FOR THE CASES, INCLUDING BUT NOT LIMITED TO BELOW:

- ① ANY DAMAGE AND LOSS, INCLUDING WITHOUT LIMITATION, DIRECT OR INDIRECT, SPECIAL, CONSEQUENTIAL OR EXEMPLARY, ARISING OUT OF OR RELATING TO THE PRODUCT;
- ② PERSONAL INJURY OR ANY DAMAGE CAUSED BY INAPPROPRIATE USE OR NEGLIGENT OPERATION OF THE USER;
- ③ UNAUTHORIZED DISASSEMBLE, REPAIR OR MODIFICATION OF THE PRODUCT BY THE USER;
- ④ INCONVENIENCE OR ANY LOSS ARISING WHEN IMAGES ARE NOT DISPLAYED, DUE TO ANY REASON OR CAUSE INCLUDING ANY FAILURE OR PROBLEM OF THE PRODUCT;
- ⑤ ANY PROBLEM, CONSEQUENTIAL INCONVENIENCE, OR LOSS OR DAMAGE, ARISING OUT OF THE SYSTEM COMBINED BY THE DEVICES OF THIRD PARTY;
- ⑥ ANY INCONVENIENCE, DAMAGES OR LOSSES RESULTING FROM ACCIDENTS CAUSED BY AN INADEQUATE INSTALLATION METHOD OR ANY FACTORS OTHER THAN A DEFECT IN THE PRODUCT ITSELF;
- ⑦ LOSS OF REGISTERED DATA CAUSED BY ANY FAILURE;
- ⑧ ANY DAMAGE OR CLAIMS DUE TO LOSS OR LEAKAGE OF IMAGE DATA OR SETTING DATA SAVED ON THIS UNIT OR ON A MEMORY CARD OR COMPUTER.

■ Network security

The unit also has functions which are used when it is connected to a network. Using the unit when it has been connected to a network may possibly give rise to the following issues.

- ① Leakage or theft of information through this unit
- ② Use of this unit for illegal operations by persons with malicious intent
- ③ Interference with or stoppage of this unit by persons with malicious intent

It is your responsibility to take precautions such as those described below to protect yourself against the above network security risks.

- Use this unit in a network secured by a firewall, etc.
- If this unit is connected to a network that includes computers, make sure that the system is not infected by computer viruses or other malicious entities (using a regularly updated antivirus program, anti-spyware program, etc.).

The following points should be borne in mind as well.

- Use with the same segment is recommended for the equipment which is connected to the unit.
If the unit is connected to equipment whose segments are different, events dependent upon the settings inherent to the network equipment, for instance, may occur so thoroughly check the connections with the equipment to which the unit will be connected prior to the start of operation.
- Do not choose an installation location where the unit, cables and other parts will be easily damaged.

Precautions for use

● Handle carefully.

Do not drop the product, or subject it to strong shock or vibration.

Do not carry or move the product by the fader lever. This is important to prevent malfunctioning or accidents.

● Use the product in an ambient temperature of 0 °C to 40 °C (32 °F to 104 °F).

Avoid using the product at a cold place below 0 °C (32 °F) or at a hot place above 40 °C (104 °F) because extremely low or high temperature will adversely affect the parts inside.

● Power off before connecting or disconnecting cables.

Before plugging or unplugging the cables, be sure to switch power off.

● Avoid humidity and dust.

Avoid using the product at a humid, dusty place because much humidity and dust will cause damage to the parts inside.

● Maintenance

Turn off the unit's power and wipe the product using a dry cloth. To remove stubborn dirt, dip a cloth into a diluted solution of kitchen detergent (neutral), wring it out well, and wipe the product gently. Then, after wiping the product with a moist cloth, wipe it again with a dry cloth.

Caution

- Avoid using benzine, paint thinners and other volatile fluids.
- If a chemical cleaning cloth is to be used, carefully read through the precautions for its use.

● Precaution to be observed during production

This product's image switching and image effect functions can be used to produce images which flicker rapidly or images which change rapidly.

However, bear in mind when using these functions in production that the kinds of images produced may have an adverse effect on the viewer's physical well-being.

● Built-in display (LCD monitor)

Leaving the built-in display on with the same image over a long period of time may result in temporary afterimage (burn-in).

Such afterimages are usually resolved when ordinary moving images are displayed for a while.

The liquid crystal parts are highly precise with 99.99% of the pixels effective. This leaves less than 0.01% of pixels that may not light or may remain on all the time.

These phenomena are normal and will have no effect on the images you shoot.

Condensation may form if you use the unit where temperatures fluctuate. Wipe dry with a soft, dry cloth.

When the unit has completely cooled down, the display on the LCD monitor appears slightly darker than usual immediately after the power has been turned on. Once the internal temperature of the unit rises, the display returns to the normal brightness.

● When the product is to be discarded

When the product is to be discarded at the end of its service life, ask a specialized contractor to dispose of it properly in order to protect the environment.

● Concerning the consumable parts

Cooling fan:

This is a consumable part.

As a general rule, replace it every 5 years or so (when the unit has been operated for 15 hours a day).

The period when the consumable parts need to be replaced will differ depending on the operating conditions.

When the time comes to replace one of these parts, be absolutely sure to ask your dealer to do the job.

Installation precautions

● In addition to heeding the points presented in the “Read this first!”, observe the following precautions as well.

Connecting the power supply

- Be absolutely sure to use only the power cable supplied with the unit.
- The power cable supplied with the unit has a 3-pin plug with a grounding terminal.

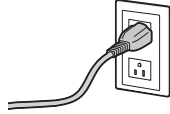

Connect to a 3-pin AC outlet which is equipped with a grounding terminal.

- Be absolutely sure to connect the ground terminal (SIGNAL GND) at the rear of the unit to the system ground.
- When the unit is not going to be used for a prolonged period of time, turn off its power, and disconnect the power plug from the AC outlet.

Handle carefully!

- Dropping the unit or subjecting it to strong impact or vibration may cause trouble and/or malfunctioning.

Do not allow any foreign objects to enter inside the unit!

- Allowing water, metal items, scraps of food or other foreign objects inside the unit may cause a fire and/or electric shocks.

Choosing the best installation location

- Install the unit on a sufficiently strong, stable and level surface for use.
- Ensure a space of at least 100 mm (3-15/16 inches) around the unit's vents to avoid obstructing ventilation. In particular, ensure sufficient space between ventilation and wiring when using mounted in a panel or table.
- Do not install the unit in a manner in which its cables and other accessories can be easily damaged.
- Avoid installing the unit where it will be exposed to direct sunlight or to the hot air that is blown out from other products.
- Installing the unit in a very humid, dusty or vibration-prone location may give rise to trouble.

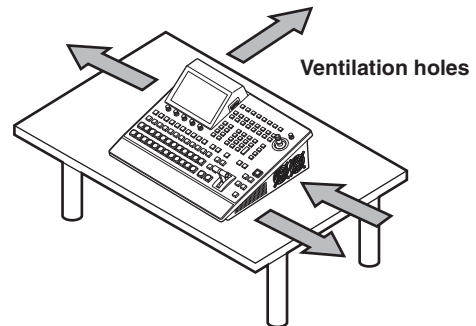

Features

Compact design, abundant inputs and outputs

- Despite its compact size, it comes with eight SDI inputs, two HDMI inputs, five SDI outputs and two HDMI outputs.
- Along with the background transitions using cuts, mixes, and wipes, the unit is also equipped with five keyers including two channels for chroma keys and two channels of PinP.
- The two multi view display functions enable a single monitor to be divided so that it can display a maximum of 16 videos.
- Input/output accommodates 4K, 3G, and HD-SDI as standards, and each input is equipped with a frame synchronizer (FS).
- There are two option slots that combine input and output functionality, and the addition of optional input units expands input capabilities to a maximum of 16 inputs, and the addition of optional output units expands output capabilities to a maximum of 13 outputs.

Supports multiple formats

- The following signal formats are supported:

4K formats: 2160×59.94p, 2160×50p, 2160×29.97p, 2160×25p, 2160×24p, 2160×23.98p
2K formats: 1080×59.94P, 1080×50P, 1080×29.97Psf, 1080×25Psf, 1080×24Psf, 1080×23.98Psf, 1080×59.94i, 1080×50i, 1080×29.97p, 1080×25p, 1080×24p, 1080×23.98p
HD formats: 720×59.94P, 720×50P

- Supports a multiple number of 4K, 2K and HD formats.
- Compatible with a variety of interfaces, such as 12G-SDI, 3G-SDI, 1.5G-SDI and HDMI.
- There are three option slots (with one of these planned to be available in the future) in the compact chassis of this all-in-one unit.
- The standard eight SDI inputs can be expanded to a maximum of 16 inputs; the standard two HDMI inputs can be expanded to a maximum of eight inputs.
- The standard five SDI outputs can be expanded to a maximum of 13 outputs; the standard two HDMI outputs can be expanded to a maximum of eight outputs.
- Equipped with five keyers to enable an abundance of video effects.
- Equipped with features such as up/down converters, HDR/SDR converters, and ITU-R BT.2020/BT.709 converters.
- Equipped with four AUX BUS. The AUX1 and AUX2 both have MIX transition functions, and additionally DSK1 and 2 can be assigned.
- Fitted with a remote camera controller function that is able to control a maximum of 16 Panasonic 4K/HD integrated cameras.
- High-quality chroma keys enabled with the Primatte® algorithm.
- Video memory (2 systems each for still images and videos (1 system only in 4K mode, however)) can be recorded and played back with key signals attached.
- Equipped with a shot memory and event memory function.
- Compatible with SD memory cards, SDHC memory cards, and SDXC memory cards.
- Built-in 7-inch color display.

Optional units that make possible a variety of expansion functions to suit any application

- SDI Input Unit AV-UHS5M1
Has four 3G or 12G-SDI inputs supporting frame synchronizers, up-conversion, color correction, SDR/HDR conversion, and ITU-R BT.2020/BT.709 conversion.
- SDI Output Unit AV-UHS5M2
Has four 3G or 12G-SDI outputs supporting down-conversion, HDR/SDR conversion, and ITU-R BT.2020/BT.709 conversion.
- HDMI Input Unit AV-UHS5M3
Three HDMI2.0 inputs
There is a scaler function in each of the channels.
- HDMI Output Unit AV-UHS5M4
Three HDMI2.0 outputs
There is a scaler function in each of the channels.
- 4K DVE Unit AV-UHS5M5
Equipped with DVE function for the 4K mode. (one BKGD and one keyer)

Accessories

Check that the following accessories are present and accounted for.

- After removing the product from its container, dispose of the power cable cap (if supplied) and packing materials in an appropriate manner.

Power cable for AV-UHS500P 1



Power cable for AV-UHS500E 3

- For U.K. and Saudi Arabia
- For Continental Europe, etc.
- For India only

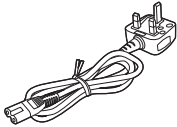

- This product is equipped with 3 types of AC mains cable. Appropriate mains cable must be used in each local area, since the other type of mains cable is not suitable.

■ Sold separately

Optional units

Model number	Unit	Function	Supported slots	
			SLOT A	SLOT B
AV-UHS5M1	SDI Input Unit	3G/12G-SDI input × 4 lines	✓	✓
AV-UHS5M2	SDI Output Unit	3G/12G-SDI output × 4 lines	✓	✓
AV-UHS5M3	HDMI Input Unit	HDMI input × 3 lines	✓	✓
AV-UHS5M4	HDMI Output Unit	HDMI output × 3 lines	✓	✓
AV-UHS5M5	4K DVE Unit	BKGD output × 1 line, Keyer output × 1 line,	✓	✓

✓: Supported

Installation and connections (Be sure to ask your dealer.)

■ How to install the optional units

For details, refer to the operating instructions of the optional unit concerned.

AV-UHS5M1	SLOT A	IN-A1, IN-A2, IN-A3, IN-A4
	SLOT B	IN-B1, IN-B2, IN-B3, IN-B4
AV-UHS5M2	SLOT A	OUT-A1, OUT-A2, OUT-A3, OUT-A4
	SLOT B	OUT-B1, OUT-B2, OUT-B3, OUT-B4
AV-UHS5M3	SLOT A	IN-A1, IN-A2, IN-A3
	SLOT B	IN-B1, IN-B2, IN-B3
AV-UHS5M4	SLOT A	OUT-A1, OUT-A2, OUT-A3
	SLOT B	OUT-B1, OUT-B2, OUT-B3

Notes

- Before installing or removing optional units, turn off the power, and disconnect the power plug.
- Before coming into physical contact with optional units, touch your hand to metal that has been grounded to discharge the static electricity in your body.
A safe way to proceed is to wear an anti-static wrist strap.
Optional units may be damaged if you touch them with static still in your body.
- Avoid damage to optional units by not dropping or subjecting to strong shocks or vibrations.
- After removing optional units, be absolutely sure to attach the blank panel.
- When installing or removing optional units, take care not to hurt yourself on the edges or metal parts.

Installation and connections (Be sure to ask your dealer.)

- ① Turn off the power of the unit, and disconnect the power cable.
- ② Loosen the four screws of SLOT A or SLOT B at the back of the unit, and remove the blank panel.

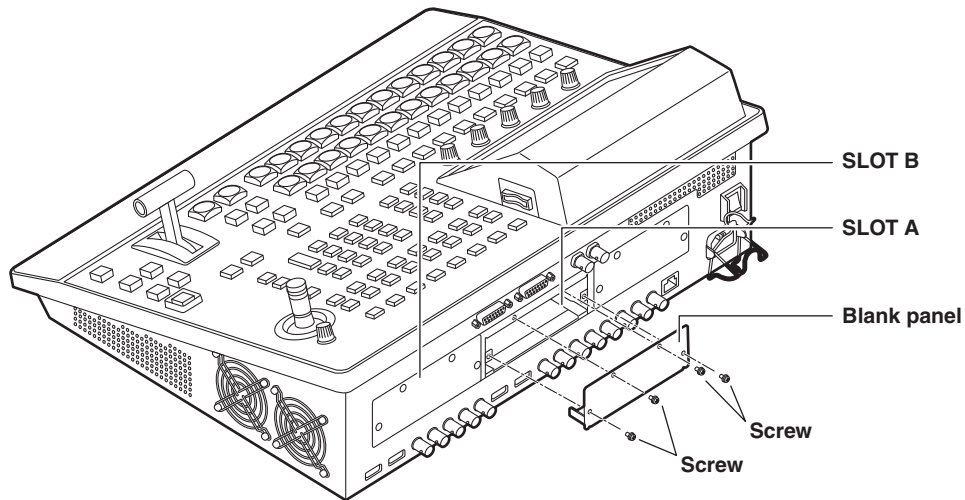

- ③ Align the optional unit with the guide rails, and insert it slowly. Insert it until it will go no further. Take care not to exert excessive force while doing this since that may damage the connector inside.
- ④ Mount the optional unit in place using the four screws.
Clamping torque: 0.7 N•m

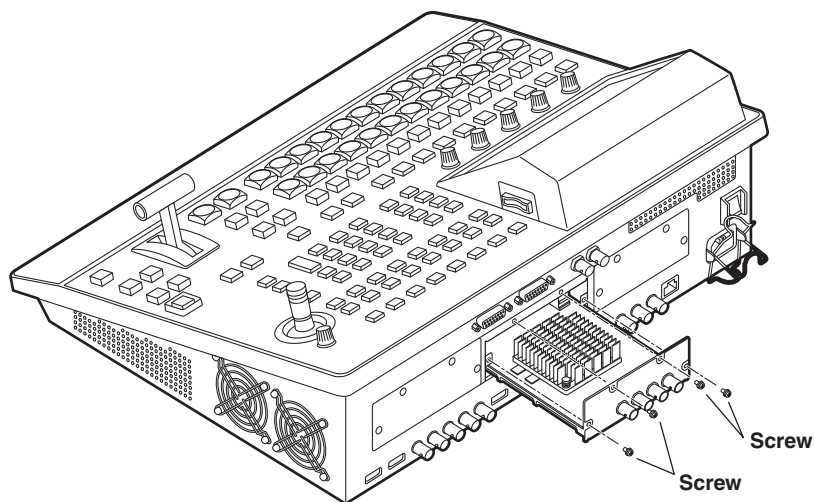

- ⑤ After connecting the necessary cables, plug the power cable into the power outlet, and turn on the power.

Parts and their functions

Control panel

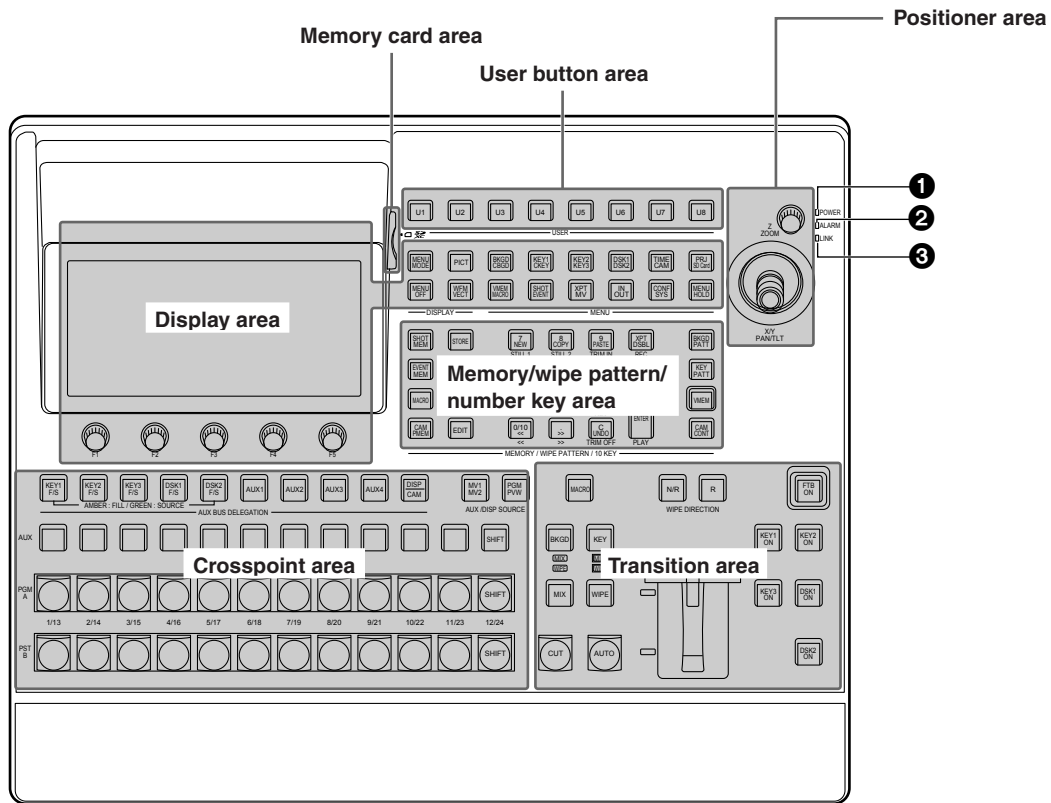

1 POWER indicator [POWER]

This indicator lights when the power switch (43) on the rear panel is set to ON while power is supplied to the AC power input socket (45).

2 ALARM indicator [ALARM]

This indicator lights up when any of the following types of trouble has occurred.

- When the cooling fan has stopped operating
- When something is wrong with the power supply (a drop in the voltage)
- When high temperatures are reached inside the unit

When any of these events has occurred, an alarm message is displayed on the built-in display.

When an alarm has occurred, details of the trouble concerned can be checked by selecting the System menu followed by the Alarm sub menu.

The alarm information can be output from the TALLY/GPI connector (48) on the rear panel to an external device.

For further details, refer to "Alarm message".

When an alarm has occurred, stop using the unit immediately, and be absolutely sure to contact your dealer.

Continuing to use the unit even after an alarm has occurred could damage the unit.

3 LINK indicator [LINK]

Illuminates when this unit and an external device are linked.

Refer to the operating instructions for the external device for settings on the external device.

Parts and their functions

Crosspoint area

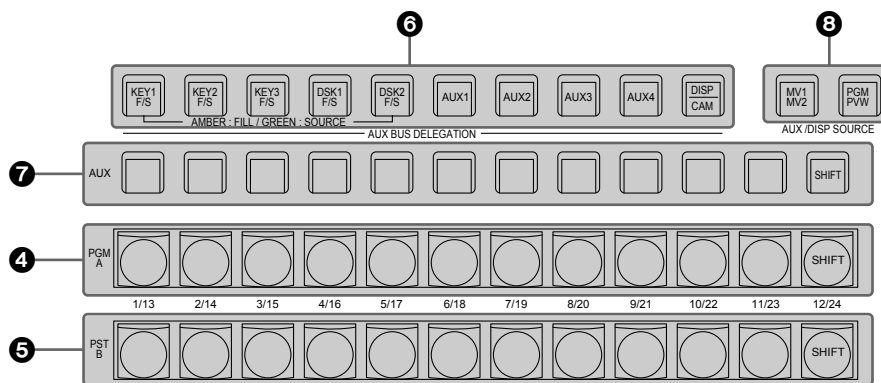

4 PGM/A bus crosspoint buttons

[PGM/A 1 to 12]

These are used to select the PGM/A bus video signals. Buttons 1 to 24 can be selected using the [SHIFT] button. Refer to “Selecting the bus using the SHIFT function”.

“A/B”, “PGM-A/PST-B” or “PGM-B/PST-A” can be selected as the Bus Mode item by selecting the Config menu following by the Operate sub menu.

Refer to “Selecting the bus mode”.

When one of the crosspoint buttons (4, 5, 7) is held down, the name of the input material and the number of the crosspoint button are displayed.

5 PST/B bus crosspoint buttons

[PST/B 1 to 12]

These are used to select the PST/B bus video signals. Buttons 1 to 24 can be selected using the [SHIFT] button. Refer to “Selecting the bus using the SHIFT function”.

“A/B”, “PGM-A/PST-B” or “PGM-B/PST-A” can be selected as the Bus Mode item by selecting the Config menu following by the Operate sub menu.

Refer to “Selecting the bus mode”.

6 AUX bus selector buttons (AUX BUS DELEGATION)

Select the bus to be operated using the AUX bus crosspoint buttons (7). The selected button lights.

[KEY1 F/S], [KEY2 F/S], [KEY3 F/S]:

This button is used to change the AUX bus crosspoint buttons (7) into the source selector buttons for the key fill buses or key source buses.

Each time it is pressed, the selector button function is switched between the key fill buses and key source buses.

Amber	Key fill buses
Green	Key source buses

[DSK1 F/S], [DSK2 F/S]:

This button is used to change the AUX bus crosspoint buttons (7) into the source selector buttons for the DSK fill buses or DSK source buses.

Each time it is pressed, the selector button function is switched between the DSK fill buses and DSK source buses.

Amber	DSK fill buses
Green	DSK source buses

[AUX1] to [AUX4]:

These buttons are used to change the AUX bus crosspoint buttons (7) into the selector buttons for the sources of the AUX buses.

[DISP/CAM] (built-in display/CAM):

When the built-in display is selected, this switches the AUX crosspoint buttons (7) to DISP bus (the images displayed on the built-in display) source selector buttons. When CAM is selected this switches the AUX crosspoint buttons (7) to CAM source selector buttons.

The selection switches between built-in display and CAM each time you press the button.

Amber	Built-in display selected
Green	CAM selected

7 AUX bus crosspoint buttons

These buttons are used to select the source of the bus which was selected by the AUX bus selector button (6). Buttons 1 to 24 can be selected using the [SHIFT] button. Refer to “Selecting the bus using the SHIFT function”.

8 Dedicated crosspoint buttons for the AUX/DISP bus (AUX/DISP SOURCE)

While the [AUX1] to [AUX4] AUX bus selector buttons (6) are illuminated, these select AUX bus sources.

While the [DISP/CAM] AUX bus selector button (6) is illuminated, it selects DISP bus sources.

The buttons that are pressed turn amber.

[MV1/MV2]:

Selects either multi view display signal 1 or signal 2 for the AUX bus or the DISP bus.

Switching between multi view display signal 1 and 2 is done with the [SHIFT] button (7).

[PGM/PVW]:

Selects either the PGM signal or the PVW signal for the AUX bus or the DISP bus.

Switching between the PGM signal and the PVW signal is done with the [SHIFT] button (7).

Parts and their functions

Memory/wipe pattern/number key area

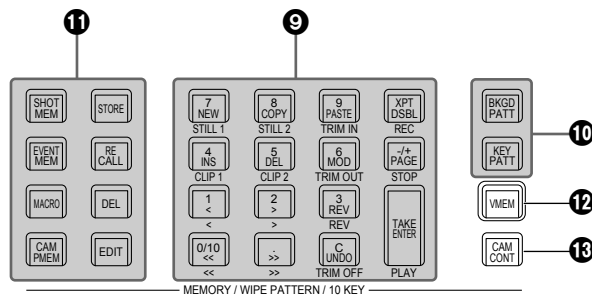

9 Number keys

When the following buttons are pressed and lit, they serve as buttons for executing their corresponding functions.

10 BKGD, KEY pattern selector buttons	[BKGD PATT] [KEY PATT]
11 Memory operation buttons	[SHOT MEM] [EVENT MEM] [MACRO] [CAM PMEM]
12 Video memory operation button	[VMEM]

10 BKGD, KEY pattern selector buttons [BKGD PATT], [KEY PATT]

When the [BKGD PATT] button is pressed and lit, the wipe patterns for the background transitions can be selected using the number keys.

When the [KEY PATT] button is pressed and lit, the wipe patterns for the key transitions can be selected using the number keys.

When both the [BKGD PATT] and [KEY PATT] buttons are lit, the pattern selection menu is displayed on the built-in display.

When the [F1] (33) is rotated, the pattern page is changed.
Refer to "Wipe".

11 Memory operation buttons

[SHOT MEM], [EVENT MEM], [MACRO], [CAM PMEM]:

These buttons are used to select the memory type. The number keys (1 to 10) are used to carry out operations and register and call settings. The [CAM PMEM] button is also used with the ROI PMEM function.

Refer to "ROI function".

[STORE]:

Press this to register data in the memory.

[RECALL]:

Press this to recall data from the memory.

[DEL]:

Press this to delete data in the memory.

[EDIT]:

Press this to edit the event memory/macro memory.

Refer to "Memory".

12 Video memory operation button [VMEM]

When the [VMEM] button is pressed and lit, video memory operations such as recording and playback can be performed using the number keys.

Refer to "Video memories".

When the [VMEM] button has been pressed to turn it green, you can manage the internal storage for the video memory.

13 Camera control button [CAM CONT]

Controls connected remote cameras.

The positioner (34) and display mode buttons (30) are used to control.

The [CAM CONT] button can also be used to control the extraction range for the ROI function.

Refer to "ROI function".

Parts and their functions

User button area

14 User buttons (USER BUTTON) [U1 to U8]

These are used to assign some functions of the menu settings to the [U1] to [U8] buttons on the Config menu.

☞ Refer to “Setting the user buttons”.

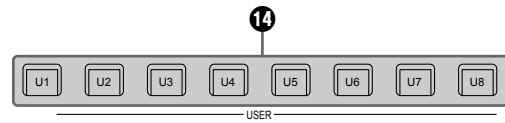

Transition area

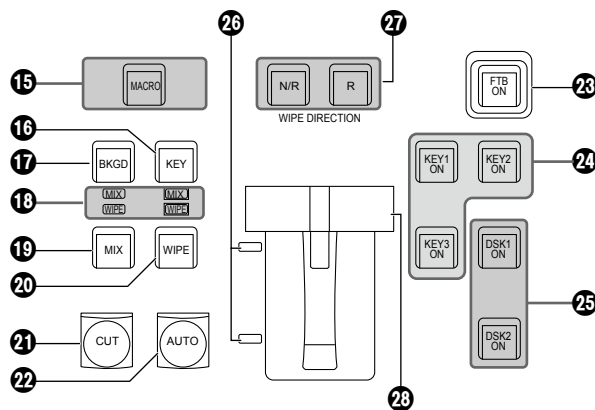

15 [MACRO] button

This executes the Macro memory set in XPT with Macro Assign in the menus.

The [AUX] button, in which Macro memory is set with Macro Assign in the menus, turns green when the [MACRO] button is selected and turns amber.

The registered Macro memory is executed when the illuminated button is selected.

16 [KEY] button

This executes the KEY1 transition when the [CUT] button (21), [AUTO] button (22) or fader lever (26) has been operated.

When the [KEY] button is pressed and it is selected, its indicator lights in amber.

If the [BKGD] button (17) is now pressed, the indicator goes off, and the de-selected status is established.

When the [BKGD] button (17) and [KEY] button are pressed at the same time, both buttons are set to the selected status.

17 [BKGD] button

This executes the background transition when the [CUT] button (21), [AUTO] button (22) or fader lever (26) has been operated.

When the [BKGD] button is pressed and it is selected, its indicator lights in amber.

If the [KEY] button (16) is now pressed, the indicator goes off, and the de-selected status is established.

When the [BKGD] button and [KEY] button (16) are pressed at the same time, both buttons are set to the selected status.

18 MIX, WIPE selection status LEDs

These light up to indicate whether MIX or WIPE has been selected when background transitions or key transitions are executed.

19 [MIX] button

This is used to switch the A and B bus images while making them overlap.

During the transition, the A and B bus output total is kept at 100%.

When the [MIX] button is pressed and it is selected, its indicator lights in amber.

If the [WIPE] button (20) is now pressed, it goes off, and the de-selected status is established.

Parts and their functions

20 [WIPE] button

This is used to execute the transition using the pattern selected by the number key (9).

When the [WIPE] button is pressed and it is selected, its indicator lights in amber.

If the [MIX] button (19) is now pressed, it goes off, and the de-selected status is established.

21 [CUT] button

This button is used to execute transitions instantly.

Its indicator lights in amber during a transition, and it goes off when the transition is completed.

Only KEY1 is enabled when KEY is set.

22 [AUTO] button

This is used to automatically execute transitions (auto transition) using the transition time which has been set on the Time menu.

During auto transition its indicator lights in amber.

When the button is pressed again during auto transition, the auto transition operation is suspended, and the indicator lights in green. When it is pressed again while auto transition is suspended, the remaining transition is executed.

The indicator goes off when auto transition is completed.

When the [AUTO] button is pressed while the fader lever (28) is at an interim setting, the transition is executed in the time remaining from the interim setting.

Only KEY1 is enabled when KEY is set.

23 [FTB ON] button

This button is used to execute fade-out to a black screen/white screen/Still/Clip/color background screen or fade-in from a black screen/white screen/Still/Clip/color background screen for the transition time which has been set on the Time menu.

24 [KEY1 ON], [KEY2 ON], [KEY3 ON] button

This button is used to execute the key transition for the transition time which has been set on the Time menu.

25 [DSK1 ON], [DSK2 ON] button

This button is used to execute fade-in or fade-out of downstream key for the transition time which has been set on the Time menu.

26 Bus tally LEDs

These indicate the output statuses of the A bus and B bus. The LED corresponding to the bus whose program signals (PGM) are being output lights.

27 Wipe direction selection buttons (WIPE DIRECTION) [N/R], [R]

These buttons are used to select the direction in which to wipe for executing background transitions.

When the [R] indicator is off:

Wiping proceeds in the normal direction.

When the [R] indicator is lit:

Wiping proceeds in the reverse direction.

When the [N/R] indicator is lit:

The normal direction is replaced with the reverse direction (or vice versa) when the transition is completed.

(The lit and extinguished statuses of the [R] button are also switched in line with the direction of the wiping.)

28 Fader lever

This is used to execute background or KEY1 transitions.

When it is moved as far as it will go, the transition is completed. When it has been operated during auto transition, auto transition will be switched to manual operation as soon as the fader position overtakes the amount of the transition being executed.

Parts and their functions

Display area

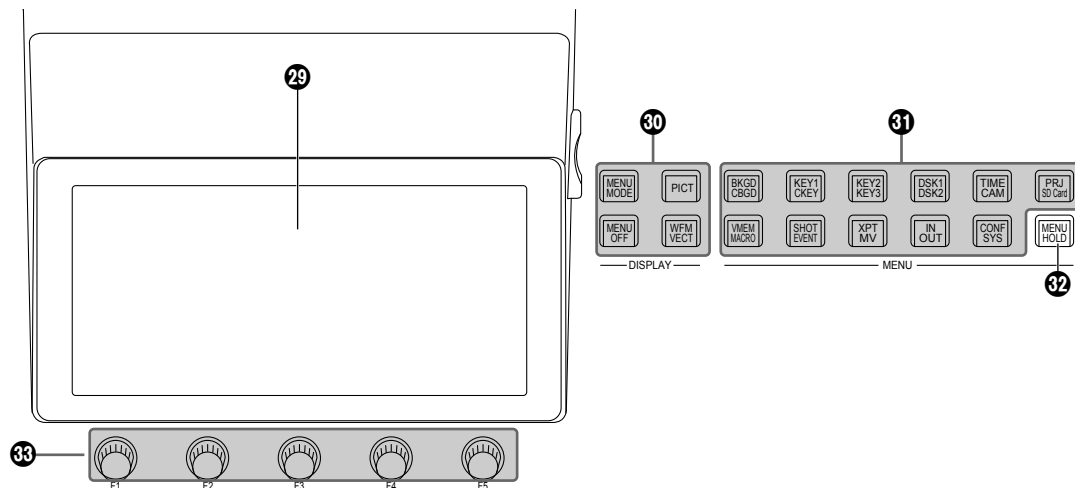

29 Built-in display

The images, waveforms and menus are displayed by operating the display mode buttons (30), menu selection buttons (31) and [CAM CONT] button (13). To display images on the built-in display, press the [DISP/CAM] button of the AUX bus selector buttons (6) so it turns amber. The source images selected with the DISP bus can also be displayed. To check the camera input, select the [CAM CONT] button (13), and while it is displayed in amber, select the [DISP/CAM] button of the AUX bus selector buttons (6) to display it in green, and select the XPT of the AUX to which the camera you want to check is connected.

- 1 line of menu display and full-screen image display



30 Display mode buttons (DISPLAY)

These buttons are used to select what is to be displayed on the built-in display.

[MENU MODE]:

Each time this button is pressed, the menu mode is switched.

- Menu display/Subscreen/Image display

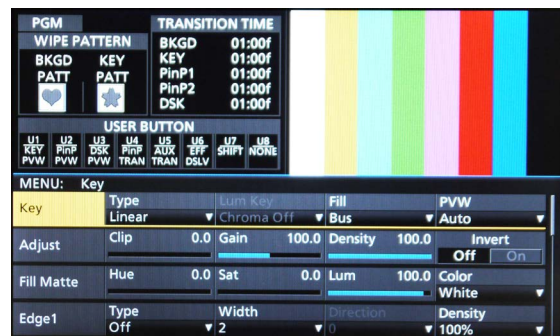

- Menu-only display



Parts and their functions

- Menu display/WFM display (or VECTOR display)/Image display

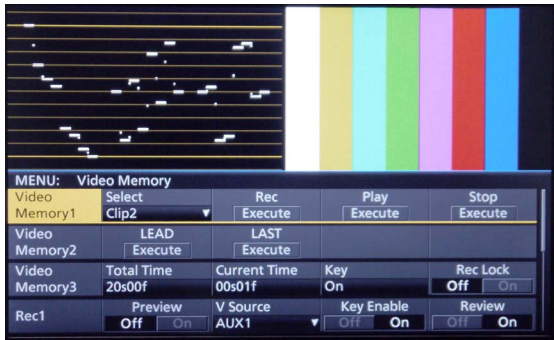

The image display and the WFM display (or VECTOR display) displayed in the upper portion of the built-in display can be switched by pressing the [PICT] button or the [WFM/VECT] button.

[MENU OFF]:

This button clears the menu display and switches to the image-only display.

[PICT]:

When this button is pressed and lit, images are displayed on the built-in display.

[WFM/VECT]:

When this button is pressed and lit, waveforms (WFM: waveform monitor) or vectors (VECTOR: vectorscope) are displayed on the built-in display. Each time the button is pressed, the display switches between WFM and VECTOR.

- WFM (waveform monitor) display

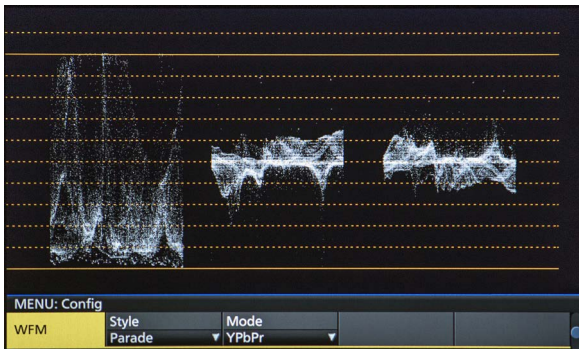

- VECTOR (vectorscope) display



31 Menu selection buttons (MENU)

Each time one of these buttons is pressed, the menu of the function indicated at the top or bottom of the button is selected.

The button of a selected menu lights up in amber.

32 [MENU HOLD] button

This button is used to keep a menu on the display.

When it is pressed while a menu is displayed, the menu displayed will not be switched to another menu even when one of the menu selection buttons is pressed.

While the [MENU HOLD] button is pressed, the [MENU HOLD] button lights up in amber.

33 Rotary encoders [F1] to [F5]

These are used to set the parameters which are displayed on the built-in display.

☞ Refer to "Basic menu operations".

Parts and their functions

Positioner area

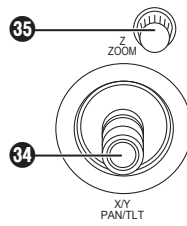

34 Positioner (POSITIONER) [X/Y] [PAN/TILT]

These are used when performing the settings below.

- Key PinP, DSK PinP position settings
- Wipe start position setting

Target patterns:
 WIPE1: 5
 WIPE2: 4, 5, 6, 7
 SQ1: 5
 SQ2: 4, 5, 6, 7
 Refer to "Wipe".

- Flying key position setting
- Chroma key marker position setting
- When entering characters
- When making settings using the keyboard screen
- Pan and tilt control for a remote camera

In each case, the settings take effect only when the following menu items have been selected.

Note

During the time it takes for the unit to start up after its power is turned on, the unit detects the positions of the positioners and sets them to their center positions. Do not touch the positioners until the unit has started up.

35 Rotary encoder [Z] [ZOOM]

This is used to set the PinP size, flying key size or to select the chroma key area.

Also used to control the zoom on a remote camera.

In each case, the settings take effect only when the following menu items have been selected.

It is also used for settings using the keyboard screen.

	Positioner	Rotary encoder		Valid menu
	X/Y	Z	Switch	
Key PinP, DSK PinP	Position adjustments	Size adjustments (size increased by rotating the encoder clockwise and reduced by rotating it counterclockwise)	Hold switch down to restore initial values (X/Y, Z).	PinP Position
WIPE (BKGD)	Start position adjustments	—	Hold switch down to restore initial values (X/Y).	Background/Position
WIPE (KEY)	Start position adjustments	—	Hold switch down to restore initial values (X/Y).	Key/Position
Chroma key	Selection position adjustments	Selected area size adjustments (size increased by rotating the encoder clockwise and reduced by rotating it counterclockwise)	Execute sampling Hold switch down to restore size to initial values.	Chroma Key
Flying key	Position adjustments	Size adjustments (size increased by rotating the encoder clockwise and reduced by rotating it counterclockwise)	Hold switch down to restore initial values (X/Y, Z).	Key1: Flying Key

- These are available for PAN/TILT or ZOOM control of the camera that is registered in Camera Information when the [CAM CONT] button (Ⓜ) turns amber or while the [CAM PMEM] screen is being displayed on the built-in display.
- In the ROI mode, while the [ROI PMEM] screen is displayed on the built-in display, these can be used to set the Pos-X, Pos-Y, Size, and Pos-Speed for the input selected with the CAM bus.

Parts and their functions

Memory card area

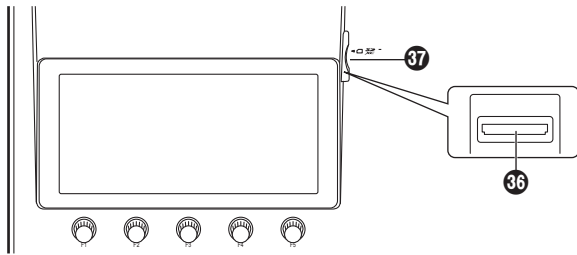

36 Memory card slot

Insert an SD memory card (purchased separately), an SDHC memory card (purchased separately) or an SDXC memory card (purchased separately) into this slot.

37 Memory card access LED

This LED lights while the data on the memory card is being accessed.

Do not turn off the unit's power or eject the memory card while the access LED is lit.

Doing so can damage the data on the memory card.

● Concerning memory cards

Memory cards used with the unit should conform to SD, SDHC or SDXC standards.

Be sure to format cards using the unit.

Use memory cards formatted with FAT. (NTFS formatted memory cards cannot be recognized.)

Panasonic memory cards with the following capacities can be used with the unit:

SD (from 8 MB to 2 GB)

SDHC (from 4 GB to 32 GB)

SDXC (from 64 GB to 128 GB)

For the latest information not available in the Operating Instructions, visit the following Web sites.

<https://pro-av.panasonic.net/>

- Memory cards must not be used or stored in an environment where they may be
 - Exposed to high temperatures/humidities;
 - Exposed to water droplets; or
 - Electrically charged.

Parts and their functions

Rear panel area

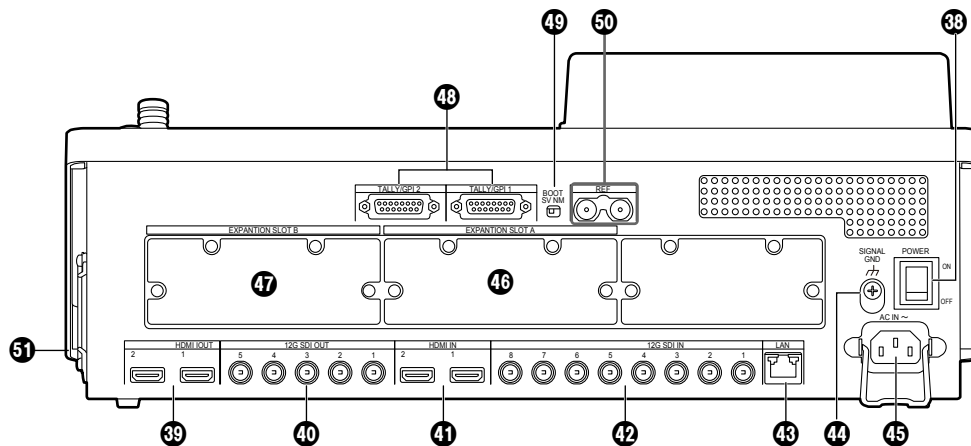

38 Power switch [POWER]

When the power switch is turned on, the POWER indicator (1) lights up, and the unit can be operated.

39 HDMI output connectors [HDMI OUT 1, 2]

Connect to external devices with an HDMI cable.

40 SDI signal output connectors [12G SDI OUT 1 to 5]

Assignable with menus

41 HDMI input connectors [HDMI IN 1, 2]

Connect to external devices with an HDMI cable.

42 SDI signal input connectors [12G SDI IN 1 to 8]

12G SDI IN 1 to 12G SDI IN 4 can use the up-converter function.

43 LAN connector [LAN] (RJ-45) (1000Base-TX)

Refer to "External interfaces".

44 Ground connector [SIGNAL GND]

Connect to the system's earth ground.

45 AC power input socket [AC IN ~] (AC 100 V to 240 V, 50/60 Hz)

Connect one end of the supplied power cable to this socket and the other end to the AC outlet.

The supplied power cable comes with a 3-pin power plug. Be absolutely sure to plug it into a 3-point power outlet as the power source in order to earth the unit securely.

If a 3-point power outlet is not available for this connection, be absolutely sure to consult your dealer.

46 Option slot SLOT A [EXPANSION SLOT A]

47 Option slot SLOT B [EXPANSION SLOT B]

Each of these is an input/output option slot.

A SDI input unit, HDMI output unit or other optional unit can be installed in these slots.

For details, refer to "How to install the optional units" and the operating instructions of the unit concerned.

48 TALLY/GPI input/output connectors [TALLY/GPI 1, TALLY/GPI 2] (D-sub 15-pin, female, inch screw)

Refer to "External interfaces".

49 BOOT switch [BOOT SV NM]

This switch is used for maintenance purposes.

For normal operations, select the "NM" (normal) position.

50 Reference input connector/BB output connector [REF]

Loop-through output in the external sync mode.

If the loop-through output is not going to be used, provide a 75-ohm termination.

BB signals output from both connectors in the internal sync mode.

51 Cooling fan

Preparations

Turning the unit's power on and off

● Turning on the power

1 Set the power switch to the ON position.

When power is supplied to the unit, the POWER indicator lights.

- ① After several seconds, the crosspoint buttons light up.
- ② Several seconds after the crosspoint buttons have lit up, the opening screen appears on the built-in display. At this point, it becomes possible to select the crosspoints.



- ③ Menu operations can be performed when the opening screen is cleared.

● Turning off the power

1 Set the power switch to the OFF position.

The unit's power is turned off, and the POWER indicator goes off.

Preparations

Basic menu operations

This section describes the basic operations of the menus which are displayed on the built-in display. For the menu configuration, refer to “Setting menu table”.

Menu configuration and operations

1 Press the [MENU MODE] button to show the menu on the built-in display.

☞ Refer to “Display area”.

2 Select the menu for each function using the menu selection buttons (MENU) that corresponds to the function concerned.

Each time the button is pressed, the menu of the function displayed at the top of the button and the menu of the function displayed at the bottom are switched.

The button of a selected menu lights up in amber.

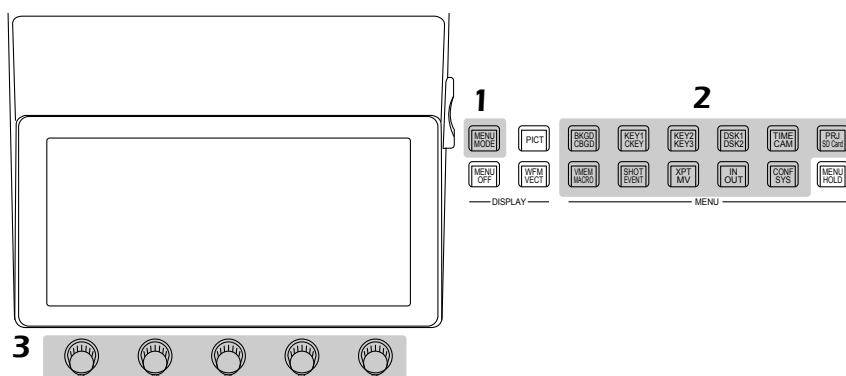

3 Use the rotary encoders [F1] to [F5] to select more detailed settings.

[F1] : Turn this rotary encoder to select the sub menu.

[F2] to [F5] : Use (press or turn) these rotary encoders to set the parameters.

For further details, refer to the next page.

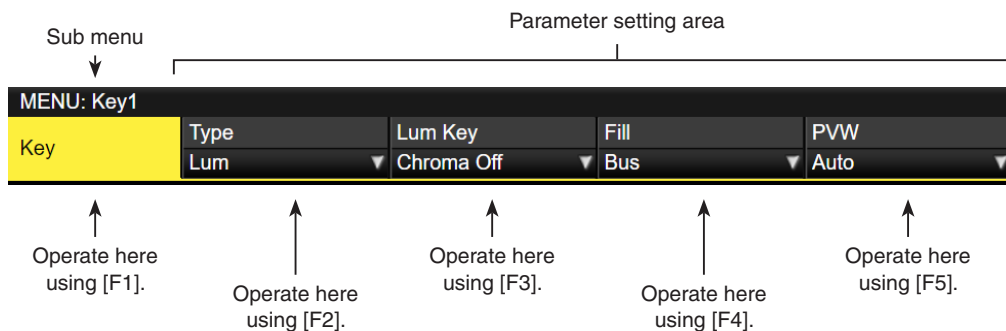

- The Input and Output menus will differ depending on whether optional units have been installed in the unit.

Preparations

List box:

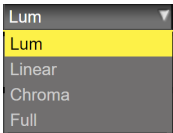

- ① Press [F2] to [F5] to display the list box.
- ② Turn [F2] to [F5] clockwise or counterclockwise to select the setting.
 - The setting of an item whose selected setting does not blink will be reflected in the unit as soon as it has been selected.
 - The setting of an item whose selected setting blinks is reflected in the unit by pressing [F2] to [F5].
- ③ Press [F2] to [F5] again to close the list box.

Selector button:



When a rotary encoder [F2] to [F5] is pressed, the setting is switched between “On” and “Off.”

Execution buttons:



When a rotary encoder [F2] to [F5] is pressed, the corresponding function is executed.

Numeric value input box:

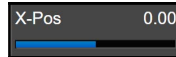



Turn a rotary encoder [F2] to [F5] to change the numeric value.

When a rotary encoder [F2] to [F5] is held down, the numeric value is returned to its initial value.

A numeric value bar is displayed and its display is linked to the numeric value.

Inputting numeric values using the number keys

- ① Press [F2] to [F5] to establish the mode in which numeric values can be input using the number keys.
 - Use the  button to input the decimal point. If a numeric value has a decimal point which is not input, it will be treated as an integer, and its decimal places will be set to zero (“0”).
 - Press the  button to switch the numeric value between a positive and negative value. Each time this button is pressed, the numeric value is switched from positive to negative (or vice versa).
 - If the  button is pressed when a numeric value has been input, the numeric value will be returned to the value prior to the change.
- ② Input the numeric values using the number keys, and press the [TAKE ENTER] button.

The values which have been input are entered and reflected in the unit.

 - When a numeric value is input using the number keys and a rotary encoder from [F1] to [F5] is operated, the input value is cleared, and the numeric value prior to input is restored.
 - When a numeric value outside the setting range is input, the value is invalid and the numeric value prior to input is restored.

Character input box:

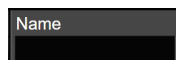

When a rotary encoder [F2] to [F5] is pressed, the keyboard screen is displayed.

Use rotary encoders [F1] to [F5] or positioner to input the characters.

 Refer to “Keyboard screen operations”.

Preparations

Keyboard screen operations

When a name such as the name of the input signal material, name of the memory or name of the data to be saved on an memory card is to be changed, display the keyboard screen, and input the characters.

When the rotary encoder [F2] to [F5] that corresponds to the item (character input box) whose name is to be changed is pressed, the keyboard screen appears on the built-in display.

Character input area



When the keyboard screen is displayed, use positioner, [Z] or rotary encoders [F1] to [F5] to input the characters (alphanumerics and symbols).

The character selected is reflected in the character input area.

[F1]: CURSOR

Turn [F1] to move the cursor inside the character input area.

[F2]: SHIFT

When [F2] is pressed, the keyboard display is switched (between upper-case letters, lower-case letters and symbols).

[F3]: CLEAR

When [F3] is pressed, all of the characters in the input area are cleared.

[F4]: OK

When [F4] is pressed, the name which has been input is entered, and reflected in the unit.

At this point, the keyboard screen is cleared, and the original screen is restored.

[F5]: CANCEL

When [F5] is pressed, the name which has been input is canceled.

At this point, the keyboard screen is cleared, and the original screen is restored.

Positioner: POSITION

Move the positioner to move the cursor within the input area.

[Z]: SELECT

Text is selected when [Z] is pressed.

- It is possible to enter numbers with the number keys, delete characters with the [C] button, and confirm the name with the [Enter] button.

Menu delegation function

When the buttons listed below are double-clicked, the specified menu is selected. (The menu delegation function)
The operation corresponding to the button pressed is also executed.

Button	Menu selected
Crosspoint area (AUX bus selector buttons)	
KEY1 F/S	Key menu/Adjust sub menu When the chroma key is selected: Chroma Key menu/Adjust sub menu When PinP is selected: PinP menu/Position sub menu
KEY2 F/S	Key menu/Adjust sub menu
KEY3 F/S	Key menu/Adjust sub menu
DSK1 F/S	DSK menu/Adjust sub menu When the chroma key is selected: Chroma Key menu/Adjust sub menu When PinP is selected: PinP menu/Position sub menu
DSK2 F/S	DSK menu/Adjust sub menu
Transition area	
BKGD	Time menu/BKGD sub menu
KEY	Time menu/Key1 sub menu
WIPE	Background menu/Border sub menu

<Menu delegation setting>

This setting is used to enable (turn on) or disable (turn off) the menu delegation function.

- Press the button to light its indicator, and display the Config menu.
- Use [F1] to display the Operate sub menu.

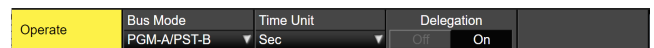

- Use [F4] to set enable or disable for the menu delegation function at the Delegation item.

On	Enable
Off	Disable

Preparations

Setting the system format

One system format (input/output signal) can be selected.

① Press the  button to light its indicator, and display the System menu.

② Use [F1] to display the Format sub menu.

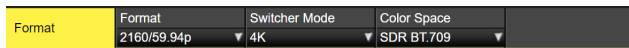

③ Use [F3] to select 4K or 2K in the Switcher Mode item, then press [F3] to confirm the selection.

- When you switch the Switcher Mode of this unit between 4K and 2K, Initial and a restart are executed. Initial means that all of the current settings or video memory are cleared.

④ Use [F2] to select the format in the Format item, then press [F2] to confirm the selection.

- The video memory is cleared completely when the Format of this unit is switched. However, the still image memory (Still) is only cleared when switched to 1080 or 720.

⑤ [Use [F4] to select the color space in the Color Space item, then press [F4] to confirm the selection.

Setting the date and time

The user can set the date and time to be used as the memory card's time stamp.

Be absolutely sure to set them when a memory card is to be used.

Setting the date

① Press the  button to light its indicator, and display the System menu.

② Use [F1] to display the Date sub menu.



③ Use [F2] to set the year using the Year item.

④ Use [F3] to set the month using the Month item.

⑤ Use [F4] to set the day using the Date item.

⑥ Press the [F5] to enter the year/month/day.

⑦ Press [F1] (YES) to save. Press [F5] (NO) to disable.

Setting the time

① On the System menu, use [F1] to display the Time sub menu.



② Use [F2] to set the hour using the Hour item.

③ Use [F3] to set the minutes using the Minute item.

④ Use [F4] to set the seconds using the Second item.

⑤ Press the [F5] to enter the hour/minutes/seconds.

⑥ Press [F1] (YES) to save. Press [F5] (NO) to disable.

The time counts up from when the power is turned on.

About the built-in battery for the date/time

When the time display is "2014/01/01 00:00:00", the built-in battery for the date/time is exhausted.

After recharging the built-in battery for the date/time, set the date and the time.

To recharge the built-in battery for the date/time

Turn the power of the unit on and leave it for approximately 3 hours.

It can keep the clock settings for approximately 6 months.

Basic operations

Background transition

Selecting the bus

Press one of the crosspoint buttons to select the material to be used for the background transition. Depending on the operating status, the button pressed will light in one of two colors.

Lighting in red	When the selected input signals are output to PGM. (However, the indicator lights in amber during FTB operations.)
Lighting in green	When the selected input signals are not output to PGM.

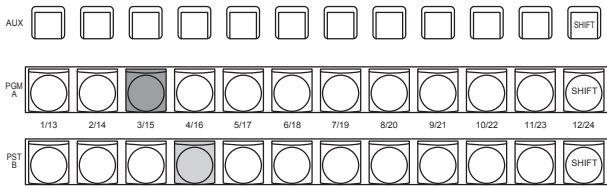

■ Lighting in red
■ Lighting in green

- When the crosspoint buttons are held down, the button numbers and the names of the input materials assigned to the buttons are displayed on the built-in display in the form of a list for as long as the crosspoint buttons remain held down.

XPT:	1	2	3	4	5	6	7	8	9	10	11	12
SIG:	IN1	IN2	SDI IN3	SDI IN4	SDI IN5	SDI IN6	SDI IN7	SDI IN8	CBAR	CBGD 1	CBGD 2	SHIFT
XPT:	13	14	15	16	17	18	19	20	21	22	23	24
SIG:	None	None	None	None	None	None	None	None	None	None	None	SHIFT

Selecting the bus using the SHIFT function

The SHIFT function enables two materials to be allocated — the front material and the rear material — to one button, and the materials to be selected using the [SHIFT] button. A total of 24 materials — front materials (1 to 12) and rear materials (13 to 24) — can be allocated to the three groups of 12 crosspoint buttons whether these buttons are the PGM/A bus crosspoint buttons, PST/B bus crosspoint buttons or AUX bus crosspoint buttons.

There are actually two SHIFT functions: “All SHIFT” for switching all the front materials to the rear materials or vice versa, and “Single SHIFT” for switching the front material of one crosspoint button with its rear material or vice versa. “All SHIFT” works once the SHIFT function has been allocated to one of the user buttons. “Single SHIFT” works once the SHIFT function has been allocated to the No.12 or No.1 crosspoint button of the crosspoint button group concerned by a menu operation.

All SHIFT

All SHIFT is used to switch all the materials of the PGM/A bus crosspoint buttons, PST/B bus crosspoint buttons or AUX bus crosspoint buttons from front materials to rear materials or vice versa.

The user button to which the SHIFT function has been allocated is used to switch between the front materials and rear materials.

- Allocate the SHIFT function to one of the user buttons. (For the method used to allocate this function to the user button, refer to “Setting the user buttons”.)
- Each time the [SHIFT] button (user button) is pressed, the front materials are switched to the rear materials or vice versa.

- When the rear materials (13 to 24) have been selected, the [SHIFT] button (user button) lights in amber.
- When the button is pressed again, it goes off, and the front materials (1 to 12) are now selected.

Basic operations

Single SHIFT

Single SHIFT is used to switch the individual material of a PGM/A bus crosspoint button, PST/B bus crosspoint button or AUX bus crosspoint button from a front material to a rear material or vice versa.

Switching between the front material and rear material is done using the crosspoint button in which the SHIFT function is allocated.

The SHIFT function can be allocated to button No.12 or No.1.

■ Allocating the SHIFT function

① Press the  button to light its indicator, and display the XPT menu.

② Use [F1] to display the XPT Setting sub menu.

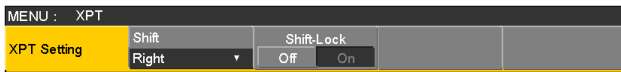

③ Use [F2] to select the button to which the SHIFT function is to be allocated using the Shift item.

Right	Button No.12
Left	Button No.1
Off	Function is not allocated.

④ Use [F3] to select the operation to be performed when the [SHIFT] button is pressed using the Shift-Lock item.

Off	The rear material is selected only while the [SHIFT] button is pressed.
On	The front material and rear material are switched each time the [SHIFT] button is pressed.

- To use the materials that have been set in the button to which the SHIFT function is allocated, either set the SHIFT function Off or allocate the SHIFT function to another button.
- If the [SHIFT] button for “Single SHIFT” is pressed when the rear materials (13 to 24) have been selected using “All SHIFT”, the bus crosspoint buttons concerned will be switched to the front materials.
- When the crosspoint buttons are held down, the button numbers and the names of the input materials assigned to the buttons are displayed on the built-in display in the form of a list for as long as the crosspoint buttons remain held down.

Selecting the bus mode

Select the A/B bus system or flip-flop system (PGM/PST system) from the setting menu.

① Press the  button to light its indicator, and display the Config menu.

② Use [F1] to display the Operate sub menu.

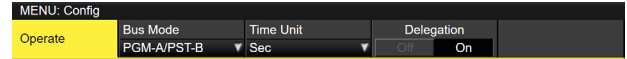

③ Use [F2], and select the A/B or PGM/PST (flip-flop system) using the Bus Mode item.

A/B	When the fader lever is at side A, the signals selected by the A bus are replaced PGM bus materials. When the fader lever is at side B, the signals selected by the B bus are replaced PGM bus materials.
PGM-A/ PST-B	Using a flip-flop system, the signals selected by the A bus are always replaced PGM bus materials, and the signals selected by the B bus are always replaced PST bus materials.
PGM-B/ PST-A	Using a flip-flop system, the signals selected by the B bus are always replaced PGM bus materials, and the signals selected by the A bus are always replaced PST bus materials.

Selecting the transition mode

Select the transition mode using the [MIX] and [WIPE] buttons.

① Press the [BKGD] button in the transition area so that its indicator lights in amber.

When the [BKGD] button and [KEY] button are pressed at the same time, both buttons are selected.

② Use the [MIX] and [WIPE] buttons in the transition area to select the background transition mode.

The indicator of the selected button lights in amber.

Basic operations

Manual transition

Operate the fader lever to execute transitions manually. If the fader lever has been operated during auto transition, auto transition will be switched to manual operation as soon as the fader position overtakes the amount of the transition being executed.

The bus tally LEDs on the left of the fader lever indicate the program bus output status.

Top LED only lights	PGM/A bus output
Top and bottom LEDs light	During the transition
Bottom LED only lights	PST/B bus output

Cut transition

When the [CUT] button is pressed, the transition is executed instantly.

Auto transition

- When the [AUTO] button is pressed, the transition is executed automatically using the transition time which has been set.
- The transition is executed in the remaining time when the [AUTO] button is pressed while the fader lever is being operated.
- The auto transition time is set using the Time menu.

① Press the  button to light its indicator, and display the Time menu.

② Use [F1] to display the BKGD sub menu.



③ Use [F2] to set the transition time in frames.

The display unit is set by selecting Config menu → Operate sub menu → Time Unit item.

Sec	The time is displayed as a number of seconds.
Frame	The time is displayed as a number of frames.

Any time from 0 to 999f can be set. The time which can be set when seconds are used as the display unit differs depending on the system format.

59.94i:	max. 33s09f	59.94p:	max. 16s39f
50i:	max. 39s24f	50p:	max. 19s49f
29.97PsF:	max. 33s09f	29.97p:	max. 33s09f
25PsF:	max. 39s24f	25p:	max. 39s24f
24PsF:	max. 41s15f	24p:	max. 41s15f
23.98PsF:	max. 41s15f	23.98p:	max. 41s15f

Basic operations

Wipe

Selecting the wipe pattern

The wipe patterns are selected using the number keys.

- ① Press the [BKGD PATT] button (or [KEY PATT] button). The [BKGD PATT] button (or [KEY PATT] button) indicator lights in amber, and the pattern table screen appears on the built-in display.
- ② Use [F1] to select the page.
- ③ Use one of the number keys to select the pattern.
- ④ Use [F5] to close the table screen.
 - The table screen can also be closed by pressing the [BKGD PATT] button or [KEY PATT] button and turning off the button's indicator.

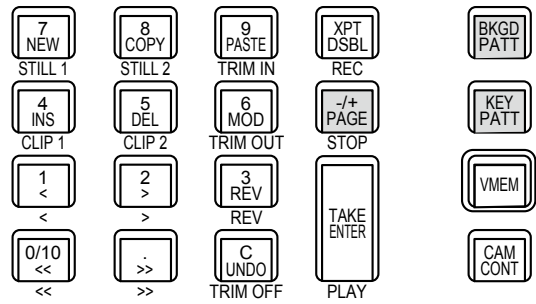

— MEMORY / WIPE PATTERN / 10 KEY

Table of wipe patterns

WIPE 1			WIPE 2			SQ 1			SQ 2		
7	8	9	7	8	9	7	8	9	7	8	9
4	5	6	4	5	6	4	5	6	4	5	6
1	2	3	1	2	3	1	2	3	1	2	3
10			10			10			10		
SL			3D 1			3D 2					
7	8	9	7	8	9	7	8	9			
4	5	6	4	5	6	4	5	6			
1	2	3	1	2	3	1	2	3			
10			10			10					

- The “SQ2: 8” pattern takes effect when the [KEY PATT] button has been pressed.
- When in 4K mode, only WIPE 1 and WIPE 2 are available. The other patterns are available with the optional 4K DVE unit (AV-UHS5M5).

Basic operations

Selecting the wipe direction

Operate the wipe direction selector buttons to select the wipe direction for the background transition.

(The key transitions are set by the menu. The direction which is set here will not be reflected.)

☞ See “Key transitions”.

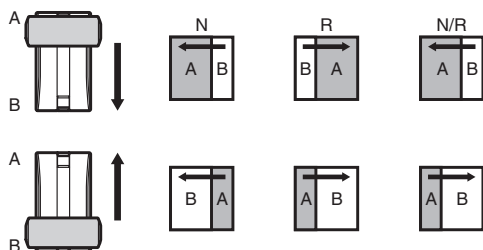

When the [R] indicator is off:

Wiping proceeds in the normal direction.

When the [R] indicator is lit:

Wiping proceeds in the reverse direction.

When the [N/R] indicator is lit:

The normal direction is replaced with the reverse direction (or vice versa) when the transition is completed.

(The lit and extinguished statuses of the [R] button are also switched in line with the direction of the wiping.)

Wipe decorations (border, soft effect)

A border effect or soft effect can be added to the wiping of background transitions.

Setting the border and soft effect

① Press the  button to light its indicator, and display the Background menu.

② Use [F1] to display the Border sub menu.



③ Use [F2] to set On (or Off) for the border using the Border item.

④ Use [F3] to set the width of the border using the Width item.

⑤ Use [F4] to set the amount of soft effect using the Soft item.

When “On” has been selected as the Border item setting, the ratio of the soft effect to the border width is indicated as the amount of soft effect.

When only the soft effect is to be added to wipe, select “Off” as the Border item setting.

Setting the border color

① On the Background menu, use [F1] to display the Border Color sub menu.

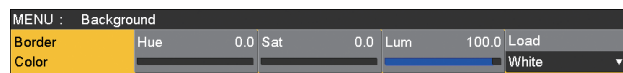

② Use [F2], [F3] and [F4] to adjust the Hue, Sat and Lum of the border color.

■ To call the preset color

Use [F5] to select the preset color using the Load item, and press the [F5].

- When [F5] is pressed, what has been set so far is canceled and replaced with the preset color values.
- To save the values that were set before calling the preset color, refer to “Memory”.

Basic operations

Setting the wipe start position

Wipe start can be set at any desired position.

Target patterns:

WIPE1: 5
 WIPE2: 4, 5, 6, 7
 SQ1: 5
 SQ2: 4, 5, 6, 7

The WIPE pattern is set using the Position sub menu of the Background menu (or Key menu).

- Press the button (or button) to light its indicator, and display the Background menu (or Key menu).
- Use [F1] to display the Position sub menu.



- Either operate the positioners or use [F2] and [F3] to set the wipe start position using the X-Pos item and Y-Pos item.
 This setting is possible only if the target pattern has been selected for the background or key pattern.
- Either operate the fader lever or press the [AUTO] button to check the wipe operation.
 (When, for instance, -50 has been set for X-Pos and -50 for Y-Pos, the following screen (or key) appears from the bottom left and wipe is performed while the screen (or key) moves to the screen center.)

<X-Pos, Y-Pos setting range>

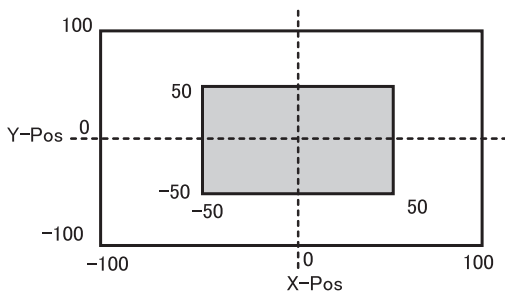

Inside screen area
 Outside screen area

- To copy the start position setting, press [F5] (Copy To Key1 or Copy To BKGD).
 The background setting is copied to the key setting while the key setting is copied to the background setting.

Modifying wipe

Setting the 3D (page turning) effect

A lighting effect can be added to a wipe pattern. Alternatively, the page turning effect parameter can be set. These effects can be set for background transitions and key transitions.

Target patterns:

3D1: 1, 3, 7, 9

- Press the button (or button) to light its indicator, and display the Background menu (or Key menu).
- Use [F1] to display the 3D Modify sub menu.

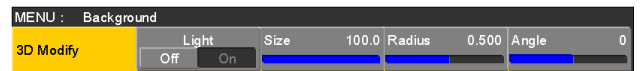

- Use [F2] to select whether the lighting effect is to be added using the Light item.

On	The lighting effect is added.
Off	The lighting effect is not added.



- Use [F3] to set the size when images have been reduced using the Size item.
- Use [F4] to set the radius of the page turning effect using the Radius item.
- Use [F5] to set the direction of the page turning effect using the Angle item.

Basic operations

Setting the trimming

The trimming at the time a background transition is executed can be set.

Target patterns:
SQ1, SQ2, SL, 3D1, 3D2

- Press the  button (or  button) to light its indicator, and display the Background menu (or Key menu).
- Use [F1] to display the Modify sub menu.



- Use [F2] to set the trimming operation and transition operation using the Trim item.

Off	No trimming
16:9	For trimming the edges around the material. This setting is used when a black border, for instance, can be seen around the material.
4:3	For trimming using the 4:3 aspect ratio and releasing the trimming when the transition is completed.
4:3 Smooth	For trimming using the 4:3 aspect ratio and executing the transition to 16:9 images smoothly.

Setting the latency

A delay amount can be set for the background image or key image.

- Press the  button to light its indicator, and display the Config menu.
- Use [F1] to display the Latency sub menu.

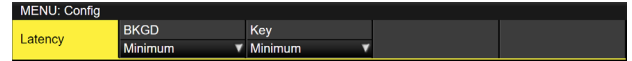

- Use [F2] to set the delay amount for the background image using the BKGD item. Alternatively, use [F3] to set the delay amount for the key image using the Key item. However, only Minimum is available when in the 4K mode.

1F Fix	The image is delayed by one frame (1F). <ul style="list-style-type: none"> There will be no original image remaining when wipe is completed (when SQ1, SQ2, SL, 3D1 or 3D2 has been selected as the wipe pattern).
Minimum	The image is not delayed. <ul style="list-style-type: none"> However, the image will be delayed by one frame (1F) when SQ1, SQ2, SL, 3D1 or 3D2 has been selected as the wipe pattern or when the flying key has been selected.

■ BKGD items

Delay amount setting	At times other than during transitions	MIX/WIPE	SQ/SL/3D
Minimum	No delay	No delay	1F delay
1F Fix	1F delay	1F delay	1F delay

■ Key items

Delay amount setting	At times other than during transitions	MIX/WIPE	SQ/SL/3D/ Flying key
Minimum	No delay	No delay	1F delay
1F Fix	1F delay	1F delay	1F delay

Basic operations

Creating an animated wipe

You can create an animated wipe by linking a video (CLIP) registered in the video memory and an ME transition.

- ① Press the  button to light its indicator, and display the Background menu.
- ② Use [F1] to display the Transition Time sub menu.

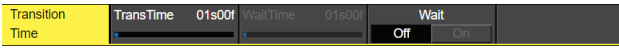

- ③ Use [F2] to set the BKGD transition time in the Trans Time item.
- ④ Use [F3] to set the time to wait before starting the BKGD transition time in the WaitTime item. Press [F4] to enable/disable the WaitTime. The WaitTime is disabled if the settings is Off, irrespective of the WaitTime setting.

- ⑤ Use [F1] to display the Transition Margin sub menu.



- ⑥ Press [F2] to enable/disable the function for adjusting BKGD AUTO transition start/end margin in the Margin item.
- ⑦ Use [F3] to adjust the BKGD AUTO transition start margin in the Start item. The End setting is automatically adjusted if the total when added with the End setting exceeds 10.0.
- ⑧ Use [F4] to adjust the BKGD AUTO transition end point margin in the End item. The Start setting is automatically adjusted if the total when added with the Start setting exceeds 10.0.

- ⑨ Use [F1] to display the Clip Trans Sync sub menu.



- ⑩ Use [F2] to set the Clip1 trigger in the Clip1 item. Triggers can be assigned to the following buttons: AUTO, KEY1 ON, KEY2 ON, KEY3 ON, DSK1 ON, DSK2 ON, FTB ON, Fader. Also use [F3] to set the Clip2 trigger in the Clip2 item. However, only Clip1 is displayed when in the 4K mode.

Key

This operation combines the background image with another image. The key definition can be adjusted, and an edge can be added to the combined image.

Key1, Key2, Key3, DSK1 (downstream key), and DSK2 are available as materials for priority to compose the background images. The default settings for priority (image positioning) are as shown in the figure below.

<Priority default settings>

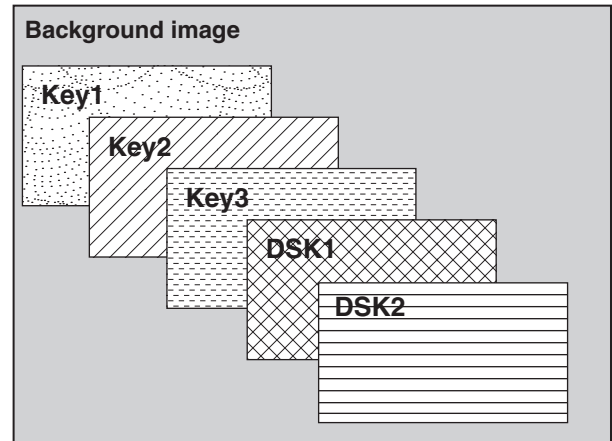

You can change the prioritization for Key1, Key2, and Key3, and the prioritization for DSK1 and DSK2.

Refer to "Setting the priority".

How key combinations work is shown in the figure below.

<How key composition works>

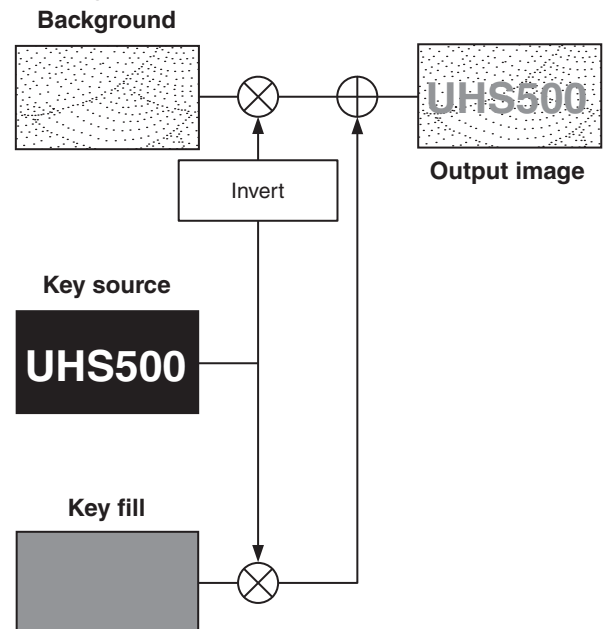

Basic operations

Selecting the key type

- Press the  button to light its indicator, and display the Key menu.
- Use [F1] to display the Key sub menu.

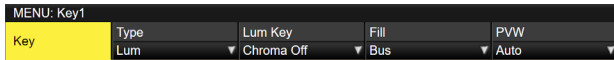

- Use [F2] to select the Type item.

Lum (luminance key/ self key)	This is for creating the key signals from the luminance component or luminance and chroma component of the key fill signal.
Linear (linear key/ EXT key)	This is for creating the key signals from the luminance component of the key source signal. It is used when the key source signal and key fill signal are different.
Chroma (chroma key/ self key)	This is for creating the key signals using a specific hue of the key fill signal as the reference.
Full (full key/self key)	This is for creating the key signals using the images on the full screen as the key source signals. PinP combinations are possible in conjunction with the flying key.  See "Flying key".

Since the luminance and chroma keys are operated as self keys, the key fill signals are used as the key source signals. For the full key, the images on the full screen are used as the key source signals.
When the luminance key, chroma key or full key has been selected as the key type, the key signals will remain unchanged even when the key source signals are switched.

When using the linear key, use material with a black background and white characters or shape to be combined by the key as the key source signal. Material which is not black and white may not be combined clearly.
Material with a white background and black characters, etc. can be reversed using the key invert function for use.

- When the luminance key has been selected, the chroma component can be included in the generation of the key signals in view of the self key application. (This does not apply to the linear key.)
Use [F3], and select the setting using the Lum Key item.

Chroma On	In addition to the luminance component, the chroma component is also taken into account in the generation of the key signals. This is the setting for using a color with a low luminance component for the key signals (such as when defining blue characters).
Chroma Off	The key signals are generated from only the luminance component.

- Use [F4] to select the fill type using the Fill item.

Bus	The bus signal is used for the key fill signal.
Matte	The internal fill matte is used for the key fill signal.

Basic operations

Selecting the key material

Selecting the key fill and key source signals

Press the [KEY] button in the AUX bus selection area, and switch the selection of the key fill signal (indicator lights in amber) and key source signal (indicator lights in green).

<Selecting the key fill signal>

With the indicator of the [KEY] button lit in amber, press one of the AUX bus crosspoint buttons 1 to 12 to select the key fill signal.

The indicator of the selected AUX bus crosspoint button lights in amber. (It will light in red if the selected signal is being output from the PGM connector.)

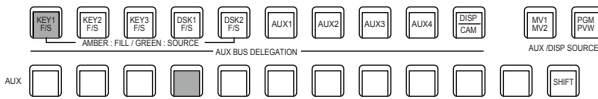

■ Lighting in amber

<Selecting the key source signal>

With the indicator of the [KEY] button lit in green, press one of the AUX bus crosspoint buttons 1 to 12 to select the key source signal.

The indicator of the selected AUX bus crosspoint button lights in green. (It will light in red if the selected signal is being output from the PGM connector.)

Since the luminance and chroma keys are operated as self keys, the key fill signals are used as the key source signals. When the luminance key or chroma key has been selected as the key type, the key signals will remain unchanged even when the key source signals are switched.

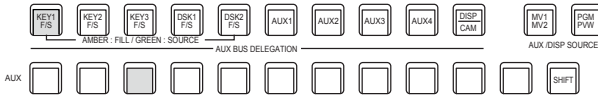

■ Lighting in green

Linking the key fill signal and key source signal selection

- Press the KEY button to be used to display the menu. (KEY1/KEY2/KEY3)
- Use [F1] to display the Key Signal Coupling sub menu and set Independent.

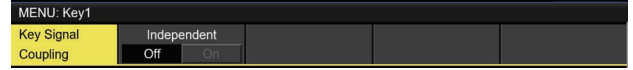

- Press the button to light its indicator, and display the Config menu.

- Use [F1] to display the Key Signal Coupling1 sub menu and set Fill/Source.



- Use [F1] to display the Key Signal Coupling2 to 8 sub menu.

- If Key Signal Coupling1 is Fill to Source, select what to use as the Source for the Fill.
- Alternatively, if it is Source to Fill, select what to use as the Fill for the selected Source.

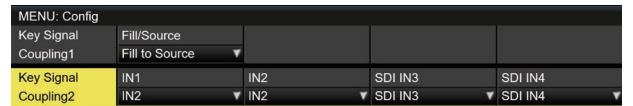

<Independent>

When the [KEY] button lights in amber, the key fill signal can be selected, and when it lights in green, the key source signal can be selected.

Independent

ON	If Fill to Source, you can independently set a Source that is linked to Fill and separate from other KEYS. If Source to Fill, you can independently set a Fill that is linked to Source and separate from other KEYS.
OFF	Settings accord with Key Signal Coupling2 to 8.

Basic operations

<Fill To Source>

When the key fill signal is selected, the key source signal also switches automatically. Initially, the key source signal and the key fill signal will be the same signal.

For example, when “SDI1” is selected for the key fill signal, the key source signal also becomes “SDI1”. After that, when the [KEY] button is pressed and lights in green, “SDI2” is selected for the key source signal. At this time, combination data indicating that the key fill signal is “SDI1” and the key source signal is “SDI2” is recorded on the unit.

After the key fill signal and key source signal have been switched to other signals to perform another operation, if the key fill signal is then selected and set to “SDI1”, the saved combination data causes the key source signal to automatically switch to “SDI2”.

If the key source signal is changed while the key fill signal is set to “SDI1”, the combination data is updated to reflect the change, and is recorded on the unit.

<Source To Fill>

When the key source signal is selected, the key fill signal switches automatically. (The [KEY] button first lights amber.)

The initial values for the key source signal and the key fill signal are the same.

Setting the fill matte color

① Press the [KEY] button to light its indicator, and display the Key menu.

② Use [F1] to display the Fill Matte sub menu.



③ Use [F2], [F3] and [F4] to adjust the Hue, Sat and Lum of the fill matte.

■ To call the preset color

Use [F5] to select the preset color using the Load item, and press the [F5].

- When [F5] is pressed, what has been set so far is canceled and replaced with the preset color values.
- To save the values that were set before calling the preset color, refer to “Memory”.

Key transitions

① Select the transition mode. Press the [KEY] button in the transition area to light its indicator.

To execute a background transition and key transition at the same time, press the [BKGD] button and [KEY] button together to turn on both indicators.

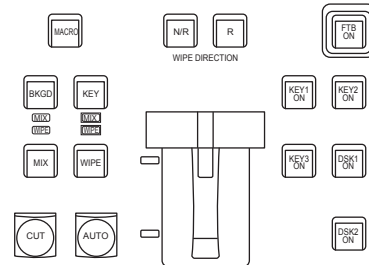

② Select the transition type.

Use the [MIX] button or [WIPE] button in the transition area to select the key transition mode. The selected button lights in amber, and the MIX or WIPE status indicator LED depending on the selected mode lights.

The selected button lights in amber, and the MIX or WIPE status indicator LED depending on the selected mode lights.

If WIPE has been selected, press the [KEY PATT] button in the memory/wipe pattern/number key area to light its indicator, and select the wipe pattern.

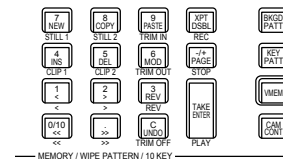

③ Set the time of the transition.

On the Time menu, use [F1] to display the Key sub menu.

As with a background transition, set the transition time.

Basic operations

① Set the wipe direction.

On the Key menu, use [F1] to display the Transition sub menu.

Use [F1] to set “Normal” or “Reverse” using the Keyout Pattern item.

Normal	The key out pattern moves in the same direction as the key in pattern.
Reverse	The key out pattern moves in the opposite direction from the key in pattern.

<Pattern examples>

	Pattern example 1	Pattern example 2	Pattern example 3 ● WIPE1: 5 ● WIPE2: 1 to 7	Pattern example 4 ● SQ1: 5 ● SQ2: 1, 2, 4 to 7 ● 3D1: 5 ● 3D2: 1 to 3
Key in				
Key out (Normal)				
Key out (Reverse)				

: This indicates the areas where keys are combined.

- The operations for pattern example 3 are performed for the “WIPE1: 5” and “WIPE2: 1 to 7” patterns.
- The operations for pattern example 4 are performed for the “SQ1: 5”, “SQ2: 1, 2, 4 to 7”, “3D1: 5” and “3D2: 1 to 3” patterns. The same operations are performed for normal and reverse.

② Execute the transition.

Press the [AUTO] button in the transition area to automatically execute the transition at the transition time that has been set.

Alternatively, execute the transition manually by operating the fader lever.

Key auto transition

When the [KEY ON] button in the transition area is pressed, the transition is automatically executed at the transition time that has been set.

During key in, the indicator of the [KEY ON] button blinks in red, and it lights in red when the transition is completed.

If the [KEY ON] button is pressed with the picture completely keyed in, the Key image transition (key out) is executed.

During key out, the indicator of the [KEY ON] button lights in red, and it goes off when the transition is completed.

If the [KEY ON] button is pressed during the transition, the transition direction is reversed.

Basic operations

Key preview

Key preview images can be output to the preview output, and the keys can be adjusted and checked.

- From the Key menus and the DSK menus, use [F1] to display the Key1/Key2/Key3/DSK1/DSK2 menus.

Key1 menu

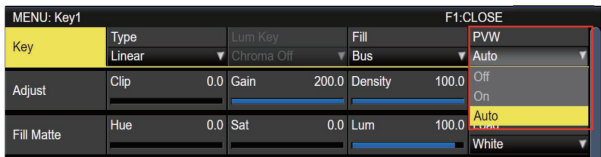

Key2/Key3/DSK1/DSK2 menu

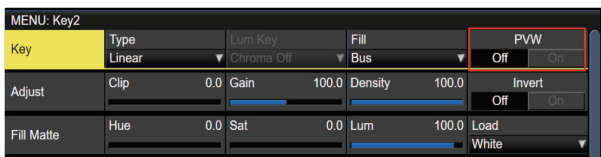

Linking of Menus

The PVW settings of Key2, Key3, DSK1, and DSK2 are linked as shown below.

Key1, which can be set so that it can be operated with AUTO, CUT, and fader when the panel KEY button is ON, can be operated independently because it is different from the other Keys and DSKs.

	PVW	Key1	Key2	Key3	DSK1	DSK2
Key1	On		---	---	---	---
	Off		---	---	---	---
Key2	On	---		Off	Off	Off
	Off	---		---	---	---
Key3	On	---	Off		Off	Off
	Off	---	---		---	---
DSK1	On	---	Off	Off		Off
	Off	---	---	---		---
DSK2	On	---	Off	Off	Off	
	Off	---	---	---	---	

Off: Setting is changed to forced Off.

---: No change

PVW images:

When PVW is OFF:

- The PGM status is displayed in the PVW.
- This is not reflected in the transition status, however.

When PVW is ON:

When PVW is set to "On", the PGM images are displayed after the PVW.

You can set PVW to "On" for only one of Key2, Key3, DSK1, or DSK2.

Key1 is independent, so a maximum of 2 Keyers can be put on the PVW.

When PVW is Auto:

PVW can be set to "Auto" only for Key1.

When you press a KEY button in the transition area, the following two statuses are switched:

- When the KEY button is lit, the operation is with PVW "On".
- When the KEY button is off, the operation is with PVW "Off".

Background of the PVW:

The BKGD image for PVW is modified by the PVW setting and the setting status of the BKGD and KEY buttons in the transition area.

Basically there will be PGM images when either Key PVW or DSK PVW is "On".

However, these will become PST when both the BKGD and KEY buttons in the transition area are "On".

When a user button to which the On/Off settings have been allocated is pressed, the setting is switched alternately between On (button indicator lights) and Off (button indicator extinguished), and the "Auto" setting is not selected.

(The relevant user button items are KEY1_PVW/KEY2_PVW/KEY3_PVW/DSK1_PVW/DSK2_PVW.)

Menu	User button	When the user button is pressed
On	Lights	Off: Extinguished
Off	Extinguished	On: Lights
Auto	Extinguished	On: Lights

When "Auto" is selected using a menu operation, the user button indicator is turned off (extinguished).

Basic operations

Adjusting the luminance key and linear key

These steps are taken to adjust the luminance key and linear key definition.

① Press the  button to light its indicator, and display the Key menu.

② Use [F1] to display the Adjust sub menu.

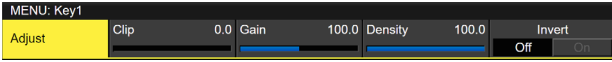

③ Use [F2], [F3] and [F4] to adjust the key definition.

④ Use [F5] to set key invert. When “On” is selected, the key signals to be generated internally are inverted.

Operation/Parameter	Description of setting	Setting range
F2/Clip	Reference level for generating key signals	0.0 to 108.0
F3/Gain	Key amplitude	0.0 to 200.0
F4/Density	Key density	0.0 to 100.0
F5/Invert	Key signal inversion	On, Off

Adjusting the chroma key

Sampling is executed for the selected key materials to adjust those aspects of the key that are to be compensated.

Step 1

■ To execute the sampling automatically

① Press the  button to light its indicator, and display the Chroma Key menu.

② Use [F1] to display the Auto Compute sub menu.



③ Press [F2] to execute the sampling automatically. To undo what has been sampled, press [F5].

■ To execute the sampling manually

This changes the manual adjustment mode to the sample mode.

① Press the  button to light its indicator, and display the Chroma Key menu.

② Use [F1] to display the Adjusting Mode sub menu.



③ Use [F2] to select Sample Mode.

④ Use [F1] to display the Sample sub menu.

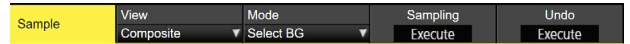

⑤ Use [F2] to select “Composite” (composite image that combines the background image and key) using the View item.

⑥ Use [F3] to select “Select BG” using the Mode item.

Select BG	A color for the background of the foreground image is specified. Normally, either a blue or green background is specified.
------------------	----------------------------------------------------------------------------------------------------------------------------

⑦ Use the positioner to move the position of the sample marker.

To change the size of the sample marker, turn the rotary encoder [Z].

⑧ If the sample area that has been set is acceptable, press the rotary encoder [Z].

The area that has been set is now sampled.

⑨ To return to the pre-sampling status after sampling has been executed, press [F5].

Basic operations

Step 2

The objective of this step is to remove the noise in the background image.
The noise is removed by carrying out this step several times.

- ① On the Chroma Key menu, use [F1] to display the Sample sub menu.

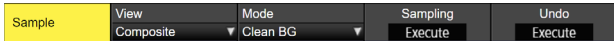

- ② Use [F2] to select "Matte" (Matte image) using the View item.
- ③ Use [F3] to select "Clean BG" using the Mode item.

Clean BG	The noise in the background image is removed.
-----------------	-----------------------------------------------

- ④ Using the positioner, move the position of the sample marker to the position of the noise (white dots) in the background image.
To change the size of the sample marker, turn the rotary encoder [Z].
- ⑤ If the sample area that has been set is acceptable, press the rotary encoder [Z].
The noise in the area that has been set is now removed.
- ⑥ To return to the pre-sampling status after sampling has been executed, press [F5].



Before the noise is removed



After the noise is removed

Step 3

The objective of this step is to remove the noise in the foreground image.
The noise is removed by carrying out this step several times.

- ① Use [F2] to select "Matte" (Matte image) using the View item.

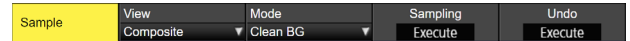

- ② Use [F3] to select "Clean FG" using the Mode item.

Clean FG	The noise in the foreground image is removed.
-----------------	-----------------------------------------------

- ③ Using the positioner, move the position of the sample marker to the position of the noise (black dots) in the foreground image.
To change the size of the sample marker, turn the rotary encoder [Z].
- ④ If the sample area that has been set is acceptable, press the rotary encoder [Z].
The noise in the area that has been set is now removed.
- ⑤ To return to the pre-sampling status after sampling has been executed, press [F5].

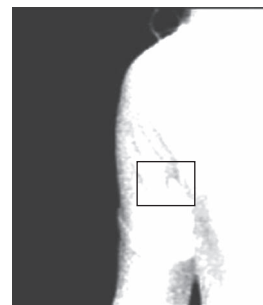

Before the noise is removed

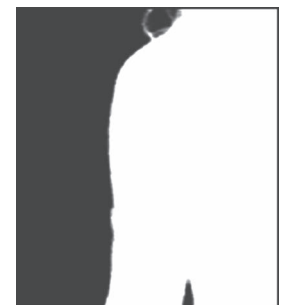

After the noise is removed

Basic operations

Step 4

After steps 1 to 3 have been carried out, noise will still remain in the detail areas such as the subject's hair as shown in the image below.

Noise remaining in the detail areas is also removed in "step 4".

If there are many areas with noise, the noise is removed by carrying out this step several times.



- ① Use [F2] to select "Composite" (composite image that combines the background image and key) using the View item.



- ② Use [F3] to select "Sponge" using the Mode item.

Sponge	The noise remaining in the detailed areas is removed.
---------------	-------------------------------------------------------

- ③ Using the positioner, move the position of the sample marker to the position of the remaining noise. To change the size of the sample marker, turn the rotary encoder [Z].
 - ④ If the sample area that has been set is acceptable, press the rotary encoder [Z]. The noise in the area that has been set is now removed, and the colors become more natural.
 - ⑤ To return to the pre-sampling status after sampling has been executed, press [F5].
- Execute sampling in both the light and dark areas as the sample area.
 - If the noise in the foreground image is not completely removed by carrying out the steps above, proceed with the FineTuning sub menu operation.

Step 5

The objective of this step is to finely adjust the image by adjusting the noise and transparency, for example.

- ① On the Chroma Key menu, use [F1] to display the Sample sub menu.

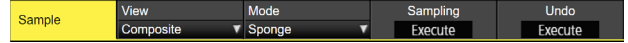

- ② Use [F2] to select the image to be adjusted using the View item.

Composite	Composite image that combines the background image and key
Matte	Matte image
Proc.FG	Process foreground image
FG	Foreground image

- ③ Use [F3] to select the adjustment function using the Mode item. For details on the items, refer to "[FineTuning]".
- ④ Using the positioner, move the position of the sample marker to the position to be sampled. To change the size of the sample marker, turn the rotary encoder [Z].
- ⑤ If the sample area that has been set is acceptable, press the rotary encoder [Z]. The area that has been set is now sampled.
- ⑥ To return to the condition of a step earlier after an adjustment has been made, press [F5].

Basic operations

[FineTuning]

In this mode, detailed images can be adjusted.

- ① On the Chroma Key menu, use [F1] to display the Sample sub menu.

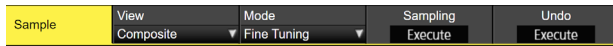

- ② Use [F2] to select "Composite" using the View item.
- ③ Use [F3] to select "FineTuning" using the Mode item.
- ④ Using the positioner, move the position of the sample marker to the position to be sampled.
To change the size of the sample marker, turn the rotary encoder [Z].
- ⑤ If the sample area that has been set is acceptable, press the rotary encoder [Z].
- ⑥ On the Chroma Key menu, use [F1] to display the Fine Tuning sub menu.



- ⑦ Use [F2] to remove or restore the noise using the Spill item.
When it is turned clockwise, a large amount of noise is removed from the foreground image, and the image colors increasingly approach the complementary color (opposite color) of the blue screen.
When it is turned counterclockwise, the image colors approach the colors of the original foreground image.
- ⑧ By turning [F3] clockwise, the matte of the colors closely resembling the colors of the foreground image can be adjusted using the Trans item.
This is useful when, for instance, areas covered with dark smoke or clouds in a foreground image are to be made semi-transparent.
- ⑨ By turning [F4] clockwise, the matte information for the colors closely resembling the colors of the background image can be adjusted using the Detail item.
This is useful when, for instance, restoring the details of an image (such as an image with a subject who has loose hair or an image with smoke), which have been lost in the foreground image as a result of sampling, to what they were in the original image.

Step 6

Finely adjust the chroma key signals which have been generated.

- ① On the Chroma Key menu, use [F1] to display the Adjust sub menu.



- ② Use [F2], and adjust the width of the chroma key signals using the Narrow item.
The key signal width can be adjusted horizontally in 0.5 (half-pixel) increments.
- ③ Use [F3], and adjust the horizontal phase of the chroma key signals using the Phase item.
The key signal position can be moved horizontally in 0.5 (half-pixel) increments.

Basic operations

■ When manually adjusting the 3 border surfaces

This changes the manual adjustment mode to the Value mode.

The Value mode is a mode that enables adjustment of the 3 border surfaces as whole by changing values.

In the chroma key algorithm adopted by this unit, color signals are divided into 4 regions by polyhedra with 128 faces.

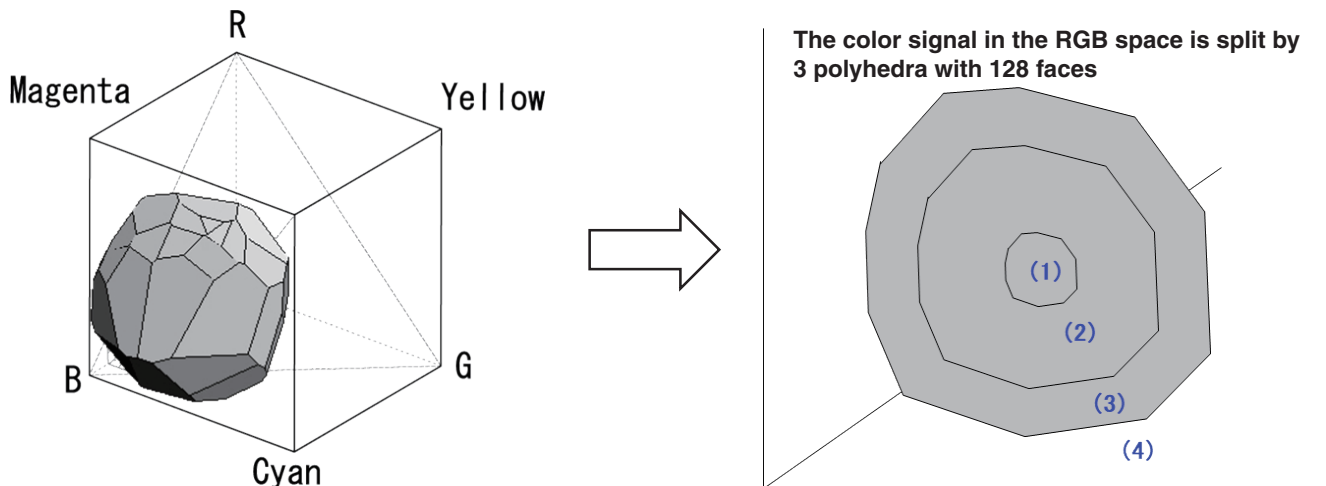

Region (1)	100% background
Region (2)	Transparent or translucent parts such as glass or water
Region (3)	Foreground with Spill removed
Region (4)	100% foreground

The below illustration is an overview of the Value mode.

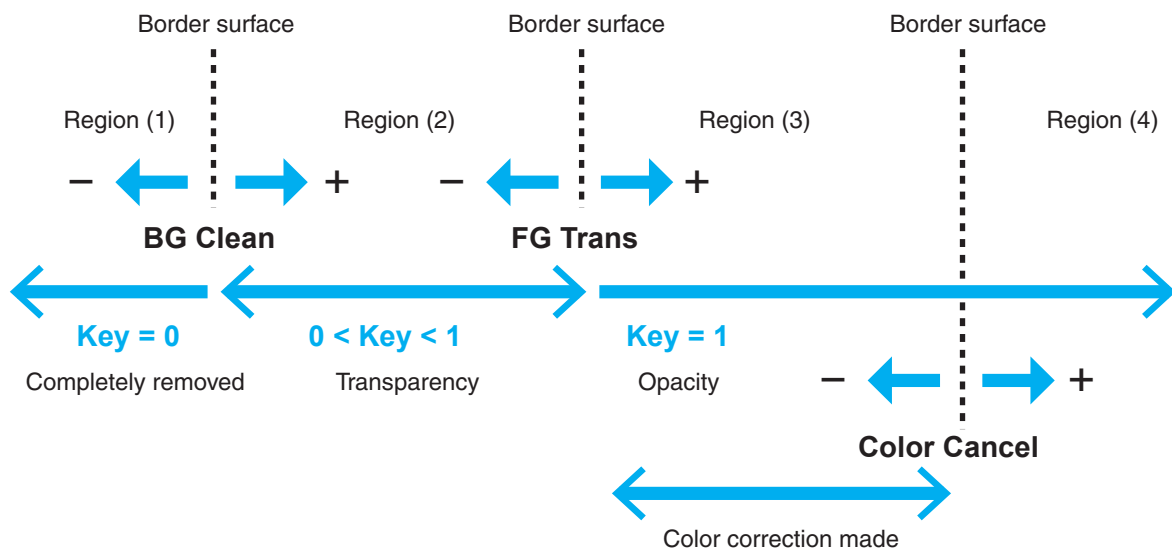

In the Value mode, each border surface can be adjusted with the following 3 parameters.

BG Clean	Border surface between regions (1) and (2)	By adjusting the values to the + side, the noise in the blue background can be reduced.
FG Trans	Border surface between regions (2) and (3)	By adjusting the values to the + side, the subject is made more transparent.
Color Cancel	Border surface between regions (3) and (4)	By adjusting the values to the + side, the color of the subject part is shifted to a deeper skin tone.

Basic operations

① Press the  button to light its indicator, and display the Chroma Key menu.

② Use [F1] to display the Adjusting Mode sub menu.

Adjusting Mode	Adjusting Mode Value Mode				
Value	Sample Mode Value Mode	FG Trans	-10.00	BG Clean	10.00

③ Use [F2] to select Value Mode.

④ Use [F1] to display the Value sub menu.

Value	ColorCancel	0.00	FG Trans	0.00	BG Clean	0.00
-------	-------------	------	----------	------	----------	------

⑤ Use [F2] to adjust the border surfaces between regions (3) and (4) in the Color Cancel item.

By adjusting the values to the + side, the color of the subject part is shifted to a deeper skin tone.

⑥ Use [F3] to adjust the border surfaces between regions (2) and (3) in the FG Trans item.

By adjusting the values to the + side, the subject is made more transparent.

⑦ Use [F4] to adjust the border surfaces between regions (1) and (2) in the BG Clean item.

By adjusting the values to the + side, the noise in the blue background can be reduced.

Basic operations

Key decorations

A border, shadow or other edge can be added to the key.

Setting the key edge

- Press the  button to light its indicator, and display the Key menu.
- Use [F1] to display the Edge1 sub menu.

MENU : Key				
Edge 1	Type	Width	Direction	Density
	Off	2	0	100%

- Use [F2] to select the edge type.

Off	An edge is not added.
Border	A border is added around the entire edge.
Drop	A diagonal border is added.
Shadow	A shadow is added.
Outline	An outline (only a border with no fill) is added.

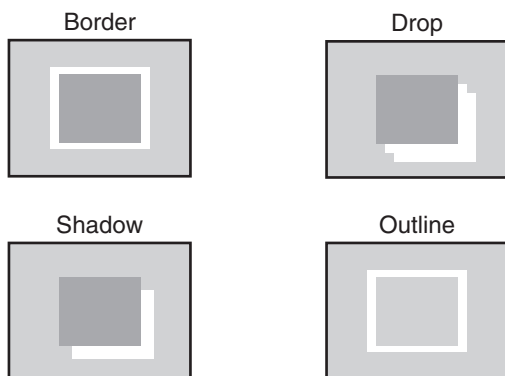

- Use [F3] to set the edge width.
- Use [F4] to set the direction (in 45-degree increments) in which “Drop” and “Shadow” will be added.

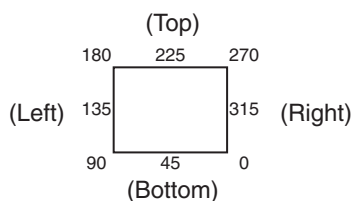

- Use [F5] to set the darkness (Density) of the edges.

Selecting the Edge Fill settings

Materials to be inserted as edges can be set.

- On the Key menu, use [F1] to display the Edge2 sub menu.

MENU : Key			
Edge2	Edge Fill		
	Color		

- Use [F2] to select the edge material using the Edge Fill items.

Color	The color set using Edge Color is used.
CBGD1	The color background is used.
CBGD2	
Still1	The still image video memory (Still1) is used.
Still2	The still image video memory (Still2) is used.
Clip1	The moving image video memory (Clip1) is used.
Clip2	The moving image video memory (Clip2) is used.

- Still2 and Clip2 cannot be selected in 4K mode.

Setting the edge color

- On the Key menu, use [F1] to display the Edge Color sub menu.

MENU : Key					
Edge Color	Hue	Sat	Lum	Load	
	0.0	0.0	100.0	Black	

- Use [F2], [F3] and [F4] to adjust the Hue, Sat and Lum of the edge color.

■ To call the preset color

Use [F5] to select the preset color using the Load item, and press the [F5].

- When [F5] is pressed, what has been set so far is canceled and replaced with the preset color values.
- To save the values that were set before calling the preset color, refer to “Memory”.

Basic operations

Masking the key signals

These steps are taken to mask the key signals using the mask signal of the box pattern.

- Press the  button to light its indicator, and display the Key menu.
- Use [F1] to display the Mask sub menu.



- Use [F2], and select the masking method using the Mask item.

Off	The key signals are not masked.
Manual	The area that is set using the Mask Adjust sub menu is masked.
4:3	The signals are masked to the 4:3 aspect ratio.

- Use [F3] to set whether to invert the mask signal using the Invert item.

On	The mask signal is inverted.
Off	The mask signal is not inverted.

- Use [F1] to display the Mask Adjust sub menu.

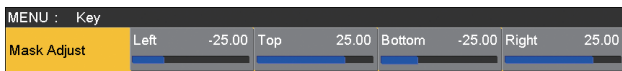

- Use [F2] to [F5] to set the area to be masked.

Operation/Parameter	Description of setting	Setting range/Initial value
F2/Left	Key left position	-50.00 to 50.00/ -25.00
F3/Top	Key top position	-50.00 to 50.00/ 25.00
F4/Bottom	Key bottom position	-50.00 to 50.00/ -25.00
F5/Right	Key right position	-50.00 to 50.00/ 25.00

The Left setting cannot exceed the Right setting (and vice versa) and, similarly, the Top setting cannot exceed the Bottom setting (and vice versa).

<Key mask setting> (figure shows the default values)

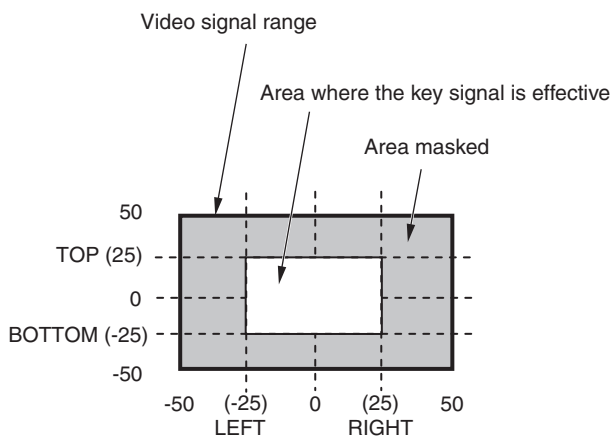

Flying key

Using DVE effects, this key enables the key signals that have been input to be moved, expanded or contracted. In order for the flying key to take effect, select "SQ2: 8" as the key transition.

Refer to "Selecting the wipe pattern".

When the key transition is executed, the keys are combined by the key signals set using the flying key menu. (The transition effect is fixed at MIX.)

Since the flying key uses DVE effects, the image is delayed by one frame.

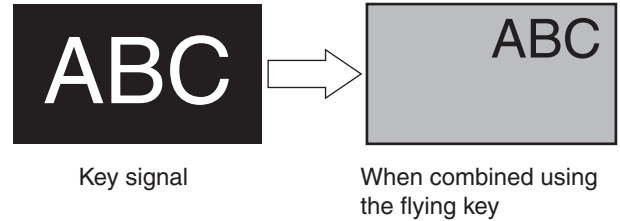

In order to add the edge of the key before the DVE effect, the thickness of the edge is also changed when the size is changed.

Adjusting position and size

- Press the  button to light its indicator, and display the Key menu.
- Use [F1] to display the Flying Key Position/Size sub menu.



- Use [F2] to set the X coordinate of the key signal using the X-Pos item.
- Use [F3] to set the Y coordinate of the key signal using the Y-Pos item.
- Use [F4] to set the key signal change size (max. 400: 400%) using the Size item.

Basic operations

Adjusting rotation

- Press the  button to light its indicator, and display the Key menu.
- Use [F1] to display the Flying Key Rotation sub menu.



- Use [F2] to set the X rotation of the key signal in the X item.
- Use [F3] to set the Y rotation of the key signal in the Y item.
- Use [F4] to set the Z rotation of the key signal in the Z item.

Adjusting aspect ratio

- Press the  button to light its indicator, and display the Key menu.
- Use [F1] to display the Flying Key Aspect sub menu.

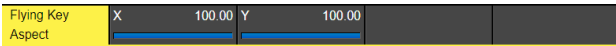

- Use [F2] to set the horizontal ratio of the key signal in the X item.
- Use [F3] to set the vertical ratio of the key signal in the Y item.

PinP combinations using the flying key

When “Full” is selected using the Type item in “Selecting the key type”, PinP combinations can be performed using the flying key. (At this point in time, the Clip item and Gain item cannot be set on the Adjust sub menu.)



With the full key, the image on the full screen serves as the key source signal so an edge will not be added unless a further step is taken.

To add an edge, mask the key signals so that the key source signals are made smaller than the entire screen.

 For details on masking, refer to “Masking the key signals”.

Setting the priority

The relative positions of the images when Key1, Key2 and Key3 images are to be superimposed onto one another can be set.

- Press the  button (or  button) to light its indicator, and display the Key menu.
- Use [F1] to display the Key Priority sub menu.



- Use [F2] to [F4] to set the relative positions using the 3rd item, 2nd item and 1st item.

1st	This is used to set the image to be placed at the top.
2nd	This is used to set the image to be placed in the middle.
3rd	This is used to set the image to be placed at the bottom.

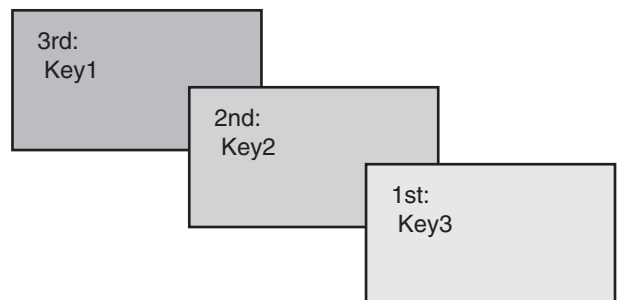

Basic operations

PinP (picture in picture)

Another image can be combined with the background image. This unit supports PinP for 2 channels, DSK and Key.

Selecting the PinP channel and material

In 2K mode or HD mode:

Press the [Key2] button among the AUX bus selector buttons.

In 4K mode or when there is no 4K DVE unit:

Press the [Key1] button among the AUX bus selector buttons.

When the [Key2] button (or [Key1] button) is lit, the PinP menu is displayed on the built-in display.

The state in which the PinP materials are selected is now established for the AUX bus crosspoint buttons.

The selected AUX bus crosspoint button lights in amber. (It will light in red if the selected signal is a PGM output signal.)

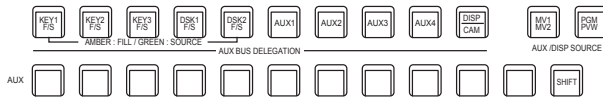

Selecting Shape

Square, Circle, Heart, Flower or Star can be selected as the shape used for combining PinP images.

- ① Press the [Key2] button (2K/HD mode) or [Key1] button (in 4K mode or when there is no 4K DVE unit) to light the button and display the PinP menu.
- ② Use [F1] to display the PinP sub menu.
- ③ Use [F4] and, using the Shape item, select the shape used for combining images.
- ④ Use [F5] to adjust the transmissivity (darkness) applying when the images are combined using the Density item.



Full Key On/Off

- ① In the PinP sub menu, use [F3] to enable (On)/disable (Off) Full Key.

On	Irrespective of the values set with the Key sub menu, PinP images are composed with Full Key.
Off	PinP images are composed according to the values set with the Key sub menu.

Basic operations

PinP adjustments

Adjusting the PinP position and size

While the PinP menu is selected, adjust the X and Y coordinates using the positioner in the positioner area, and adjust the size using the rotary encoder [Z]. Alternatively, the settings can be performed on the menus.

- ① Press the [Key2] button (2K/HD mode) or [Key1] button (in 4K mode or when there is no 4K DVE unit) to light the button and display the PinP menu.

- ② Use [F1] to display the PinP Position sub menu.



- ③ Either operate the positioner and the rotary encoder [Z] or use [F2], [F3] and [F4] to set the X and Y coordinates and the size using the X-Pos, Y-Pos and Size items.

Linking Key PinP and DSK PinP

The Key PinP and DSK PinP images perform a symmetrical operation for the axis whose coordinates and rotation angle have been set.

The image serving as the reference is the PinP image of the menu being operated.

Linking Key PinP and DSK PinP

- ① Press the [Key2] button (2K/HD mode) or [Key1] button (in 4K mode or when there is no 4K DVE unit) to light the button and display the PinP menu.

- ② Use [F1] to display the PinP Sync sub menu.



- ③ Use [F2] to select the position that will serve as the reference using the Sync item. The image serving as the reference is the PinP image of the menu being operated.

When "X" has been selected as the Symmetry setting

The coordinates and rotation angle are made symmetrical to the X axis.

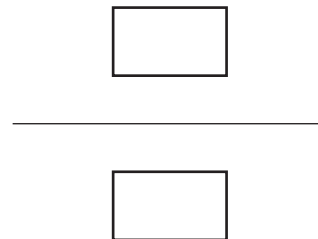

When "Y" has been selected as the Symmetry setting

The coordinates and rotation angle are made symmetrical to the Y axis.

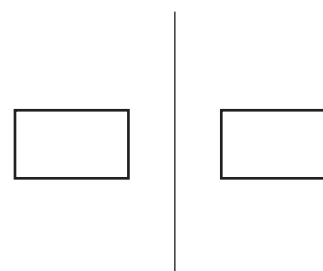

Basic operations

When "Center" has been selected as the Symmetry setting

The coordinates and rotation angle are made symmetrical to the center.

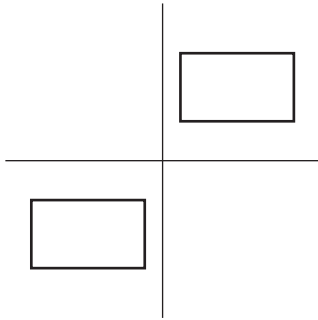

When "Same" has been selected as the Symmetry setting

The coordinates are the same.



Copying the settings

The Key PinP settings can be copied to DSK PinP and, similarly, the DSK PinP settings can be copied to Key PinP.

- On the PinP menu, use [F1] to display the PinP Sync sub menu.



- Use [F2] to select "Off" using the Sync item.
- When [F5] is pressed, the Key PinP (or DSK PinP) settings are copied and set in DSK PinP (or Key PinP).

Note

The following settings are not copied.

- PinP Trim sub menu items
- PinP sub menu items

PinP decorations

A border or soft effect can be added to PinP.

- Press the [Key2] button (2K/HD mode) or [Key1] button (in 4K mode or when there is no 4K DVE unit) to light the button and display the PinP menu.

- Use [F1] to display the PinP Border sub menu.



- Use [F2] to set On (or Off) for the border using the Border item.
- Use [F3] to set the width of the border using the Width item.
- Use [F4] to set the amount of soft effect using the Soft item. The soft effect is OFF if 0.0 is set. When "On" has been selected as the Border item setting, the ratio of the soft effect to the border width is indicated as the amount of soft effect. When only the soft effect is to be added to PinP, select "Off" as the Border item setting.
- Use [F5] to set the change in the border width using the Mode item.

Fix	The border width is kept constant.
Variable	The border width changes to suit the PinP size.

Setting the border color

- On the PinP menu, use [F1] to display the PinP Border Color sub menu.



- Use [F2], [F3] and [F4] to adjust the Hue, Sat and Lum of the border color.

To call the preset color

Use [F5] to select the preset color using the Load item, and press the [F5].

- When [F5] is pressed, what has been set so far is canceled and replaced with the preset color values.
- To save the values that were set before calling the preset color, refer to "Memory".

Basic operations

Trimming settings

① Press the [Key2] button (2K/HD mode) or [Key1] button (in 4K mode or when there is no 4K DVE unit) to light the button and display the PinP menu.

② Use [F1] to display the Trim sub menu.



③ Use [F2] to set the trimming On/Off in the Trim item.

On	Trimming is performed.
Off	No trimming

④ Use [F3] to select the trimming type.

16:9	Automatic trimming so that the aspect ratio is 16:9.
12:9	Automatic trimming so that the aspect ratio is 12:9.
9:9	Automatic trimming so that the aspect ratio is 9:9.
7:9	Automatic trimming so that the aspect ratio is 7:9.
6:9	Automatic trimming so that the aspect ratio is 6:9.
Manual	Trimming using the value set on the Trim sub menu.

⑤ Use [F3] to set the Pair On/Off in the Pair item.

On	The settings are changed in such a way that the Left and Right trimming amounts and the Top and Bottom trimming amounts are the same. (This makes for a top-bottom and left-right symmetry.)
Off	Pair settings not made.

⑥ Use [F1] to display the PinP Trim Adjust sub menu, and use [F2], [F3], [F4] and [F5] to set the trimming values.

Operation/Parameter	Description of setting	Setting range/Initial value
F2/Left	Trimming value at left	-50.00 to 50.00/ -50.00
F3/Top	Trimming value at top	-50.00 to 50.00/ 50.00
F4/Bottom	Trimming value at bottom	-50.00 to 50.00/ -50.00
F5/Right	Trimming value at right	-50.00 to 50.00/ 50.00

<Trimming settings> (figure shows the default values)

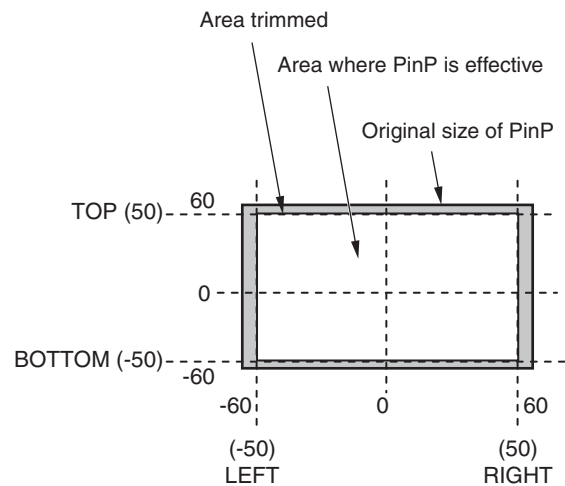

Basic operations

DSK (downstream key)

Characters or other images can be combined with the background image.

There are 2 types of DSK; DSK1 and DSK2.

Selecting the DSK type

① Press the  button to light its indicator, and display the DSK menu.

② Use [F1] to display the DSK sub menu.

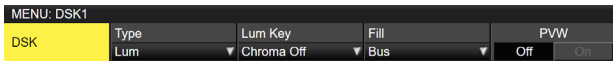

③ Use [F2] to select the Type item.

DSK1:

There are 4 options; Lum, Linear, Chroma, and Full.

DSK2:

There are 3 options; Lum, Linear, and Full.

Lum (luminance key/ self key)	This is for creating the key signals from the luminance component of the key fill signal.
Linear (linear key/ EXT key)	This is for creating the key signals from the luminance component of the key source signal. It is used when the key source signal and key fill signal are different.
Chroma (chroma key/ self key)	This is for creating the key signals based on a particular hue of the key fill signal.
Full (full key/ self key)	This is for creating the key signals using the images on the full screen as the key source signal.

Since the luminance key is operated as a self key, the key fill signals are used as the key source signals. When the luminance key has been selected as the downstream key type, the key signals will remain unchanged even when the key source signals are switched.

When using the linear key, use material with a black background and white characters or shape to be combined by the key as the key source signal. Material which is not black and white may not be combined clearly.
Material with a white background and black characters, etc. can be reversed using the key invert function for use.

④ When the luminance key has been selected, the chroma components can be contained in the key signals generated in view of the fact that it is used as a self key. (This is not applied to the linear key.)

Use [F3] to select the setting using the Lum Key item.

Chroma On	In addition to the luminance components, the chroma components are also factored in when generating the key signals. Use this setting if colors with low luminance components are used for the key signals (when, for instance, blue characters are to be removed).
Chroma Off	The key signals are generated only from the luminance components.

⑤ Use [F4] to select the fill type using the Fill item.

Bus	The bus signal is used for the key fill signal.
Matte	The internal fill matte is used for the key fill signal.

Setting the fill matte color

① On the DSK menu, use [F1] to display the Fill Matte sub menu.



② Use [F2], [F3] and [F4] to adjust the Hue, Sat and Lum of the fill matte.

■ To call the preset color

Use [F5] to select the preset color using the Load item, and press the [F5].

- When [F5] is pressed, what has been set so far is canceled and replaced with the preset color values.
- To save the values that were set before calling the preset color, refer to "Memory".

Basic operations

Selecting the DSK material

Selecting the DSK fill signal and DSK source signal

Press the [DSK] button in the AUX bus selection area to switch the selection of the DSK fill signal (indicator lights in amber) and DSK source signal (indicator lights in green).

<Selecting the DSK fill signal>

While the indicator of the [DSK] button is lit in amber, press one of the AUX bus crosspoint buttons 1 to 12 to select the DSK fill signal.

The indicator of the selected AUX bus crosspoint button lights in amber. (It lights in red if the selected signal is being output from the PGM connector.)

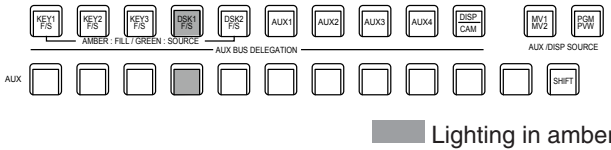

<Selecting the DSK source signal>

While the indicator of the [DSK] button is lit in green, press one of the AUX bus crosspoint buttons 1 to 12 to select the DSK source signal.

The indicator of the selected AUX bus crosspoint button lights in green. (It lights in red if the selected signal is being output from the PGM connector.)

Since the luminance key is operated as a self key, the key fill signals are used as the key source signals. When the luminance key has been selected as the downstream key type, the key signals will remain unchanged even when the key source signals are switched.

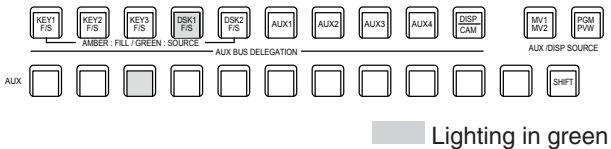

Linking the DSK fill signal and DSK source signal selection

- Press the button to light it, and display the Config menu.
- Use [F1] to display the Key Signal Coupling1 sub menu.



- Use [F2] to select the linking method for the DSK fill signal and DSK source signal by using the Fill/Source item.

Fill To Source	When the DSK fill signal is selected, the DSK source signal changes automatically.
Source To Fill	When the DSK source signal is selected, the DSK fill signal changes automatically.

<Fill To Source>

When the DSK fill signal is selected, the DSK source signal also switches automatically.

Initially, the DSK source signal and the DSK fill signal will be the same signal.

For example, when “SDI1” is selected for the DSK fill signal, the DSK source signal also becomes “SDI1”. After that, when the [DSK] button is pressed and lights in green, “SDI2” is selected for the DSK source signal. At this time, combination data indicating that the DSK fill signal is “SDI1” and the DSK source signal is “SDI2” is recorded on the unit.

After the DSK fill signal and DSK source signal have been switched to other signals to perform another operation, if the DSK fill signal is then selected and set to “SDI1”, the saved combination data causes the DSK source signal to automatically switch to “SDI2”.

If the DSK source signal is changed while the DSK fill signal is set to “SDI1”, the combination data is updated to reflect the change, and is recorded on the unit.

<Source To Fill>

When the DSK source signal is selected, the DSK fill signal switches automatically.

However, be aware that if the [DSK] button is pressed when it is not lit, the [DSK] button will first light green, and the mode will be that for selecting the DSK source signal.

Basic operations

The recorded combination information can be set from combinations of Coupling1 to 8 in the Key Signal Coupling sub menu.

Key Signal Coupling1	Fill/Source Fill to Source ▼			
Key Signal Coupling2	IN1 IN1 ▼	IN2 IN2 ▼	SDI IN3 SDI IN3 ▼	SDI IN4 SDI IN4 ▼
Key Signal Coupling3	SDI IN5 SDI IN5 ▼	SDI IN6 SDI IN6 ▼	SDI IN7 SDI IN7 ▼	SDI IN8 SDI IN8 ▼
Key Signal Coupling4	IN-A1 IN-A1 ▼	IN-A2 IN-A2 ▼	IN-A3 IN-A3 ▼	IN-A4 IN-A4 ▼
Key Signal Coupling5	IN-B1 IN-B1 ▼	IN-B2 IN-B2 ▼	IN-B3 IN-B3 ▼	IN-B4 IN-B4 ▼
Key Signal Coupling6	Black Black ▼	CBAR CBAR ▼	CBGD 1 CBGD 1 ▼	CBGD 2 CBGD 2 ▼
Key Signal Coupling7	Still 1V Still 1V ▼	Still 1K Still 1K ▼		
Key Signal Coupling8	Clip 1V Clip 1V ▼	Clip 1K Clip 1K ▼		

The initial values for the DSK source signal and the DSK fill signal are the same.

Independently set the selection for the DSK fill signal and the DSK source signal

- From the DSK menu, use [F1] to display the DSK Signal Coupling sub menu.



DSK Signal Coupling	Independent Off On			
---------------------	-----------------------	--	--	--

- Use [F2] to set On/Off in the Independent item.

<Independent>

When the [DSK] button lights in amber, the DSK fill signal can be selected, and when it lights in green, the DSK source signal can be selected.

DSK transitions

- Set the transition time.
Press the  button to light its indicator, and display the Time menu.
- Use [F1] to display the DSK sub menu.
As with background transitions, set the transition time.
 Refer to “Auto transition”.
- When the [DSK1 ON] or [DSK2 ON] button in the transition area is pressed, the DSK image is combined (fades in) for the length of the transition time that has been set.

During fade-in, the [DSK1 ON] or [DSK2 ON] button blinks in red, and when the transition (fades in) is completed, it lights in red.

When the [DSK1 ON] or [DSK2 ON] button is pressed after fade-in is completed, the DSK image transitions (fades out).

During fade-out, the [DSK1 ON] or [DSK2 ON] button lights in red, and when the transition (fades out) is completed, it goes off.

If the [DSK1 ON] or [DSK2 ON] button is pressed at any point during a transition, the direction of the transition is reversed.

Basic operations

DSK preview

Select whether to output the DSK preview image to the preview output.

- ① Press the  button to light its indicator, and display the DSK menu.
- ② Use [F1] to display the DSK sub menu.



- ③ Use [F5] to set the PVW item.

On	An image with the DSK effect added is output to the preview output.
Off	An image without the DSK effect added is output to the preview output.

The PVW On and Off settings can be allocated to the user buttons.

☞ Refer to “Setting the user buttons”.

DSK adjustments

The DSK definition can be adjusted.

- ① Press the  button to light its indicator, and display the DSK menu.
- ② Use [F1] to display the Adjust sub menu.

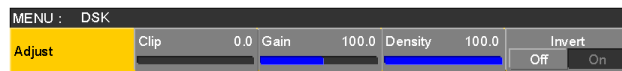

- ③ Use [F2], [F3] and [F4] to adjust the DSK (downstream key) definition.
- ④ Use [F5] to set key invert.
If “On” is set, the key signals generated internally are inverted.

Operation/Parameter	Description of setting	Setting range
F2/Clip	Reference level for generating key signals	0.0 to 108.0
F3/Gain	Key amplitude	0.0 to 200.0
F4/Density	Key density	0.0 to 100.0
F5/Invert	Key signal inversion	On, Off

Basic operations

Masking the DSK signals

These steps are taken to mask the DSK signals using the mask signal of the box pattern.

- Press the  button to light its indicator, and display the DSK menu.
- Use [F1] to display the Mask sub menu.

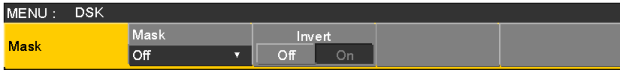

- Use [F2], and select the masking method using the Mask item.

Off	The DSK signals are not masked.
Manual	The area that is set using the Mask Adjust sub menu is masked.
4:3	The signals are masked to the 4:3 aspect ratio.

- Use [F3] to set whether to invert the mask signal using the Invert item.

On	The mask signal is inverted.
Off	The mask signal is not inverted.

- Use [F1] to display the Mask Adjust sub menu.

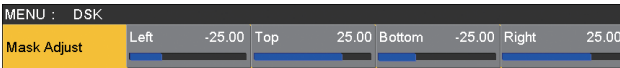

- Use [F2] to [F5] to set the area to be masked.

Operation/Parameter	Description of setting	Setting range/ Initial value
F2/ Left	DSK left position	-50.00 to 50.00/ -25.00
F3/ Top	DSK top position	-50.00 to 50.00/ 25.00
F4/ Bottom	DSK bottom position	-50.00 to 50.00/ -25.00
F5/ Right	DSK right position	-50.00 to 50.00/ 25.00

The Left setting cannot exceed the Right setting (and vice versa) and, similarly, the Top setting cannot exceed the Bottom setting (and vice versa).

<DSK mask setting> (figure shows the default values)

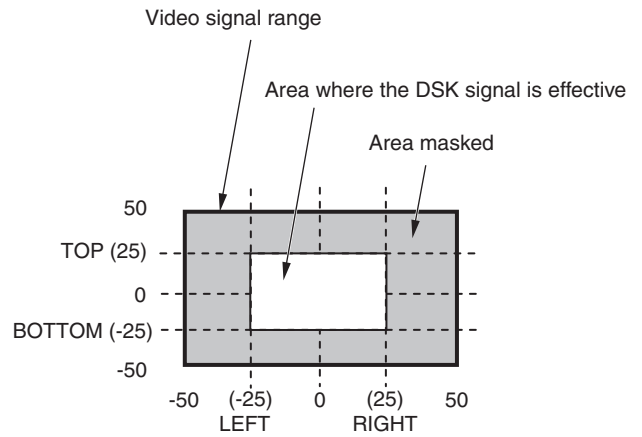

Basic operations

Key Link

Key1, Key2, and Key3 and DSK1 and DSK2 can be linked in Group1 to 4.

This function makes it possible to link the “On” or “Off” setting of the [DSK ON] button and [PinP] buttons ([PinP1 ON] and [PinP2 ON]) with the “On” or “Off” (button indicator lights or off) of the [KEY ON] button.

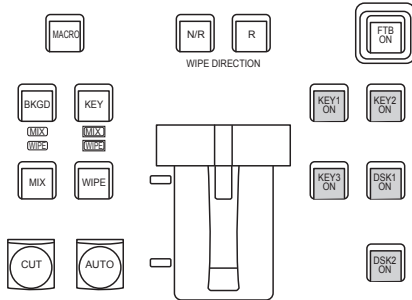

- ① Press the Config button to be used to display the menu.
- ② Use [F1] to display the Key/DSK Link1 or 2 sub menu, then use Color Group1 to 8 to set the button color linked to each of the buttons.
 - There is no linking if OFF is selected.
 - The button color for each of the buttons is set in the Color Group KEY ON and Color Group DSK/FTB ON sub menus.

MENU: Config			
Key/DSK Link1	Key1	Key2	Key3
	Off	Off	Off
Key/DSK Link2	DSK1	DSK2	
	Off	Off	

MENU: Config			
Color Group KEY ON	KEY1 ON	KEY2 ON	KEY3 ON
	Color Group1	Color Group1	Color Group1
Color Group DSK/FTB ON	DSK1 ON	DSK2 ON	FTB ON
	Color Group1	Color Group1	Color Group1

Example:

When KEY1 of Key/DSK Link1 is set to Color Group 1, then whichever of the KEY2 ON/KEY3 ON/DSK1 ON/DSK2 ON/FTB ON buttons is set to ON (illuminated), the KEY1 ON button will also be set to ON.

FTB (Fade to Black)

The user can fade out from a program image to the black screen/white screen/Still/Clip/color background screen or fade in to a program image from a black screen/white screen/Still/Clip/color background.

- ① Set the duration of the transition. Press the [TIME CAM] button to light its indicator, and display the Time menu.
- ② Use [F1] to display the FTB sub menu. As with a background transition, set the transition time. Refer to “Auto transition”.

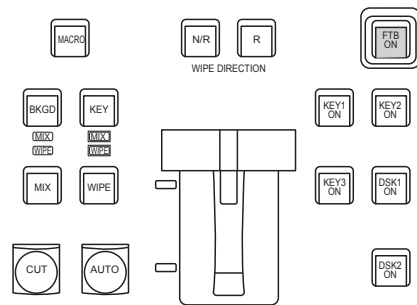

- ③ The screen fades out to the setting screen at the set transition time when you press the [FTB ON] button in the transition area. During fade-out, the indicator of the [FTB ON] button blinks in red, and it lights in red when the transition (fade-out) is completed, and the black screen is displayed.* When the [FTB ON] button is pressed with the black screen displayed, fade-in to the program image is initiated. During fade-in, the indicator of the [FTB ON] button lights in red, and it goes off when the transition (fade-in) is completed. If the [FTB ON] button is pressed at any point during a transition, the direction of the transition is reversed.

*: In the FTB status, the crosspoint button which is normally lit in red lights in amber.

Basic operations

Selecting the image

The image to be used for fading out can be selected.

- ① Press the  button to light its indicator, and display the Config menu.
- ② Use [F1] to display the Assign sub menu.

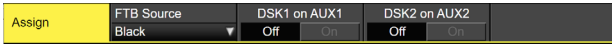

- ③ Use [F2] to select the image to appear when fading out using the FTB Source item.

Still1	The still image video memory (Still1) is used.
Still2	The still image video memory (Still2) is used. <ul style="list-style-type: none"> ● Selectable only in 2K mode.
Clip1	The moving image video memory (Clip1) is used.
Clip2	The moving image video memory (Clip2) is used. <ul style="list-style-type: none"> ● Selectable only in 2K mode.
CBGD1	The color background is used.
CBGD2	
White	White background
Black	Black background

Internal color signals

This unit supports two sets of internal color signals.

Setting the color background

The color background to be used by the bus can be set. Two methods are available: under one method the Hue (hue), Sat (color saturation) and Lum (luminance) are set, and under the other the 8 preset colors (white, yellow, cyan, green, magenta, red, blue and black) are called.

The Hue, Sat and Lum of the called colors can also be adjusted.

Adjusting the colors

- ① Press the  button to light its indicator, and display the Color Background menu.
- ② Use [F1] to display the CBGD1 Main sub menu (or CBGD2 Main sub menu).



- ③ Use [F2], [F3] and [F4] to perform the color adjustments (Hue, Sat and Lum).

■ To call the preset color

Use [F5] to select the preset color using the Load item, and press the [F5].

- When [F5] is pressed, what has been set so far is canceled and replaced with the preset color values.
- To save the values that were set before calling the preset color, refer to "Memory".

Basic operations

Setting the Wash effect

The gradation effect for color backgrounds can be set.

Selecting the Wash effect and setting the colors

- Press the  button to light its indicator, and display the Color Background menu.
- Use [F1] to display the CBGD1 Wash sub menu (or CBGD2 Wash sub menu).

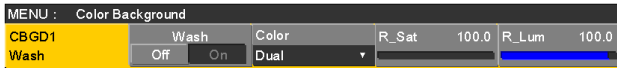

- Use [F2] to set the Wash (gradation) effect using the Wash item.

On	The gradation effect is added.
Off	The gradation effect is not added.

- Use [F3] to set the color of the Wash (gradation) effect using the Color item.

Dual	A dual-color gradation effect is added. (This results in a gradation of two colors, namely, the CBGD1 Main color and the CBGD1 Sub color.)
Rainbow	The rainbow color gradation effect is added.

- When "Dual" has been selected, use [F1] to display the CBGD1 Sub sub menu (or CBGD2 Sub sub menu), and set the sub color.



- Use [F2], [F3] and [F4] to adjust the colors (Hue, Sat and Lum).

Adjusting the Wash waveforms

- On the Color Background menu, use [F1] to display the CBGD1 Wave sub menu (or CBGD2 Wave sub menu).



- Use [F2] to select the gradation waveforms using the Pattern item.

Sine	Sine waves are selected.
Saw	Sawtooth waves are selected.

- Use [F3] to select the gradation cycle using the Cycle item.
- Use [F4] to select the gradation phase using the Phase item.
- Use [F5] to select the gradation angle using the Angle item.

Setting the Wash movements

- On the Color Background menu, use [F1] to display the CBGD1 Move sub menu (or CBGD2 Move sub menu).

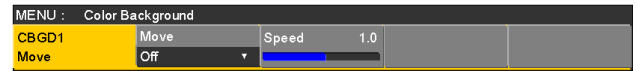

- Use [F2] to set the gradation movement using the Move item.

Off	No movement is set.
Roll	The gradations are scrolled.
Rotation	The gradations are rotated.

- Use [F3] to set the movement speed using the Speed item.

Internal color bar signal

The unit supports 1 internal color bar signal.

Test tone settings

The settings related to the test tone signals (1 kHz) output with color bar signals can be set.

- Press the  button to light its indicator, and display the System menu.
- Use [F1] to display the Test Tone sub menu.



- Use [F2] to set the test tone function in the Color Bar item.

Normal	Test tones are output at the normal volume (-12 dB).
Low	Test tones are output at lower volume (-20 dB).
Off	Test tones are not output.

Basic operations

Switching the AUX output

Selecting the AUX output materials

The output signals of the AUX buses (AUX1 to AUX4) can be selected.

- Press one of the [AUX1] to [AUX4] buttons among the AUX bus selector buttons.
The selected button lights in amber.
- Press one of the AUX bus crosspoint buttons.
The selected signal is output to the pressed [AUX1] to [AUX4] button.

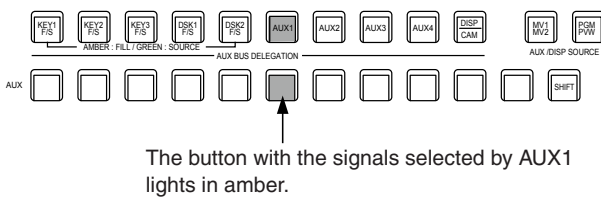

<Signals that can be selected by the AUX bus>

Name of signal	Description of signal
IN1, IN2	SDI/HDMI input signal 1, 2
SDI IN3 to SDI IN8	SDI input signal 3 to 8
IN-A1 to 4, IN B1 to 4	Option slot input signal (SDI, HDMI)
PGM	Program video signal
PVW	Preview video signal
CLN	Clean signal
MV1, MV2	Multi view display output signal 1, 2
KeyOut	Key output signal
BLACK	Black signal
CBGD1, CBGD2	Color background 1, 2
CBAR	Color bar
Still1, Still2	Video memory (still image) 1, 2 • Still2 is selectable only in 2K mode.
Clip1, Clip2	Video memory (moving image) 1, 2 • Clip2 is selectable only in 2K mode.

- When the AUX bus for which “MV” has been selected is displayed on the sub screen of the multi view display, the images are looped as if two mirrors were facing each other.

AUX1/2 transitions

The MIX transition is executed when the output signal set for AUX1/2 is switched.

- Press the [AUX1] or [AUX2] button of the AUX bus selector buttons.
The selected button and its corresponding AUX bus crosspoint button light in amber.
- Press the AUX bus crosspoint button for the output signal to be switched to.
The MIX transition is now initiated for the length of the transition time that was set using the Time menu. While the transition is underway, the transition source AUX button lights in green, and the transition destination AUX button blinks in amber. As soon as the transition is completed, the transition source AUX button goes off, and the transition destination AUX button lights in amber. Furthermore, when another signal is selected at a midway point through a transition, the transition processing continues from that midway point.

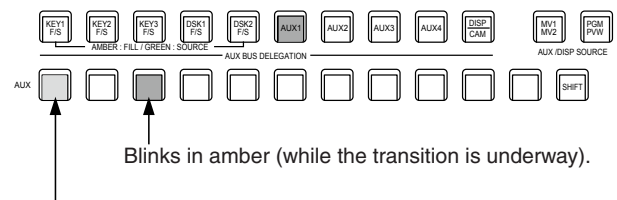

- The AUX bus transition when Shot Memory is recalled is linked to the Shot Memory dissolve time.

Basic operations

Setting enable/disable for the AUX1/2 transition

The AUX1/2 transition time and transition enable/disable can be set.

- ① Press the  button to light its indicator, and display the Time menu.
- ② Use [F1] to display the AUX1 BUS Trans sub menu.

AUX1 BUS Trans	TransTime 01s00f	Transition		
		Off On		
AUX2 BUS Trans	TransTime 01s00f	Transition		
		Off On		

- ③ When the transition time is to be set in frame units, use [F2] for the setting.
- ④ When the transition time is to be set in second units, use [F3] to set the seconds and [F4] to set the frames.
Any time from 0 to 999f can be set. The time which can be set when seconds are used as the display unit differs depending on the system format.

59.94i:	max. 33s09f	59.94p:	max. 16s39f
50i:	max. 39s24f	50p:	max. 19s49f
29.97PsF:	max. 33s09f	29.97p:	max. 33s09f
25PsF:	max. 39s24f	25p:	max. 39s24f
24PsF:	max. 41s15f	24p:	max. 41s15f
23.98PsF:	max. 41s15f	23.98p:	max. 41s15f

- ⑤ Use [F4] to set enable or disable for the transition using the Transition item.

On	Enable
Off	Disable

When disable has been set for the transition, the output signals are switched with no transition when the output signals set in AUX1 is switched.

Basic operations

Memory

■ Shot memories

The background transition pattern, PinP size, border width and other video effects can be registered in the memory and recalled. The memory used for this is referred to as a shot memory.

By setting effect dissolve, it is possible to ensure a smooth change of the switching from the current images to the images or operations registered in the shot memory.

■ Event memories

A multiple number of the video effects which can be registered in the shot memory can be registered and continuously played back while the current event and next event are interpolated to achieve the effect of a smooth transition. A group of these events are referred to as an event memory. Up to 64 events can be registered in one event memory.

- When operations such as playing are performed on event memories with a different system format to when the event memories were recorded, the operations will not be performed correctly.

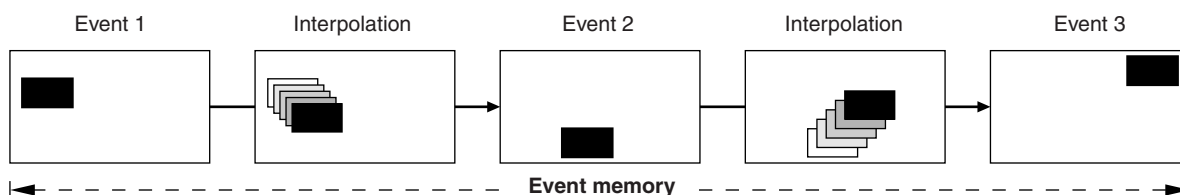

■ Macro memories

This is a function that records a series of operations by the unit and then replays them.

You can record and replay across an extensive range of functions that are not covered by the shot memory and event memory (such as input and output settings, etc.).

The recorded macros can be replayed by pressing the AUX bus crosspoint buttons or special buttons to which macros have been attached.





Up to a hundred shot memories, a hundred event memories and a hundred macro memories can be registered.

The related operations are performed using the number keys.

Page 1 to page 10 can be specified for the page numbers of the memories.

Numbers 1 to 10 can be specified as the respective memory numbers for the specified page numbers.

Selecting the memory numbers

- ① Press the [SHOT MEM], [EVENT MEM] or [MACRO] button of the memory to be selected.
- ② Press the  button.
The  button indicator lights up, and the mode for specifying the memory page number is established.
The number key of the currently selected page lights in amber.
The number keys of the page numbers in which more than one memory is registered light in green.
The indicators of the number keys of page numbers in which no memories have been registered remain extinguished.
- ③ Press the number key (1 to 10) of the page number.
When the page number is determined, the  button indicator goes off, and the mode for specifying the memory number is established.
If the page number is not going to be changed, press the  button to turn off its indicator instead of pressing the number key. This establishes the mode for specifying the memory number.
- ④ Press the number key (1 to 10) corresponding to the memory number.
(Hold down the number key when specifying a memory number to register or delete the memory.)

Basic operations

Memory registration

Applicable bus	Material selection	Transition	Pattern	Menu	Shot memory target	Event memory target	Macro memory target
ME	<ul style="list-style-type: none"> PGM/A bus PST/B bus Key Fill bus Key Source bus 	<ul style="list-style-type: none"> Fader amount Wipe direction 	<ul style="list-style-type: none"> BKGD patterns (MIX, WIPE) KEY patterns (MIX, WIPE) 	<ul style="list-style-type: none"> Background Key Chroma Key 	✓	✓	✓
DSK	<ul style="list-style-type: none"> DSK Fill bus DSK Source bus 			<ul style="list-style-type: none"> DSK 	✓	✓	✓
AUX	<ul style="list-style-type: none"> AUX bus 				✓	✓	✓
CBGD				<ul style="list-style-type: none"> Color Background 	✓	✓	—
CLIP				<ul style="list-style-type: none"> Video Memory 	—	✓	—
MENU	Menu operation			Each menu	—	—	✓
XPT	XPT selection operation			<ul style="list-style-type: none"> XPT 	—	—	✓
OTHER	<ul style="list-style-type: none"> DISP bus 				—	—	✓

✓: Valid
—: Invalid

- The following operations cannot be registered in the MENU of the macro memory.
Project File: Load, Save, Delete, Rename, Protect
SD Card: Mount, Unmount, Format, Load, Delete, Rename, Save, Create Thumbnail (for both Still and Clip)

Memory recall items

The targets for memory recall can be selected as On (recall target)/Off (not a recall target) in the Target Select 1 and 2 menus.

Target1, 2	Recall target
ME	A/B XPT, BKGD, KEY1, KEY2, KEY3
DSK	DSK1, DSK2
AUX	AUX1, AUX2, AUX3, AUX4
CBGD	CBGD1, CBGD2
CLIP	CLIP1, CLIP2

- CLIP is for the event memory only.

Basic operations

Storing the settings in the memory (Store)

Images and operations to be registered can be set and then registered in the memories.

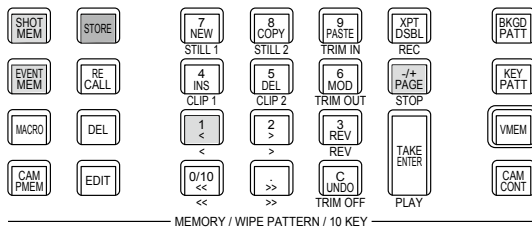

- Using the unit, set the images or operations to be kept in the memory.

To register event memory, refer to “■ Creating a new timeline” in “Editing event memory timelines”.

- Press the [SHOT MEM], [EVENT MEM] or [MACRO] button of the memory in which the images or operations are to be registered.

Depending on the operation that was performed last, the [STORE] button, [RECALL] button, [DEL] button or [EDIT] button lights.

- Select the bus (ME, DSK, AUX, CBGD, CLIP, MENU, XPT or OTHER) to be registered in the memory. From the Shot Memory menu (or Event Memory menu), select the Target Select1/2 sub menu, and then select “On”.

From the Macro menu, select the Store Select sub menu, and then select “On”.

☞ Refer to “Memory registration” and “Selecting the buses whose settings are to be registered and or played back”.

- Press the [STORE] button. The [STORE] button turns red.

- Press the  button, and press the number key (1 to 10) corresponding to the page number.

- Hold down (for 2 seconds or so) the number key (1 to 10) corresponding to the number of the memory to be registered.

When the registration is completed, the number key corresponding to the memory number lights in green.

- The number keys whose indicators are lit in green have memories already registered in them. Delete the memory corresponding to the number key concerned, and register the new memory.

- Repeat the above steps to register other kinds of settings in the memories.

Basic operations

Recalling the operations stored in the memory (Recall)

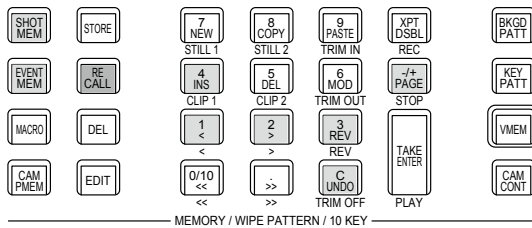

① Press the [SHOT MEM] or [EVENT MEM] button of the memory whose operations are to be recalled. Depending on the operation that was performed last, the [STORE] button, [RECALL] button, [DEL] button or [EDIT] button lights.

② Select the bus (ME, DSK, AUX, CBGD, CLIP, MENU, XPT or OTHER) to be recalled from the memory. From the Shot Memory menu (or Event Memory menu), select the Target Select sub menu, and then select "On". From the Macro menu, select the Store Select sub menu, and then select "On".

☞ Refer to "Selecting the buses whose settings are to be registered and or played back".

③ When selecting materials using the crosspoint buttons on the operation panel instead of using the registered "Material selection" item materials, press the [XPT DSBL] button to light its indicator in red.

☞ Refer to "Memory registration".

④ Press the [RECALL] button. The [RECALL] button turns amber.

⑤ Press the [PAGE] button, and press the number key (1 to 10) corresponding to the page number.

⑥ Press the number key (1 to 10) corresponding to the number for the memory whose operations are to be recalled.

- In the case of a shot memory, the video effects are recalled, and playback starts.

During playback, the number key corresponding to the memory number blinks in green.

- In the case of an event memory, the events are recalled, and playback starts.

During playback, the number key corresponding to the memory number blinks in green.

If there is a PAUSE event, playback pauses at that event, and the number key corresponding to the memory number blinks in amber.

Playback is started from the beginning each time the number key corresponding to the memory number is pressed.

Playback starts or pauses each time the [TAKE/ENTER] button is pressed.

⑦ When playback of the effects or events in the recalled memory number starts, the [UNDO] button is enabled, and its indicator lights up. If this button is pressed during playback, playback is terminated.

Basic operations

Deleting the operations stored in the memory (Delete)

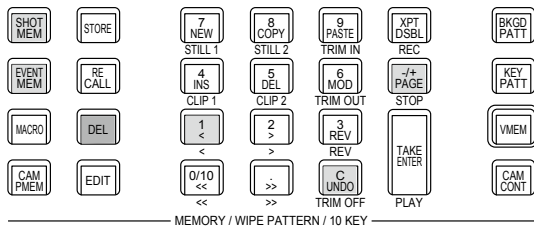

- ① Press the [SHOT MEM] or [EVENT MEM] button of the memory whose operations are to be deleted to select the memory.
The selected button lights in amber.
Depending on the operation that was performed last, the [STORE] button, [RECALL] button, [DEL] button or [EDIT] button lights.
- ② Press the [DEL] button.
The [DEL] button lights in red.
The button of the number key containing the stored operations lights in green.
 - To change a page number, press the  button, and press the number key (1 to 10) corresponding to the page number.
Next, press the number key (1 to 10) corresponding to the number of the memory whose operations are to be deleted.
- ③ Hold down (for 2 seconds or so) the number key (1 to 10) corresponding to the number of the memory whose operations are to be deleted.
The button of the pressed number key goes off.

Basic operations

Selecting the buses whose settings are to be registered and or played back

Bus selection when registering/playing back memories

Select the bus used for registering event memories, shot memories and macro memories.

- ① Press the  button to display the Event Memory menu (Shot Memory menu or Macro menu).
- ② Use [F1] to display the Target Select1, 2 sub menu.
- ③ Use [F2] to [F5] to set the items to be saved to "On".

Event Memory menu:

MENU: Event Memory						
Target	ME		DSK		AUX	
Select1	Off	On	Off	On	Off	On
Target	CBGD		CLIP			
Select2	Off	On	Off	On		

Shot Memory menu:

MENU: Shot Memory						
Target	ME		DSK		AUX	
Select1	Off	On	Off	On	Off	On
Target	CBGD					
Select2	Off	On				

Macro menu:

Store	ME		DSK		AUX	
Select1	Off	On	Off	On	Off	On
Store	MENU		XPT		OTHER	
Select2	Off	On	Off	On	Off	On

On	The bus settings are registered in the memories.
Off	The bus settings are not registered in the memories.

<Example of memory information display>

Page: 1 (1 to 10)

No.	Name	EVENT	ME	DSK	AUX	CBGD	XPT
1-1	SHOT001	1	On	On	On	On	On
1-2	SHOT002	1	On	On	On	On	On
1-3	SHOT003	1	On	On	On	On	On
1-4	SHOT004	1	On	On	On	On	On
1-5	SHOT005	1	On	On	On	On	On
1-6	SHOT006	1	On	On	On	On	On
1-7	SHOT007	1	On	On	On	On	On
1-8							
1-9							
1-10							

Registering the material selection items

Set whether or not to register the "Material selection" items of the buses.

☞ Refer to "Memory registration".

Basic operations

Setting effect dissolve (shot memory)

Switching from the current image to the image or operation stored in the shot memory can be performed smoothly.

① Press the  button to display the Shot Memory menu.

② Use [F1] to display the Path sub menu.

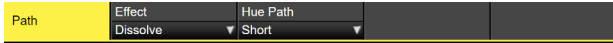

③ Use [F2] to set the effect used for switching the images using the Effect item.

Cut	The images are switched using the cut effect.
Dissolve	The images are switched using the dissolve effect.

- The dissolve effect duration is set in the Effect Dissolve sub menu which is selected in the Time menu.

④ Use [F3] to select the effect used for switching the colors using the Hue Path item.

The following colors are targeted by Hue.

- Colors of the color background
- Colors of the borders
- Colors of the edges
- Colors of the fill matte

Short	The colors are changed toward less hue on the vectorscope.
Long	The colors are changed toward more hue on the vectorscope.
CW	The Hue is changed clockwise on the vectorscope.
CCW	The Hue is changed counterclockwise on the vectorscope.

- Pressed number keys blink in green while the operation switching is underway.
- When the operation switching has been completed, the pressed number key lights in amber.
- When the Effect item is changed from “Dissolve” to “Cut” while operation is being switched, the dissolve effect is released, and the images are switched to the images of the selected shot memory in an instant.
- During the operation switching, the operation of the fader lever is canceled.
- There are cases when it is not possible to recall other memory operations during operation switching:
 - Recalling another shot memory while a shot memory is operating
 - Recalling another event memory while an event memory is operating
- It is possible to recall a shot memory while an event memory is operating or to recall an event memory while a shot memory is operating, but if there is conflict with the buses or materials played back by the event memory and shot memory, playback occurs after switching to the memory recalled last.

Basic operations

Editing event memory timelines

Insertion or modification of the events can be edited on the timelines.

■ Timeline

A timeline is a succession of events in the event memories which have been joined together on the time axis.

■ Event points and edit points

On a timeline, the position where an event has been registered is called the event point, and the event currently being edited is called the current event memory.

When there is an edit point between one event point and another, the event point before the edit point serves as the current event memory.

(Event “n” in the figure below)

<Event points and edit points>

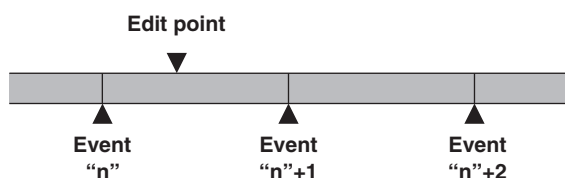

■ Event duration and total duration

The length of time as far as the next event is called the event duration.

The total of all the event durations is called the total duration. The present point in time on the timeline is called the current time.

<How times are referred to>

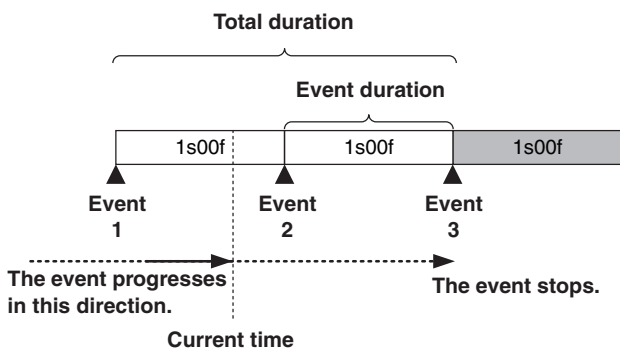

Timeline editing flow

■ Modifying registered event memories

- 1 Press the [EVENT MEM] button and light its indicator.

[EVENT MEM] button

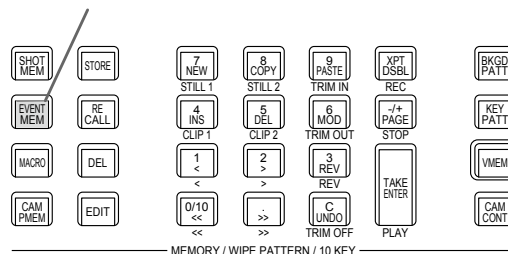

- 2 Press the [RECALL] button to light its indicator, and use the [PAGE] button and number keys (1 to 10) to select the event memory to be modified.

☞ Refer to “Recalling the operations stored in the memory (Recall)”.

- 3 Press the [EDIT] button to establish the editing mode. (At this point, the timeline of the selected event memory is copied into the work area.)

The timeline appears on the built-in display, and events can be inserted or modified.

- 4 Edit the timeline, and check what has been edited.

☞ Refer to the operations described later.

- 5 Register the event memory which has been modified.

☞ Refer to “Storing the settings in the memory (Store)”.

■ Creating a new timeline

When this operation is performed, the timeline currently in the work area is deleted.

If it is required, register it in the event memory.

- 1 Press the [EVENT MEM] button and light its indicator.

- 2 Press the [EDIT] button to light its indicator, and press



- 3 Create the new timeline.

☞ Refer to the operations described later.

- 4 Register the event memory which has just been created.

☞ Refer to “Storing the settings in the memory (Store)”.

The timeline is edited in the work area.

After editing is completed, be absolutely sure to register which has been edited.

Basic operations

Setting the playback method

■ Setting the playback mode

- 1 Press the [EVENT MEM] button and light its indicator.

[EVENT MEM] button

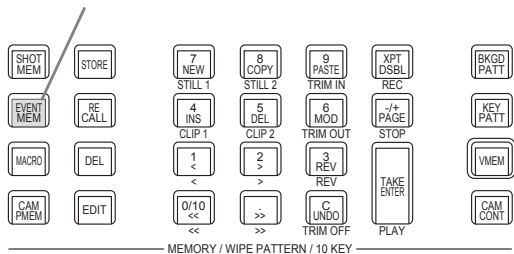

- 2 Press the [EDIT] button to establish the editing mode.
- 3 Press the [SHOT EVENT] button to display the Event Memory menu.
- 4 Use [F1] to display the Play sub menu.

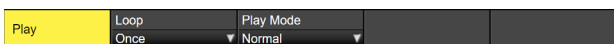

- 5 Use [F2] to set the playback mode using the Loop item.

Once	During normal playback, playback stops at the last event, and if the [TAKE ENTER] button is now pressed, the images are played back in the same direction. During reverse playback, playback stops at the first event, and if the [TAKE ENTER] button is now pressed, the images are played back in the same direction.
Loop	During normal playback, playback returns instantly from the last event to the first event, and what has been played back is repeated. During reverse playback, playback returns instantly from the first event to the last event, and what has been played back is repeated.

■ Setting the display mode

- 1 Press the [SHOT EVENT] button to display the Event Memory menu.
- 2 Use [F1] to display the Timeline sub menu.



- 3 Use [F2] to set the timeline display mode using the View item.

Normal	The timeline is displayed in a size which is one-half of the width of the built-in display screen.
Wide	The timeline is displayed in the full size (as large as the entire width) of the built-in display screen.

Basic operations

<Timeline displays (on the built-in display)>



A green “△” below the timeline indicates an event point.

A “II” indicates that “PAUSE” has been set for an event point.

If an edit point is over an event point, “△” for the event point is indicated in amber.

When “CLIP” (Clip1, Clip2) has been registered in an event, “▶” appears above the event point.

Similarly, when “GPI-Out” (GPI-O1 to GPI-O19) has been registered in an event, “◀” appears above the event point.

The timeline axis is indicated in green from the start event to the end event.

During playback, the part from the beginning to the current position is indicated in yellow.

Similarly, during reverse playback, the part from the end to the current position is indicated in yellow.

■ Number key operations

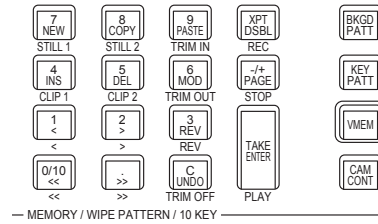

	Creates a new timeline.
	Copies events. An event is not copied if an edit point is not over the event.
	Pastes the copied events. If the edit point is an event point, the event is inserted after the event point. If the edit point is at any midway position in an event, the event is inserted at the edit point.
	Inserts events. If the edit point is an event point, the event is inserted after the event point. If the edit point is at any midway position in an event, the event is inserted at the edit point.
	Deletes events.
	Modifies events. This key cannot be operated if the edit point is not over the event point.
	Moves to the start event point.
	Moves to the end event point.
	Moves to the next event point.
	Moves to the previous event point.
	Reverses the playback direction (event numbers are put in their reverse sequence).
	Undoes the editing operation of the event. When the button is pressed, the operation performed last is canceled.
	Plays back events. When this button is operational, its indicator lights in amber. Each time it is pressed, operation is switched between playback and pause. During playback, its indicator blinks in green; during pause, it blinks in amber.

Basic operations

Inserting events (Insert)

The current setting status can be inserted as an event after the current event memory.

When an event is inserted, the numbers of the events after the current event memory are each moved up by one.

- ① Use , , and to select the event point (current event memory) which is to be inserted.
To insert the event at a midway point of an event, play back the event to the place where the event is to be inserted, and stop the edit point.
- ② Operate the panel, and create the event.
- ③ Press to insert the created event.
To cancel the event insertion, press the button.
 - When the number of events on the timeline has reached 64, no further events can be inserted.
 - When the edit point is over the event point, the newly created event is inserted with the same duration as the current event memory.
 - If the edit point is between one event point and another, the current event memory is split at the edit point position, and the newly created event is inserted.
 - When registering "CLIP" (Clip1, Clip2) to event memory, place Current time for Clip1 (or Clip2) at the beginning (from the Video Memory2 sub menu, press [F2] (LEAD)).
Some clips might not play back.

Modifying events (Modify)

Already registered events can be modified.

- ① Use , , and to select the event point of the event to be modified.
- ② Operate the panel, and modify the event.
- ③ Press to set the modified details.
To cancel the event modification, press the button.

Copying events (Copy)

Already registered events can be copied.

- ① Use , , and to select the event point of the event to be copied.
- ② Press to copy the event.

Pasting events (Paste)

Copied events can be pasted.

- ① Use , , and to select the event point where the copied event is to be inserted.
To insert the copied event between one event point and another, play back the event to the place where the copied event is to be inserted, and stop the playback.
- ② Press to paste the copied event.
To cancel the event pasting, press the button.
 - When the number of events on the timeline has reached 64, no further events can be inserted.
 - When the edit point is over an event point, the copied event is inserted with the same duration as the current event memory.
 - If the edit point is between one event point and another, the current event memory is split at the edit point position, and the copied event is inserted.

Deleting events (Delete)

Already registered events can be deleted.

- ① Use , , and to select the event point of the event to be deleted.
- ② Press to delete the event.
To cancel the event deletion, press the button.
 - Even if the edit point is midway through an event, the current event memory will be deleted.

Undoing what has been edited (Undo)

When the button is pressed, the operation performed last is canceled.

Basic operations

Setting events using the menus

■ Registering marks

Marks can be registered and events inserted at the event points.

- Pause
- Clip playback
- GPI-Out output

① Use [0/10 <<], [1 <], [2 >] and [>>] to select the event where the mark is to be registered or the event inserted.

② Press the [SHOT EVENT] button to display the Event Memory menu.

③ Use [F1] to display the Mark sub menu.

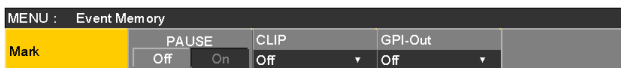

④ Use [F2] (PAUSE item), [F3] (CLIP item) or [F4] (GPI-Out item) to select the item.

PAUSE	When "On" is selected and the mark is registered in the event point, playback is paused at the mark position during event playback. "II" appears above the timeline.
CLIP	When "Clip1" or "Clip2" is selected and the mark is registered in the event point, the clip is played back at the mark position during event playback. "▶" appears above the timeline.
GPI-Out	When a GPI output port from "GPI-O1" to "GPI-O19" is selected and the mark is registered in the event point, pulse signals are output from the GPI Output port at the mark position during event playback. "⚡" appears above the timeline. • For the Config menu → GPI-Out Port 1/5 sub menu to GPI-Out Port 5/5 sub menu → Assign item, check that the selected GPI output port is set to "Event MEM".

⑤ Press [MOD] to register the mark.
In addition, press [INS] to insert the event.
To cancel the mark registration or event insertion, press the [UNDO] button.

■ Setting the event duration

The lengths of the events can be set.

① Use [0/10 <<], [1 <], [2 >] and [>>] to select the event to be modified.

② Press the [SHOT EVENT] button to display the Event Memory menu.

③ Use [F1] to display the Event Duration sub menu.

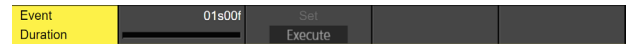

④ Use [F2] to set the event length.

⑤ Press [F3] to enter the duration.
To cancel what has been modified, press the [UNDO] button.

■ Setting the total duration

The total length of all the events from start to end can be set. When the total duration is changed, the durations of the events contained in the event memories are re-calculated using the duration ratio prior to the change. However, the shortest duration of an event cannot be shorter than one frame.

① Press the [EVENT MEM] button and light its indicator.

② Press the [RECALL] button to light its indicator, and use the [PAGE] button and number keys (1 to 10) to select the event memory to be modified.
Refer to "Recalling the operations stored in the memory (Recall)".

③ Press the [SHOT EVENT] button to display the Event Memory menu.

④ Use [F1] to display the Total Duration sub menu.



⑤ Use [F2] to set the event length.

⑥ Press [F3] to enter the duration.

• If no more events can be contained in the total duration which already has many events and which has been changed, the number of frames will be forcibly adjusted.

Basic operations

■ Setting the event switching effect (Path)

Switching from one event to another (bus switching) can be accomplished smoothly.

- Press the  button to light its indicator, and display the Event Memory menu.
- Use [F1] to display the Path sub menu.

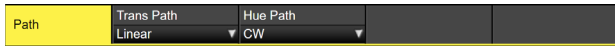

- Use [F2] and the Trans Path item to set how transitions to the next event are performed. The following transitions are available:

- Width of the borders
- Soft effect of the borders
- Positions of the images
- Trimming values

Linear	The switching from one image to another is interpolated linearly.
Spline	The switching from one image to another is interpolated over a smooth curve (a cubic function curve).
Step	The parameters are updated when the events are passed through.

- Use [F3] to select the effect when the colors are switched using the Hue Path item. The following hues are targeted.

- Colors of the color background
- Colors of the borders
- Colors of the edges
- Colors of the fill matte

Short	The colors are changed toward less hue on the vectorscope.
Long	The colors are changed toward more hue on the vectorscope.
CW	The Hue is changed clockwise on the vectorscope.
CCW	The Hue is changed counterclockwise on the vectorscope.
Step	The color changes are updated when an event is passed through.

Macro memory settings

Recording non-operation periods

- Press the  button to light its indicator, and display the Macro menu.
- Use [F1] to display the Insert Delay sub menu.

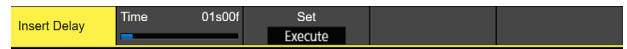

- Use [F2] to set the time of the non-operation period in the Time item.
- Use [F3] to save the time set in Step ③.

Assigning macro memories

You can assign registered macro memories to the AUX bus crosspoint buttons.

- Press the  button to light its indicator, and display the Macro menu.
- Use [F1] to display the Macro Assign1/6 to 6/6 sub menu.

Macro Assign 1/6	XPT1 No Assign	XPT2 No Assign	XPT3 No Assign	XPT4 No Assign
Macro Assign 2/6	XPT5 No Assign	XPT6 No Assign	XPT7 No Assign	XPT8 No Assign
Macro Assign 3/6	XPT9 No Assign	XPT10 No Assign	XPT11 No Assign	XPT12 No Assign
Macro Assign 4/6	XPT13 No Assign	XPT14 No Assign	XPT15 No Assign	XPT16 No Assign
Macro Assign 5/6	XPT17 No Assign	XPT18 No Assign	XPT19 No Assign	XPT20 No Assign
Macro Assign 6/6	XPT21 No Assign	XPT22 No Assign	XPT23 No Assign	XPT24 No Assign

- Use [F2] to [F5] in each of the sub menus to set the macro memories assigned to each crosspoint in the XPT1 to 24 items.

Basic operations

Changing macro memory file names

- Press the  button to light its indicator, and display the Macro menu.
- Use [F1] to display the Register sub menu.

Register	Page	No.	Rename
	1	1	Execute
- Use [F2] and [F3] to select the macro memory whose file name is to be changed.
- Use [F4] and press [F4] in the Rename item. The keyboard screen is displayed, so use it to change the file name of the macro memory.

Timeline display

This displays the number of events, used capacity, and remaining capacity on a macro memory timeline.

MACRO TIMELINE







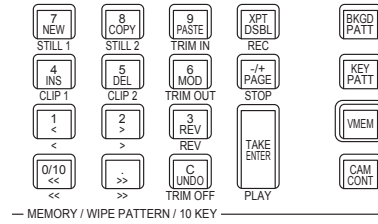

Current Event : 41
 Total Event : 41
 Used : 882
 Remain : 129166

Current Event	This displays the number of current events in the work memory.
Total Event	This displays the total number of events recorded in the work memory.
Used	This displays the capacity used in the work memory. (Units: bytes)
Remain	This displays the capacity remaining in the work memory. (Units: bytes)

Number key operations



	Creates a new timeline.
	Adds a non-operation time at the end of an event.
	Deletes the last event.
	Plays back/stops macro recording. The button turns red when recording.
	Stops macro playback.
	Plays back macro. The button turns amber when it is enabled.

Basic operations

Macro attach function

The macro registered memories can be assigned to the following playback trigger buttons:
 PGM/A bus, PST/B bus, KEY1/KEY2/KEY3 bus, DSK1/DSK2 bus, AUX1 to AUX4 bus crosspoint buttons, <KEY1 ON>/<KEY2 ON>/<KEY3 ON>/<DSK1 ON>/<DSK2 ON> button

- Press the  button to light its indicator, and display the Macro menu.
- Use [F1] to display the Attach sub menu.



- Use [F2] to enable/disable the macro attach function.
The macro attach function is enabled when ON is set.
- Press [F3] to select the Attach Setting item and assign the playback trigger button.

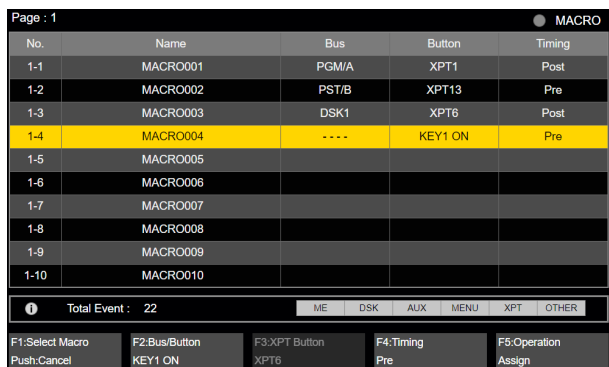

Select Macro	Use [F1] to select the macro memory.	
Cancel	Press [F1] to exit the assigning screen.	
Bus/Button	Use [F2] to select the bus button. Select the bus to have the macro attach setting from [PGM/A], [PST/B], [KEY1], [KEY2], [KEY3], [DSK1], [DSK2], [AUX1] to [AUX4], [KEY1 ON] to [KEY3 ON], [DSK1 ON], and [DSK2 ON].	
XPT Button	Use [F3] to select the XPT button. Select between [XPT1] to [XPT24]. These cannot be selected when the bus button is [KEY1 ON] to [KEY3 ON], [DSK1 ON], or [DSK2 ON].	
Timing	Use [F4] to specify the timing for playback of the macro when the macro attached button is pressed.	
	[Post]	Macro registered memory is played back once the button function has worked.
	[Pre]	Button function works once playback of the macro registered memory is finished.
	[Replace]	Macro registered memory is played back without the button function working.
Operation	Use [F5] to select whether to assign or clear the set information. Press [F5] to assign or clear.	
	[Assign]	The information for a button to which a macro was attached is assigned.
	[Clear]	The information for a button to which a macro was attached is cleared.

Basic operations

Registering memories (Register)

Shot memories and event memories can be registered. Information on the memories is displayed in the status area of the built-in display, and names can be changed.

- ① Press the  button to light its indicator, and display the Shot Memory menu (or Event Memory menu). The information of the memories is now displayed in the status area of the built-in display.
- ② Use [F1] to display the Register sub menu.



Changing the names of the memories

The names (up to 32 characters) of the memories can be changed.

- ① On the Register sub menu, use [F2] to select the page number of the registered memories using the Page item.
- ② Use [F3] to select the memory number using the No. item.
- ③ Use [F4] to display the keyboard screen.
- ④ Use the positioner, the number keys, and [F1] to [F3] to enter a name, then press [F4]. To cancel the name which has been input and close the keyboard screen, press [F5].
 Refer to “Keyboard screen operations”.

Basic operations

Video memories

This unit can be used to store still image memories (Still) and moving image memories (Clip), each in two channels. 1 channel at a time is saved in 4K mode.

- Images with key signals can be stored in the video memories (still images and moving images).
- The number of seconds that can be saved in the moving image memory depends on the system format.
- The size of the images (number of seconds) which can be stored depends on the system format (frame rate).
- The video memory data can be stored onto, and read out from, memory cards.
- Video memory data can be saved to and read from the internal storage.
- It is possible to load to the video memory from the internal storage by creating playlists.

Video memory operation		Current status					
		Clip1			Clip2		
		Recording	Playback	Stop	Recording	Playback	Stop
Still1	Recording	—	✓	✓	—	✓	✓
	Playback	—	✓	✓	—	✓	✓
Clip1	Recording	—	✓	✓	—	✓	✓
	Playback	—	✓	✓	✓	✓	✓
	Stop	—	✓	✓	✓	✓	✓
Clip2	Recording	—	✓	✓	—	✓	✓
	Playback	✓	✓	✓	—	✓	✓
	Stop	✓	✓	✓	—	✓	✓

✓: Valid
—: Invalid

Video memory input/output

The image input materials can be selected from the output signals of the AUX buses (AUX1 to AUX4).

<Image systems of the video memories>

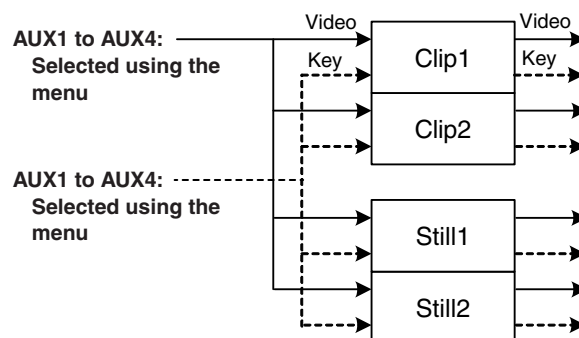

Basic operations

Recording still images (Still)

① Press the  button to light its indicator, and display the Video Memory menu.

② Use [F1] to display the Video Memory1 sub menu.

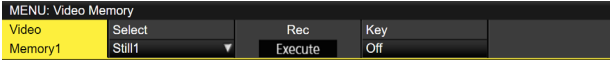

③ Use [F2] to select “Still1” or “Still2” using the Select item.

- Only Still1 can be selected in the 4K mode.

④ Use [F1] to display the Rec2 sub menu.

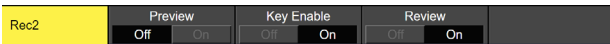

⑤ Use [F2] to set the images to appear on the built-in display using the Preview item.

On	The image appearing on the built-in display is forcibly switched to the image to be recorded (AUX1 to AUX4 selected using the VMEM Video item) instead of the material selected by the DISP bus.
Off	The image source selected by the DISP bus is displayed as a preview.

When “On” is selected for the Preview item, be aware that the following operations will occur:

- The DISP button will link with the AUX bus selection button (AUX BUS DELEGATION) of AUX1 to AUX4 selected in the VMEM Video item, which will light or turn off the buttons.
- If the material of the DISP bus is changed, the materials of the DISP bus and the selected AUX bus change at the same time.
Similarly, if the material of the selected AUX bus is changed, the material of the DISP bus changes at the same time.

⑥ Use [F2] and [F3] of Rec1 to set the images to be recorded in the video memory in the VMEM Video item.



AUX1 to AUX4	The output signals of the AUX buses (AUX1 to AUX4) are recorded as the material.
---------------------	----------------------------------------------------------------------------------

⑦ Use [F4] of Rec2 to set the review display in the Review item.

On	After the images have been recorded, the images of the video memory recorded in the AUX bus are displayed (for 2 seconds or so).
Off	The review display is not shown.

⑧ Use [F1] to display the Video Memory1 sub menu.

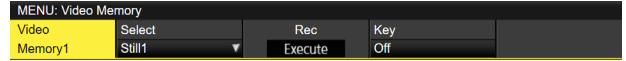

⑨ As soon as [F3] (Rec) is pressed, the still images are recorded.

- If the [VMEM] button on the right of the number keys is pressed and the video memory operation mode has been established, the operation of this button is linked with the [XPT/DSBL] button among the number keys.
- When the recording of the still images is completed, thumbnails of the still images are displayed in the thumbnail screen.

Basic operations

Recording moving images (Clip)

① Press the  button to light its indicator, and display the Video Memory menu.

② Use [F1] to display the Video Memory1 sub menu.

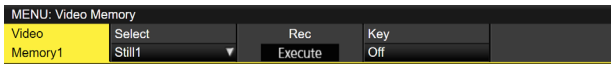

③ Use [F2] to select “Clip1” or “Clip2” using the Select item.

- Only Clip1 can be selected in the 4K mode.

④ Use [F1] to display the Rec2 sub menu.

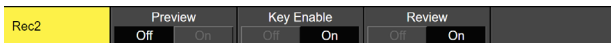

⑤ Use [F2] to set the images to appear on the built-in display using the Preview item.

On	The image appearing on the built-in display is forcibly switched to the image to be recorded (AUX1 to AUX4 selected using the VMEM Video item) instead of the material selected by the DISP bus.
Off	The image source selected by the DISP bus is displayed as a preview.

When “On” is selected for the Preview item, be aware that the following operations will occur:

- The DISP button will link with the AUX bus selection button (AUX BUS DELEGATION) of AUX1 to AUX4 selected in the VMEM Video item, which will light or turn off the buttons.
- If the material of the DISP bus is changed, the materials of the DISP bus and the selected AUX bus change at the same time. Similarly, if the material of the selected AUX bus is changed, the material of the DISP bus changes at the same time.

⑥ Use [F2] and [F3] of Rec1 to set the images to be recorded in the video memory in the VMEM Video item.

AUX1 to AUX4	The output signals of the AUX buses (AUX1 to AUX4) are recorded as the material.
---------------------	----------------------------------------------------------------------------------

⑦ Use [F4] of Rec2 to set the review display in the Review item.

On	After the images have been recorded, the images of the video memory recorded in the AUX bus are displayed (up to 4 seconds).
Off	The review display is not shown.

⑧ Use [F1] to display the Rec3 sub menu.



⑨ Use [F2] to select the recording repeat setting using the Loop item.

On	The recording of the images is continued until the stop operation is performed. If either of the following operations is performed while recording is in progress, the images are recorded up to the last frame, after which recording stops. <ul style="list-style-type: none"> • When “Off” is selected as the Loop item setting. • When [Stop] ([F5] of Video Memory sub menu) is pressed.
Off	Images are recorded up to the maximum recording time (set using the Limit items), after which recording stops automatically.

⑩ Use [F3] to set the quality of the images to be recorded using the Quality item.

Standard	Standard image quality
High	High image quality

The maximum recording time depends on the video format.

	Standard	High
2160/59.94p	15 seconds	High mode will be half the Standard mode.
2160/50p	18 seconds	
2160/29.97p	30 seconds	
2160/25p	36 seconds	
2160/23.98p, 24p	37.5 seconds	
1080/59.94p	60 seconds	
1080/50p	72 seconds	
1080/29.97psf	120 seconds	
1080/25psf	144 seconds	
1080/23.98psf, 24psf	150 seconds	
1080/59.94i	120 seconds	
1080/50i	144 seconds	
720/59.94p	120 seconds	
720/50p	144 seconds	
1080x29.97p	120 seconds	
1080x25p	144 seconds	
1080x24p	150 seconds	
1080x23.98p	150 seconds	

Basic operations

⑪ Use [F1] to set the maximum recording time using the Limit item.

⑫ Use [F1] to display the Play Mode2 sub menu.



⑬ Use [F4] to set the sound to be recorded with the Audio item.

⑭ Use [F1] to display the Video Memory1 sub menu.

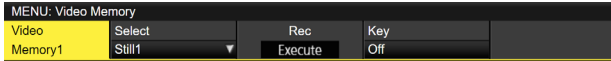

⑮ As soon as [F3] (Rec) is pressed, the recording of the moving images starts.

⑯ When [F5] (Stop) is pressed, the recording of the moving images is stopped.

- If the [VMEM] button on the right of the number keys is pressed and the video memory operation mode has been established, the operation of this button is linked with the [PAGE] button among the number keys.
- Thumbnails of moving images are displayed on the thumbnail screen.

While the thumbnails are displayed, the following information is also displayed on the thumbnail screen.

Current playback position (time), IN point position, OUT point position

- With the moving images on which the key signals are recorded, a white "O" mark is displayed for the thumbnail icons.
- The recording time is displayed in the Total Time item of the Video Memory3 sub menu. However, if trimming has been performed, the time from the IN point to the OUT point after trimming is displayed. Also, "On" is displayed for the Key item when the key signals have been recorded.

Saving to the internal storage

Data for images stored in the video memory can be retained even when the power is turned off, by saving them in the internal storage area.

Whether to automatically save the image data stored in the video memory when the data is transferred from the AUX bus or to manually save them must be set.

Notes

- If power to the unit is turned off when the saving of data has not finished, video memory data will be lost.
- Video memory data that has been saved is always restored when the power is turned on.
- If the unit is initialized, video memory that has been saved to internal storage will be lost.

① Press the [VMEM] button to light its indicator, and display the Video Memory menu.

② Use [F1] to display the Memory sub menu.



③ Use [F2] to select the saving method using the Mode item.

Auto	Automatic saving
Manual	Manual saving

④ Use [F3] to select the video memory for saving data in the internal storage area using the Select item. If "All" is selected, all video memory will be saved. Video memory that has finished being recorded is saved to the internal storage area.

⑤ Press the [F5] (Save) to save data in the internal storage area.

- [F3] (Select) and [F5] (Save) are enabled when "Manual" is selected for the Mode item.
- When "Auto" is selected for the Mode item, if video memory recording is stopped, the video memory is saved to the internal storage area immediately after recording stops. However, if the power is cut off during recording, the video memories will not be saved in the internal storage area.

Basic operations

Playing back moving images (Clip)

Establishing the playback mode

- Press the  button to light its indicator, and display the Video Memory menu.
- Use [F1] to display the Play Mode1 sub menu (or Play Mode2 sub menu).

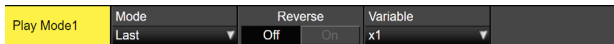

- Use [F2] to select the playback mode using the Mode item.

Lead	Operation returns to the start frame after playback.
Last	Operation stops at the end frame after playback.
Loop	The end frame and start frame are joined together and played back repeatedly.

- Use [F3] to select reverse playback using the Reverse item.

On	The moving images are played back in the reverse direction.
Off	The moving images are played back in the forward direction.

- When the [VMEM] button on the right of the number key is pressed and the video memory operation mode has been established, the operation of this button is linked with the  button among the number keys.

- Use [F4] to select the speed for variable speed playback using the Variable item.

Speeds which can be selected:
 ×1, ×2, ×4, ×8, ×1/2, ×1/4, ×1/8

- Use [F5] to select the image when operation is stopped using the Freeze item.

Frame	Stops at the frame image.
Field	Stops at the field image.

- Depending on the video format, some formats cannot be selected.

- Use [F1] to display the Play Mode2 sub menu.



- Use [F2] to set the control button used for playing back moving images in tandem with the transition operation. Use [F2] to set the Clip playback start button.

Off	Playback is not performed in tandem with the transition operation.
AUTO	The playback of the moving images is started in tandem with the operation of the [AUTO] button.
KEY1 ON	The playback of the moving images is started in tandem with the operation of the [KEY1 ON] button.
KEY2 ON	The playback of the moving images is started in tandem with the operation of the [KEY2 ON] button.
KEY3 ON	The playback of the moving images is started in tandem with the operation of the [KEY3 ON] button.
DSK1 ON	The playback of the moving images is started in tandem with the operation of the [DSK1 ON] button.
DSK2 ON	The playback of the moving images is started in tandem with the operation of the [DSK2 ON] button.
FTB ON	The playback of the moving images is started in tandem with the operation of the [FTB ON] button.
Fader	Playback of the moving images is started in tandem with the operation of the fader.

Playing back the moving images

- Press the  button to light its indicator, and display the Video Memory menu.

- Use [F1] to display the Video Memory1 sub menu.

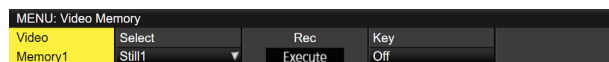

- Use [F2] to select Clip1 or Clip2 using the Select item.

- When [F4] (Play) is pressed, playback of the moving images is started.

- When the [VMEM] button on the right of the number key is pressed and the video memory operation mode has been established, the operation of this button is linked with the [TAKE/ENTER] button among the number keys.
- The current playback position (time) is displayed for the Current Time item on the Video Memory3 sub menu.

Basic operations

Moving to the first frame or last frame

- Press the  button to light its indicator, and display the Video Memory menu.
- Use [F1] to display the Video Memory2 sub menu.

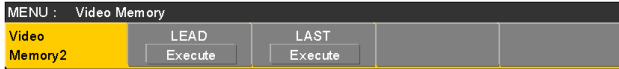



- When [F2] (LEAD) is pressed, the current position is moved to the first (head) frame; conversely, when [F3] (LAST) is pressed, the current position is moved to the last frame.

Trimming moving images

The position where the playback of the moving images is to start (IN point) and the position when it is to end (OUT point) can be set.









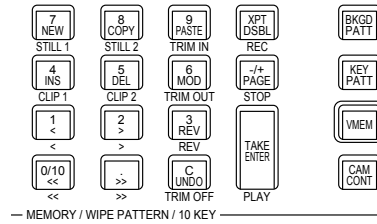





- Press the [VMEM] button on the right of the number keys to establish the video memory operation mode.
- Use [F1] (SELECT) to select Clip1 or Clip2.
- Use the number keys to stop the moving images at the position where the images are to be trimmed (IN point or OUT point).
- Trim the moving images by operating the buttons below.

	Sets the trimming IN point.
	Sets the trimming OUT point.
	Releases the trimming settings.

- Moving images that have been trimmed are played back from the IN point to the OUT point.
- When moving images are saved to a memory card, only the trimmed portion is saved.
- The same position cannot be specified for the IN point and the OUT point. The smallest unit available when trimming is performed is 2 frames.

Operations performed using the number keys



	Selects Still1 as the operation target.
	Selects Still2 as the operation target.
	Selects Clip1 as the operation target.
	Selects Clip2 as the operation target.
	Sets the trimming IN point.
	Sets the trimming OUT point.
	Releases the trimming settings.
	Plays back the moving images one frame at a time in the reverse direction.
	Plays back the moving images one frame at a time in the forward direction.
	Sets the playback direction to reverse.
	Transfers to the start frame of the moving images, and stops.
	Transfers to the end frame of the moving images, and stops.
	Plays back the moving images.
	Starts recording the moving images.
	Stops the recording or playback of the moving images.

Basic operations

Displaying thumbnails

- When the [VMEM] button located on the right of the number keys is pressed and the video memory operation mode has been established, thumbnails of the images registered in the video memories (Still1, Still2, Clip1, Clip2) can be shown on the built-in display.

Thumbnail layout

■ Still (still images)

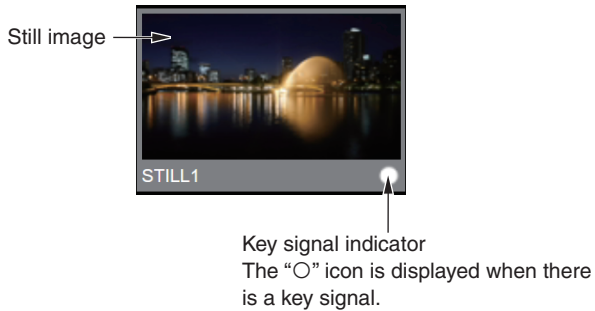

■ Clip (moving images)

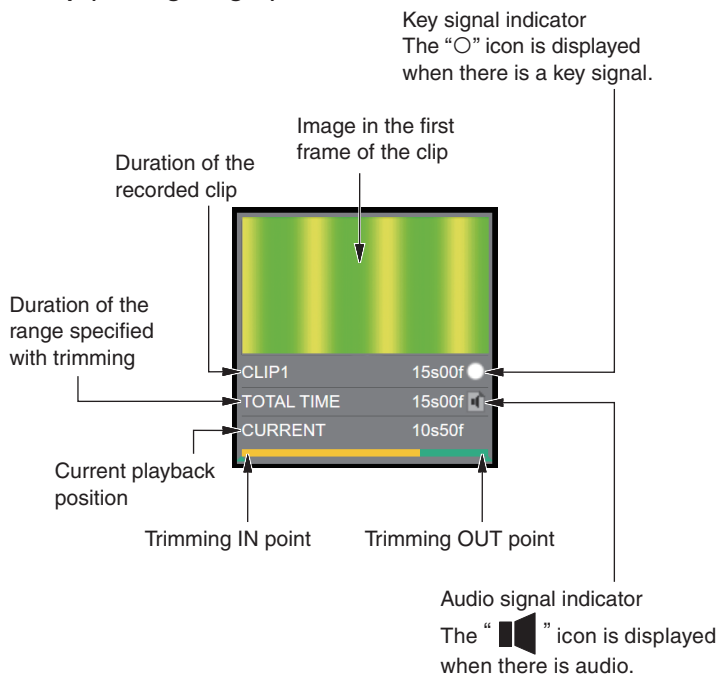

Basic operations

Internal storage management

This unit enables you to manage multiple video memories in the internal storage.

The maximum number of files that can be saved is as follows:

Still	50 files
Clip	50 files, but up to a maximum size of 20 GB

- If the internal storage does not have enough capacity to save, saving is not possible. Try deleting some existing files to free capacity in the internal storage.
- In the Clip file list screen, you can see the data size for each Clip and the used capacity and available capacity allocated for Clips in the internal storage.

Use the following operation to display the management screen used for saving and reading multiple video memory data items with the internal storage.

- 1 Press the  button to make it turn green.

Internal storage file management screen (list view)

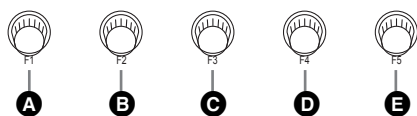
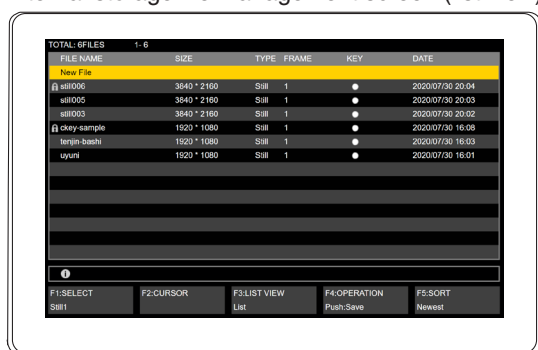

A	[F1]	SELECT	Selects the current video memory. The selection switches to Still1 → Still2 → Clip1 → Clip2 when you turn it. When the switcher mode is 4K on this unit, Still2 and Clip2 are not displayed. When Clip1/2 is selected, the maximum capacity (20 GB) and remaining capacity of the internal storage are displayed.
B	[F2]	CURSOR	Selects the items in the list. Turning it moves the cursor to the items.
C	[F3]	LIST VIEW	You can switch the screen view to “List” (a list of files) or “Thumbnail” (thumbnail view).
D	[F4]	OPERATION	Selects the operations that are performed in the internal storage management screen. The selection switches to “Save”, “Load”, “Delete”, “Rename”, and “Protect” when you turn it.
E	[F5]	SORT	The files in the list can be resorted by name, descending order by date, or ascending order by date. The selection switches to “Newest”, “Oldest”, and “Name” when you turn it.

Internal storage file management screen (thumbnail view)

You can switch between the list view and the thumbnail view by turning [F3].

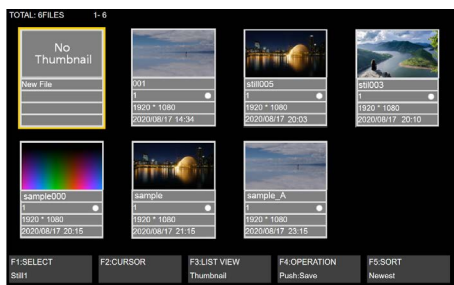

Basic operations

Saving files

Saves the Still and Clip data that has been loaded into the video memory to the internal storage.

- ① Turn [F1] to select the video memory to save.
- ② Turn [F4] to select Save and press [F4].
- ③ The keyboard screen is displayed, so use it to enter the name of the file to be saved and press [F4]. Refer to “Keyboard screen operations” (page 30).
- ④ A progress bar is displayed while saving, and saving is complete when it reaches the rightmost end.
 - If the internal storage does not have enough capacity, saving is not possible.

Recalling files

Loads the Still and Clip data that has been saved to the internal storage into the video memory.

- ① Turn [F1] to select the video memory to load.
- ② Turn [F4] to select Load.
- ③ Turn [F2] to select the Still or Clip data that you want to load from the file list.

When you select a list that cannot be loaded, [F4] is grayed out and cannot be pressed.
- ④ Press [F4] to load the target file.

A progress bar is displayed while loading, and loading is complete when it reaches the rightmost end.

Deleting files

Deletes the Still and Clip data that has been saved in the internal storage.

- ① Turn [F4] to select Delete.
- ② Turn [F2] to select the Still or Clip data that you want to delete from the file list.
- ③ Press [F4] to delete the target file.
- ④ A confirmation screen is displayed before deletion. The file is deleted when [F1] is pressed. Deleting is canceled when [F5] is pressed.
 - You cannot restore a file once you delete it. When there is no file list or you select a protected file, [F4] Delete is grayed out and cannot be selected.

Changing filenames

The filenames of the Still and Clip data saved in the internal storage can be changed.

- ① Turn [F4] to select Rename.
- ② Turn [F2] to select the Still or Clip data for which you want to change the name from the file list.
- ③ Press [F4] to change the name of the target file.
- ④ The keyboard screen is displayed, so use it to enter the new name and press [F4]. Refer to “Keyboard screen operations” (page 30).
 - You cannot restore a name once you have changed it. Do the renaming procedure again if necessary. When there is no file list or you select a protected file, [F4] Rename is grayed out and cannot be selected.

Protecting files

The Still and Clip data saved in the internal storage can be protected so that the data cannot be overwritten, deleted, or the filenames changed.

- ① Turn [F4] to select Protect.
- ② Turn [F2] to select the Still or Clip data that you want to protect in the file list.
- ③ Press [F4] to protect the target file.
 - When protected, a lock symbol is displayed in front of filenames to indicate that the files are protected. When there is no file list, [F4] Protect is grayed out and cannot be selected.
 - Operations to save, recall, delete, change the filenames, or protect files are not possible during Rec of Still or Clip.

Basic operations

Thumbnail display

Internal storage file management screen

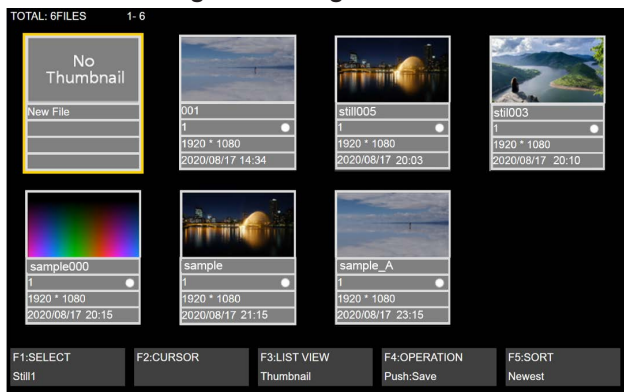

Still (still images)

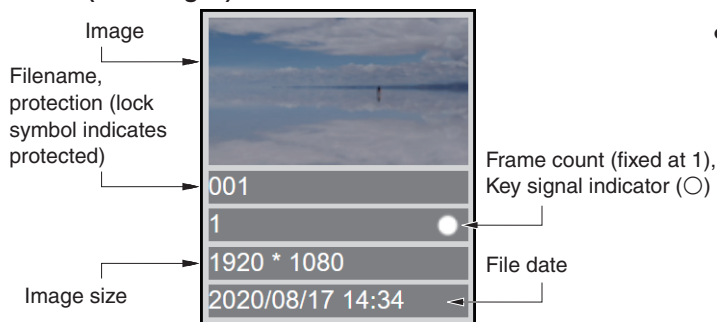

Clip (moving images)

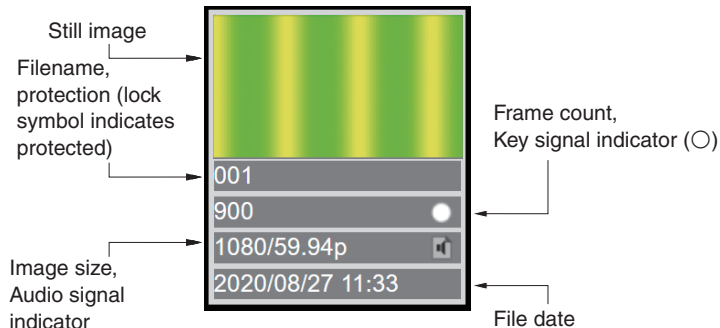

Still playlists

It is possible with this unit to set a maximum of 10 sequences for the loading of Still data saved in the internal storage to the video memory, and have the Still data loaded to the video memory accordingly.

- When a Still data file that has been set in a Still playlist is deleted from the internal storage, it is also deleted from the associated playlist.
- When a Still data file that has been set in a Still playlist has its name changed, the name in the associated playlist is also changed.
- When this unit is initialized, all Still playlists are also initialized so that all item fields will be blank.
- The playlist that is created can be saved in the project file. It is also possible to load from the project file.
- The Still playlist editing procedure can be recorded using the macro function of this unit.
- When Still data is loaded according to the playlist, the procedure that loaded the Still data selected from the internal storage is recorded in the macro.

Basic operations

Creating and editing Still playlists

Display the video memory operation screen to create and edit Still playlists.

- Press the  button to make it turn amber.

Video memory operation screen (Still playlist editing screen)

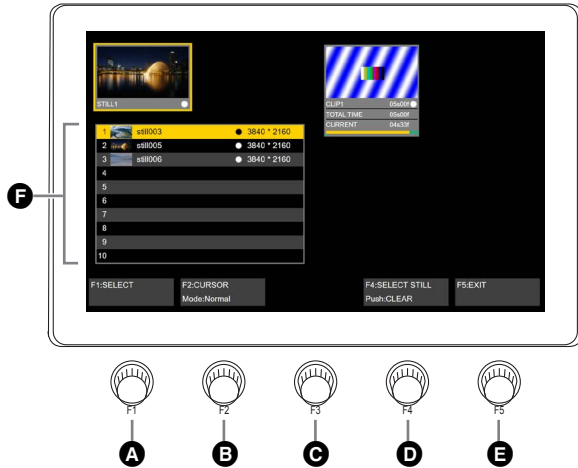

A	[F1]	SELECT	Selects the current video memory. The selection switches to Still1 → Still2 → Clip1 → Clip2 when you turn it. When the switcher mode is 4K on this unit, Still2 and Clip2 are not displayed. When Clip1/2 is selected, F playlist is grayed out.
B	[F2]	CURSOR	Select the Still data in the playlist. You can also switch the mode between Normal and Swap by pressing [F2]. <ul style="list-style-type: none"> Normal (cursor moving mode) In the Normal mode, the cursor turns yellow. By turning, the cursor for selecting Still data in the F playlist moves up and down. Swap (list swapping mode) In the Swap mode, the cursor turns turquoise. By turning, while moving up and down, the selected list is swapped.
C	[F3]	–	Not used in this screen.
D	[F4]	SELECT STILL	Selects the Still file data in the internal storage. By turning, the Still file data in the internal storage is displayed in filename order and is set in the Still playlist. Only Still data that is compatible with the switcher formats of this unit is displayed. By pressing [F4], the playlist in the cursor position is cleared.
E	[F5]	EXIT	Closes the video memory operation screen and returns the screen to the menu that was displayed immediately prior to the [VMEM] button being pressed.
F			A Still playlist. 10 Still data items can be registered. The list shows, in order from the left, the playback order, the thumbnail, the filename of the Still, whether there is a Key, and the image size.

Basic operations

Loading from the Still playlist to the video memory

Loads Still data from the Still playlist to the video memory (Still1/2).

- ① Press the  button to make it turn amber.
- ② Turn [F1] to select the video memory to load to.
 - Select Still1 or Still2. Loading of the Still data is not possible when Clip1/2 is selected.
 - Still2 is not displayed when the switcher mode is 4K.
- ③ Press number key [1] or [2] to execute load.

[1] loads in descending order according to the playlist.
([Prev.] move backward between the items of the playlist.)

[2] loads in ascending order according to the playlist.
([Next] move forward between the items of the playlist.)

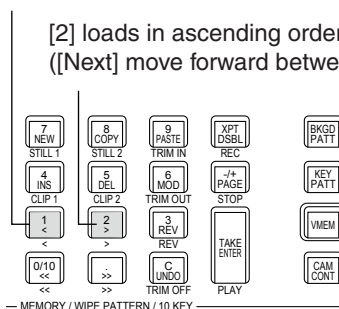

- You cannot move to No.10 when you press the [1] button when the cursor is on No.1 in the playlist.
- You cannot move to No.1 when you press the [2] button when the cursor is on No.10 in the playlist.
- Lists that cannot be played back are skipped and cannot be played back.
- Unregistered lists are skipped, the next Still list is loaded, and the cursor moves.

It is also possible to load the Still data selected in the playlist from the internal storage to the video memory.

- ④ Press [F2] to switch to Normal mode.
- ⑤ Turn [F2] to select the Still data that you want to load from the playlist.
- ⑥ Press the [TAKE/ENTER] button in the number key area to load the Still data to the video memory.

Basic operations

Memory card

The unit's video memory data and setup data can be stored on memory card.

Conversely, this data can be loaded from the memory card to the unit.

Furthermore, it is possible to upgrade the unit's software.

- It may take a while to store a moving image of a long recording time with high image quality or a still image file with high image quality on the memory card.
(Approximately 10 minutes is necessary when data with total size of about 490 MB stored in "All file" is saved to a Panasonic Class 8 SDHC memory card.)

Video memory (still image data: Still1, Still2):

<File formats supported>

Bitmap (bmp), JPEG (jpg), TARGA (tga), TIFF (tif), GIF (gif), PNG (png)

- This unit supports 24-bit uncompressed or 32-bit uncompressed TARGA files.
If any other types of TARGA files are loaded into the unit, black images will be displayed as the thumbnails, and the unit cannot recognize the files.
- Be aware that saving video memory still images on the memory card in GIF format will cause the picture quality to deteriorate.

<Applicable sizes>

4K:	3840×2160
HD/1080i:	1920×1080
HD/1080PsF:	1920×1080
HD/720p:	1280×720

- The size of images is converted automatically if it does not match any of the "applicable sizes".

Video memories (moving image data: Clip1, Clip2):

This is the original format of the unit.

Data is stored in and read from these memories.

Setup data (Set Up):

The "setup data" refers to all the data stored in the unit with the exception of the following data.

Project files can be saved.

Date, time, network settings, video memory data, shot memory data, event memory data, macro memory data

Software for upgrading (Upgrade):

The software for upgrading is loaded.

This software can be obtained from "Service and Support" on the Web site whose address is provided below:

<https://pro-av.panasonic.net/>

For the upgrade procedure, follow the steps in the directions which are contained in the download file.

Log file (Log):

Log files stored in the unit can be saved.

● Concerning memory cards

Memory cards used with the unit should conform to SD, SDHC or SDXC standards.

Be sure to format cards using the unit.

Use memory cards formatted with FAT. (NTFS formatted memory cards cannot be recognized.)

Panasonic memory cards with the following capacities can be used with the unit:

SD (from 8 MB to 2 GB)

SDHC (from 4 GB to 32 GB)

SDXC (from 64 GB to 128 GB)

For the latest information not available in the Operating Instructions, visit the following Web sites.

<https://pro-av.panasonic.net/>

- Memory cards must not be used or stored in an environment where they may be
 - Exposed to high temperatures/humidities;
 - Exposed to water droplets; or
 - Electrically charged.

Basic operations

The data is stored in the following folders on the memory card.

When data is to be loaded, first store the data in the respective folders, and then load the files.

<Data folder configuration>

Data type	Save Type item	Storage folder	Extension
Project file (project)	Project (*2)	"HS\COMM\PROJECT"	001, 002, ... (*3)
Video memory (Still file)	Still1, Still2 (*1)	"HS\COMM\IMAGE"	bmp, tga, png, jpg (jpeg), tif (tiff), gif
Thumbnail image for video memory (Still file)	Still1, Still2 (*1)	"HS\COMM\IMAGE_THUMBNAIL"	tbn, tpn, tjp, ttg, ttif, tgi
Video memory (Clip file)	Clip1, Clip2 (*1)	"HS\COMM\CLIP"	clp
Thumbnail image for video memory (Clip file)	Clip1, Clip2 (*1)	"HS\COMM\CLIP_THUMBNAIL"	png
Update file	-	"HS\UHS500\UPDATE"	50d
Log file	Log	"HS\UHS500\LOG"	log

*1: When the still image data with key signals attached is stored into the video memory, select "tga" or "png" as the file format.

The still image data of any other file format cannot be stored with attaching the key signals.

In 4K mode, only Still1 and Clip1 are available.

*2: The setup data, shot memory data, event memory data, macro memory data, still image data, video data, and still image playlists selected in the Target Select item are saved as a collection in the project file.

*3: The project file is saved in a folder created as File Name folder created under the HS\COMM\PROJECT folder.

When the project file being stored is large, the file is divided and each file is appended with a serial number extension (001, 002, etc.).

Memory card handling precautions

- Do NOT eject the memory card while the memory card access LED is lit.
When an memory card is ejected while the memory card access LED is lit, the transition may be temporarily suspended.
In addition, the data stored on the memory card may be lost.
- The data stored on memory cards may be lost as a result of misplacing the cards or performing erroneous operations, for instance. It is recommended that valuable data be stored on a computer or other device.

Basic operations

Formatting memory cards

Before using a memory card on this unit, **the memory card must first be formatted on this unit**. Executing the format means that the memory card is formatted (conforming to the SD standard) and a dedicated directory is created. (All files saved on the memory card will be erased.)

- ① Insert the memory card into the unit's memory card slot.
- ② Press the  button to light its indicator, and display the SD Card menu.
- ③ Use [F1] to display the Card Management sub menu.

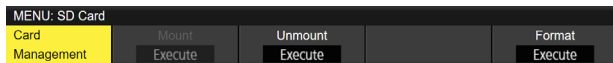

- ④ Use [F5] to execute the Format item.
The item is grayed out if a memory card is not inserted.
 - Press [F1] in the confirmation screen to format.
 - Press [F5] to cancel.

Format the memory card to use it in this unit.

This unit also supports SDHC/SDXC memory cards. You can format without distinguishing between SD memory cards, SDHC memory cards, and SDXC memory cards.

Saving data on memory cards

- ① Insert a memory card that was formatted on this unit into the memory card slot.
- ② Press the  button to light its indicator, and display the SD Card menu.
- ③ Use [F1] to display the File sub menu.

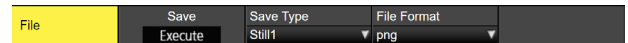

- ④ Use [F3] to select the data to save to the memory card in the Save Type item.

When saving still images:

Use [F4] to select the saving file format of still images in the File Format item.

When saving project files:

Use [F1] to select the item you want to save as the project file in the Target Select1/2 item.

Use [F2] to [F5] to set each of the items be saved to ON.



- ⑤ If the [F5] (Save) is now pressed, the file is stored on the memory card.

For the destinations where the data is stored, refer to <Data folder configuration>.

- When storing video memory still images, the file format can be selected.
On the SD Card menu, use [F1] to display the File2 sub menu, and select the format of the file to be used when storing the data on the memory card using the Format item.
- Be aware that saving video memory still images on the memory card in GIF format will cause the picture quality to deteriorate.

Basic operations

Loading data from memory cards

- Insert the memory card on which the data is stored into the memory card slot.

Load the file after its data has been stored in the each folder.

Data stored in other folders will not be recognized by the unit.

For the destinations where the data is stored, refer to <Data folder configuration>.

- On the SD Card menu, use [F1] to display the Mode sub menu.

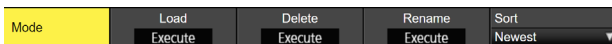

- Use [F2], and then press the [F2] using the Load item. When [F2] is pressed, the file selection screen is displayed.

<Example of what appears on the file selection screen>

FILE NAME	SIZE	TYPE	FRAME	KEY	DATE
image1224.png	3840 * 2160	Still	1	●	2020/05/13 19:04
image007_4K.png	3840 * 2160	Still	1	●	2020/05/13 19:04
image005_4K.png	3840 * 2160	Still	1	●	2020/05/13 19:04
still001.png	3840 * 2160	Still	1	●	2020/05/13 19:04
still002.png	3840 * 2160	Still	1	●	2020/05/13 19:04
still003.png	3840 * 2160	Still	1	●	2020/05/13 19:04
still004.png	3840 * 2160	Still	1	●	2020/05/13 19:04
image008_2K.png	1920 * 1080	Still	1	●	2020/05/13 19:02
image006_2K.png	1920 * 1080	Still	1	●	2020/05/13 19:02
super.png	1920 * 1080	Still	1	●	2020/05/13 19:02

- Use [F1] to select the type of file to be loaded using the SELECT item.

- Correlation between [F1] (for selecting a setting using the SELECT item) and [F3] on the file selection screen**

[F1] Settings selected using SELECT item	[F3] Displays and function
Still1, Still2, Clip1, Clip2	F3: LIST VIEW Using the [F3], it is possible to switch the screen display between "List (list files)" and "Thumbnail (display thumbnails)". ● Only Still1 and Clip1 can be selected in the 4K mode.
Upgrade	F3: The [F3] cannot be operated. On the screen, the list of files is displayed.
Project	F3: The [F3] cannot be operated. On the screen, the list of files is displayed.

- Use [F2] to select the name of the file to be loaded using the SELECT FILE item.
If the name of the file to be loaded consists of more than 23 characters, a shortened version of the filename will be displayed.

- The following alphanumeric characters and symbols can be used as the characters for filenames (see below). Files using other characters will not be displayed by the unit.
- Periods are not available in the input screen. Characters that are not available in the keyboard screen are grayed out.

<Characters which can be used for filenames>

A to Z, a to z, 0 to 9, ! # \$ % & ' () @ ^ _ ` { }

- Use [F4] to load the file.

Thumbnail display

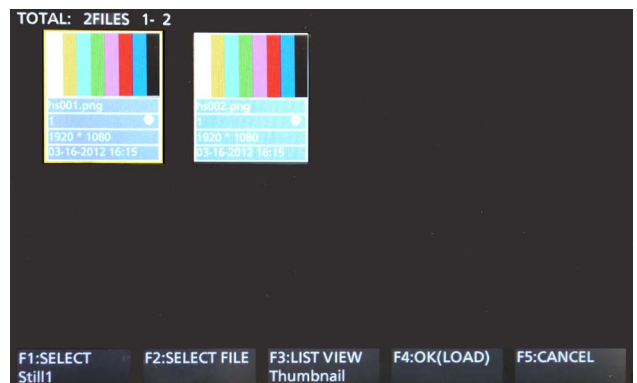

For Still thumbnails, the image is displayed in the upper portion, and the file name, KEY indicator, image size, and file date are displayed in the lower portion.

For Clip thumbnails, a still image is displayed in the upper portion, and the file name, KEY indicator, recorded time (number of frames), format, and file date are displayed in the lower portion.

A maximum of up to 100 Still thumbnails and 100 Clip thumbnails can be displayed.

On a single screen, 8 thumbnails are displayed in 2 rows of 4 thumbnails each. For more than 8 thumbnails, thumbnails are switched one row at a time.

When moving the cursor with [F2] (the SELECT item), if the cursor is at the image in the lower-right corner (or upper-left corner), moving to the right (or left) switches pages.

- Never remove the memory card while thumbnail display is in progress.

Basic operations

Changing the sort mode

The way in which the file list displayed on the file selection screen is arranged can be specified.

- ① On the SD Card menu, use [F1] to display the Mode sub menu.

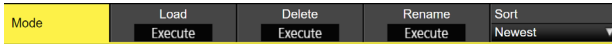

- ② Use [F5] to select the sort mode for the file selection screen using the Sort item.

Newest	The files are arranged in sequence starting with the file having the most recent registration date and time.
Oldest	The files are arranged in sequence starting with the file having the oldest registration date and time.
Name	The files are arranged in filename sequence.

Deleting files on memory cards

- ① Insert the memory card on which the data is stored into the memory card slot.
- ② On the SD Card menu, use [F1] to display the Mode sub menu.

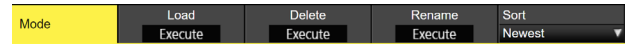

- ③ Use [F3] to select "Delete" using the Mode item, and then press the [F3].
When [F3] is pressed, the file selection screen is displayed.

<Example of what appears on the file selection screen>

FILE NAME	SIZE	TYPE	FRAME	KEY	DATE
image1224.png	3840 * 2160	Still	1	●	2020/05/13 19:04
image007_4K.png	3840 * 2160	Still	1	●	2020/05/13 19:04
image005_4K.png	3840 * 2160	Still	1	●	2020/05/13 19:04
still001.png	3840 * 2160	Still	1	●	2020/05/13 19:04
still002.png	3840 * 2160	Still	1	●	2020/05/13 19:04
still003.png	3840 * 2160	Still	1	●	2020/05/13 19:04
still004.png	3840 * 2160	Still	1	●	2020/05/13 19:04
image008_2K.png	1920 * 1080	Still	1	●	2020/05/13 19:02
image006_2K.png	1920 * 1080	Still	1	●	2020/05/13 19:02
super.png	1920 * 1080	Still	1	●	2020/05/13 19:02

F1:SELECT	F2:SELECT FILE	F3:LIST VIEW	F4:OK(DELETE)	F5:CANCEL
Still		List		

- ④ Use [F1] to select the type of file to be deleted using the SELECT item.
If the name of the file to be loaded consists of more than 23 characters, a shortened version of the filename will be displayed.
- ⑤ Use [F2] to select the name of the file to be deleted using the SELECT FILE item.
- ⑥ Use [F4] to delete the file.

Basic operations

Displaying the memory card information

- ① Insert the memory card on which the data is stored into the memory card slot.
- ② On the SD Card menu, use [F1] to display the Card Information sub menu.

Card Information	Free 0KB	Total 0KB		
------------------	-------------	--------------	--	--

Free	The memory card's remaining free space is displayed.
Total	The memory card's capacity is displayed.

Creating thumbnail images

- ① Insert the memory card on which the data is stored into the memory card slot.
- ② On the SD Card menu, use [F1] to display the Create Thumbnail sub menu.

Create Thumbnail	Still Execute	Clip Execute		
------------------	------------------	-----------------	--	--

- ③ Use [F2] to create the thumbnail for still images in the Still item.
- ④ Use [F3] to create the thumbnail for moving images in the Clip item.

Basic operations

Internal storage

The setup data for this unit can be saved as a project file in the internal storage.

Furthermore, you can also load the setup data from the internal storage to this unit.

- It may take some time when saving videos that are recorded with high image quality and over long periods of time or still image files with high image quality to the internal storage.
- The following data can be selected and saved or loaded as a project file.
Setup data, shot memory data, event memory data, macro memory data, Still video memory, Clip video memory, Still playlist
- The date, time, and network settings cannot be saved.

Project file management screen

- 1 Press the  button to light its indicator, and display the Project File menu.



- You can load, save, delete and rename project files in the internal storage using this menu screen.
You can also view the information for the project file that was most recently loaded.
- Select the following data to be loaded or saved as a project file.
Setup data, shot memory data, event memory data, macro memory data, Still video memory, Clip video memory, Still playlist

Saving project files to the internal storage

- 1 Press the  button to light its indicator, and display the Project File menu.
- 2 Use [F1] to select the item you want to save as the project file in the Target Select1/2 item.
Use [F2] to [F5] to set each of the items to be saved to ON.
- 3 Use [F1] to display the Project File sub menu.
- 4 The project file selection screen is displayed when you press [F3] (Save).

<Example project file selection screen>

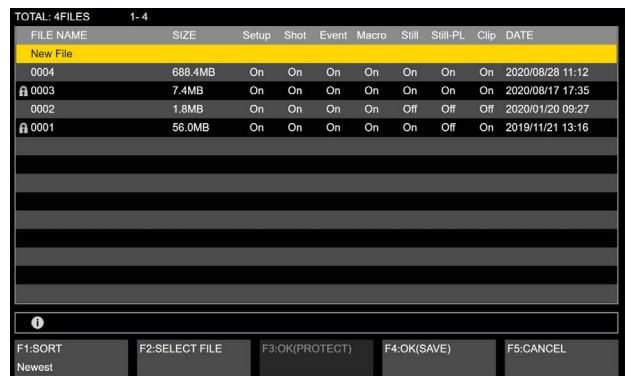

- 5 You can operate [F1] to change the file sorting order.

Newest	In the order of date and time of registration from the most recent
Oldest	In the order of date and time of registration from the oldest
Name	In the order of the names of project files

- 6 Use [F2] to select the file to be saved.
 - Select [New File] when saving a new one.
 - You can overwrite a project file that has already been saved.
 - You cannot overwrite files that have the lock mark in front of the filename.

Basic operations

⑦ The screen for entering text so that you can enter the filename is displayed when you press [F4] (SAVE). (“Keyboard screen operations” (page 30))

- Alphanumeric characters and symbols can be used for filenames. Files using other characters cannot be displayed on this unit.
- Periods are not available in the input screen. Furthermore, characters are grayed out if they are unavailable in the keyboard screen.

<Characters which can be used for filenames>

A to Z, a to z, 0 to 9, ! # \$ % & ' () @ ^ _ ` { }

⑧ Project files are saved to the internal storage when [F4] OK is pressed.

Loading project files from the internal storage

- ① Press the  button to light its indicator, and display the Project File menu.
- ② Use [F1] to select the item you want to load as the project file in the Target Select1/2 item.
Use [F2] to [F5] to turn ON the items to be loaded.
- ③ Use [F1] to display the Project File sub menu.
- ④ The project file selection screen is displayed when you press [F2] (Load).
- ⑤ In the file selection screen, use [F2] to select the file to be loaded.
- ⑥ Project files are loaded from the internal storage when [F4] (LOAD) is pressed.
- ⑦ You can protect the target file by pressing [F3] (PROTECT).
 - A lock symbol is displayed in front of the filenames of protected files.
 - Project files that are protected cannot be overwritten, deleted, or filenames changed.

Deleting project files from the internal storage

- ① Press the  button to light its indicator, and display the Project File menu.
- ② Use [F1] to display the Project File sub menu.
- ③ The project file selection screen is displayed when you press [F4] (Delete).
- ④ Use [F2] in the file selection screen to select the file to be deleted.
- ⑤ The project file is deleted from the internal storage when [F4] (DELETE) is pressed.
 - You cannot delete files that have the lock mark in front of the filename.
- ⑥ You can protect the target file by pressing [F3] (PROTECT).
 - A lock symbol is displayed in front of the filenames of protected files.
 - Project files that are protected cannot be overwritten, deleted, or filenames changed.

Basic operations

Changing the filenames of project files saved in the internal storage

- ① Press the  button to light its indicator, and display the Project File menu.
- ② Use [F1] to display the Project File sub menu.
- ③ The project file selection screen is displayed when you press [F5] (Rename).
- ④ Use [F2] in the file selection screen to select the project file for which you want to change the name.
- ⑤ The screen for entering text so that you can enter the filename is displayed when you press [F4] (RENAME). ("Keyboard screen operations" (page 30))
- ⑥ The filename of the project file saved in the internal storage is changed when you press [F4] OK.
- ⑦ You can protect the target file by pressing [F3] (PROTECT).
 - A lock symbol is displayed in front of the filenames of protected files.
 - Project files that are protected cannot be overwritten, deleted, or filenames changed.

Basic operations

Waveform monitor settings

WFM (waveform monitor) settings

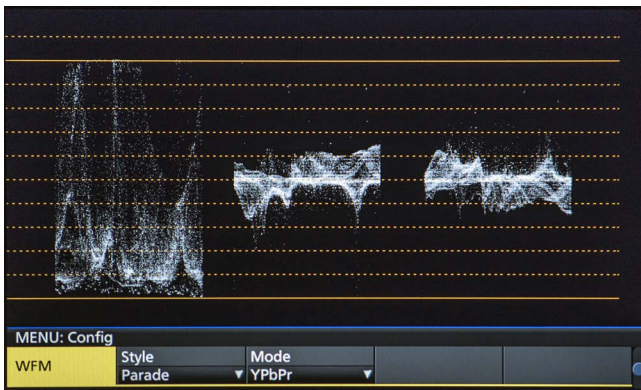

- ① Press the [WFM/VECT] button among the display mode buttons to display the waveform monitor on the built-in display.
- ② Press the  button to light its indicator, and display the Config menu.
- ③ Use [F1] to display the WFM sub menu.

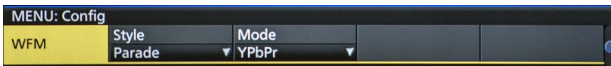

- ④ Use [F2] to select the method to be used to display the signal waveforms using the Style item.

Parade	The signal waveforms are arranged and displayed.
Overlay	The signal waveforms are superimposed onto each other and displayed.

- ⑤ Use [F3] to select the signals whose waveforms are to be displayed using the Mode item.

YPbPr	Waveforms of the Y, Pb and Pr signals are displayed.
RGB	Waveforms of the R, G and B signals are displayed.
Y	Waveforms of the Y signal only are displayed.

VECTOR (vectorscope) settings

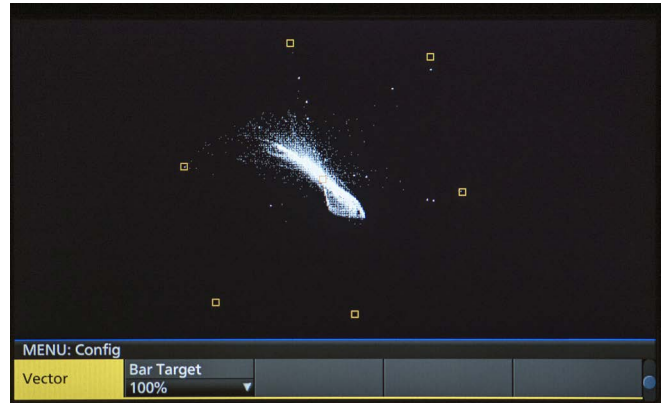

- ① Press the [WFM/VECT] button among the display mode buttons to display the vectorscope on the built-in display.
- ② Press the  button to light its indicator, and display the Config menu.
- ③ Use [F1] to display the Vector sub menu.

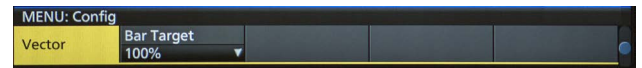

- ④ Use [F2] to select the color bar reference marker using the Bar Target item.

75%	The 75% color bar reference marker is displayed.
100%	The 100% color bar reference marker is displayed.

Input/output signal settings

Input signal settings

IN1 and IN2 are exclusive input by SDI signals or HDMI signals.

SDI IN3 to 8 are SDI signal inputs.

IN-A1 to 4, IN-B1 to 4 can be set only when one of the following optional units has been connected.

AV-UHS5M1 (SDI Input Unit)	IN-A1 to A4 and IN-B1 to B4 can be set.
AV-UHS5M3 (HDMI Input Unit)	IN-A1 to A3 and IN-B1 to B3 can be set.

Before setting the input signals, first select the input signal to be set using the Input sub menu.

- ① Press the  button to light its indicator, and display the Input menu.
- ② Use [F1] to display the Input sub menu.



- ③ Use [F2] to select the input signals using the Select item.

The menu display is switched in accordance with the input signals which have been selected. The menu title is set to "MENU: Input (signal type)/input connector (material name)".

Signal type	SDI, HDMI
Material name	Material name set in "Setting the material names".

<Example of menu (SDI)>



Input/output signal settings

<List of settings by input signal>

Input connector		Setting menu and page in this manual					
		Color Space	Status	FS	Freeze	Limited	Name
		P 108	P 109	P 109	P 110	P 110	P 111
12G SDI IN1, 12G SDI IN2 HDMI IN1, HDMI IN2 Exclusionary input	Standard SDI input ×2 lines	✓	✓	✓	✓	—	✓
	Standard HDMI input ×2 lines	✓	—	—	✓	✓	✓
12G SDI IN3, 12G SDI IN4	Standard SDI input ×2 lines	✓	✓	✓	✓	—	✓
12G SDI IN5 to 12G SDI IN8	Standard SDI input ×4 lines	✓	✓	✓	✓	—	✓
Option slot IN-A1 to IN-A4 IN-B1 to IN-B4	AV-UHS5M1 SDI input ×4 lines	✓	✓	✓	✓	—	✓
Option slot IN-A1 to IN-A3 IN-B1 to IN-B3	AV-UHS5M3 HDMI input ×3 lines	✓	—	—	✓	✓	✓

Input connector		Setting menu and page in this manual						
		Up/Down Converter	C/C	HDMI Status	HDMI Input	Scale	Camera Settings	ROI
		P 111	P 112	P 116	P 115	P 120	P 141	P 156
12G SDI IN1, 12G SDI IN2 HDMI IN1, HDMI IN2 Exclusionary input	Standard SDI input ×2 lines	—	—	—	—	—	✓	—
	Standard HDMI input ×2 lines	—	—	✓	✓	✓	✓	—
12G SDI IN3, 12G SDI IN4	Standard SDI input ×2 lines	—	—	—	—	—	✓	—
12G SDI IN5 to 12G SDI IN8	Standard SDI input ×4 lines	✓	✓	—	—	—	✓	✓
Option slot IN-A1 to IN-A4 IN-B1 to IN-B4	AV-UHS5M1 SDI input ×4 lines	✓	✓	—	—	—	✓	✓
Option slot IN-A1 to IN-A3 IN-B1 to IN-B3	AV-UHS5M3 HDMI input ×3 lines	—	✓	✓	✓	✓	✓	✓

✓: Can be set.
—: Cannot be set.

Input/output signal settings

Settings for the exclusionary input connectors

Set the exclusionary input for the SDI input connectors (12G SDI IN1, 12G SDI IN2)/HDMI input connectors (HDMI IN1, HDMI IN2).

These settings are for IN1 and IN2 which can be selected in the Select item of the Input sub menu.

① Press the  button to light its indicator, and display the Input menu.

② Use [F1] to display the Input sub menu.



③ Use [F2] to select the input signals using the Select item.

④ Use [F5] to set the input signal type in the SDI/HDMI item.

SDI IN	Selects the SDI signal input to 12G SDI IN1/2 for IN1/2. Even if HDMI signals are input, they are not input to this unit.
HDMI IN	Selects the HDMI signal input to HDMI IN1/2 for IN1/2. Even if SDI signals are input, they are not input to this unit.

Settings for the color range for input signals

Set the color range for input signals.

You can set all input signals independently.

① Press the  button to light its indicator, and display the Input menu.

② Use [F1] to display the Input sub menu.



③ Use [F2] to select the input signals using the Select item.

④ Use [F4] to set the color range in the Color Space item.

HDR BT.2020	High dynamic range, color range entered is Rec.2020.
HDR BT.709	High dynamic range, color range entered is Rec.709.
SDR BT.709	Standard dynamic range, color range entered is Rec.709.

Input/output signal settings

Checking the input signal status

You can check the status of input signals.

For SDI input signals

- Use [F1] to display the Status sub menu.

Status	Format 2160/59.94p	Audio *****	Color Space SDR Rec.709
--------	-----------------------	----------------	----------------------------

The unit automatically determines the content of input signals and displays the following information.

Format	Displays the image format information for the SDI signal being input.
Audio	Displays the audio information for the SDI signal being input.
Color Space	Displays the color space information for the SDI signal being input.

For HDMI input signals

- Use [F1] to display the HDMI Status sub menu.

HDMI Status	Size 3840x2160	Dot Clock 594.0MHz	H-Frequency 135.0kHz	V-Frequency 60.0Hz
-------------	-------------------	-----------------------	-------------------------	-----------------------

The unit automatically determines the content of input signals and displays the following information.

Size	Displays the resolution information for the HDMI signal being input.
Dot Clock	Displays the dot clock information for the HDMI signal being input.
H-Frequency	Displays the horizontal frequency information for the HDMI signal being input.
V-Frequency	Displays the vertical frequency information for the HDMI signal being input.

Setting the frame synchronizer

The frame synchronizer can be set to On or Off for each input. The HDMI input frame synchronizer is permanently On. It cannot be set from On to Off or vice versa.

- On the Input sub menu, use [F2] to select the input to be set using the Select item.
Refer to "Input signal settings".

- Use [F1] to display the FS sub menu.

FS	Mode Auto	Delay 0F
----	--------------	-------------

- Use [F3] to set the frame synchronizer in the FS item.

Off	Turns the frame synchronizer Off. The line synchronizer function operates in this case. The line synchronizer function automatically adjusts the phases of input video signals to match the phases of the horizontal sync signals.
Normal	Enables the frame synchronizer function. When a signal that is different from the system format is input, the screen turns black.
Auto	Enables the frame synchronizer function. Even when a signal that is different from the system format is input, the screen does not turn black. The video output in this case may be disrupted.

- If the output signal phase is set to [0H], Off cannot be selected as the FS item setting. If the FS item is set to Off, this changes to Normal.
- When inputting 3G-SDI Level B Mapping signals, set the frame synchronizer setting to [Auto].

Input/output signal settings

Setting the delay amount

The input signals can be delayed.

- This setting is for input signals to 12G SDI IN5 to 8 and the optional SDI input unit (IN-A1 to 4 and IN-B1 to 4).

① On the Input sub menu, use [F2] to select the input to be set using the Select item.
☞ Refer to “Input signal settings”.

② Use [F1] to display the FS sub menu.



③ Use [F3] to set the delay amount using the Delay item.

Freezing the input signals

The input signals can be frozen and used.

While signals are frozen, the tally signals of the corresponding input will not be output.

Setting freeze

① On the Input sub menu, use [F2] to select the input to be set using the Select item.

☞ Refer to “Input signal settings”.

② Use [F1] to display the Freeze sub menu.



Frame	The images are frozen frame by frame.
Field	The images are frozen field by field. This is used to freeze moving images. With interlace signals, however, diagonal lines and moving parts appear jagged.

Frame or Field can also be selected while an image is frozen.

③ Press the [F3] to freeze the input image or cancel the freeze.

If the [F3] is pressed while the display is “Off”, the video signal is frozen, and the display is set to “On”.

If the [F3] is pressed while the display is “On”, the video signal freezing is canceled, and the display is set to “Off”.

The “F” mark appears in front of the name of the material when the signals set for output of multi view displays are frozen.

- When the unit is used with the frame synchronizer function OFF, the output images may be disturbed when freezing is executed, but the frozen images will not be adversely affected.
- If, when the switcher is used with the frame synchronizer function at OFF, “On” is set as the freeze setting, the frame synchronizer function will be automatically switched to ON.

Input/output signal settings

Setting the material names

Material names can be given to the input signals. These names can be selected from the default settings or user settings.

- ① On the Input sub menu, use [F2] to select the input to be set using the Select item.
 Refer to “Input signal settings”.
- ② Use [F1] to display the Name sub menu.



- ③ Use [F2] to select the type of material names using the Type item.

Default (default settings)	Select the material names from the following: IN1, IN2, 12G SDI IN3 to 8, IN-A1 to 4, IN-B1 to 4
User (user settings)	The material names are set using up to 32 characters.

Setting the up-converter

Select the settings for SDI IN5 to SDI IN8, as well as for the up-converter that is built into the optional unit listed below:

- AV-UHS5M1 (SDI Input Unit)

- ① On the Input sub menu, use [F2] to select the input to be set using the Select item.
 Refer to “Input signal settings”.
- ② Use [F1] to display the Up/Down Converter sub menu.



- ③ Use [F2] to set the image movement detection sensitivity using the Move Detect item.

1	Toward still images
↑	↑
3	Standard
↑	↑
5	Toward moving images

- ④ Use [F3] to set the extent of the edge sharpness for the images using the Sharp item.

1	Not sharp edges
↑	↑
3	Standard
↑	↑
5	Very sharp edges

Input/output signal settings

Color Corrector

Make settings for the Color Correctors built in to SDI IN5 to SDI IN8 and the following optional units.

- On the Input sub menu, use [F2] to select the input to be set using the Select item.
 Refer to "Input signal settings".

Color Corrector settings

- Use [F1] to display the C/C Operation sub menu.



- Use [F2] to set the Color Corrector to enable (On)/disable (Off).
- Use [F3] to set the color range of the input signal in the Limit item.

Off	No limit on color range.
108	The amplitude level of each color (R, G, B) is limited to between 0% and 108%.
104	The amplitude level of each color (R, G, B) is limited to between 0% and 104%.
100	The amplitude level of each color (R, G, B) is limited to between 0% and 100%.

Process control

- Use [F1] to display the C/C Process sub menu.

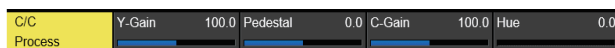

- Use [F2] to set the gain value of the Y signal in the Y-Gain item.
- Use [F3] to set the value of the pedestal level in the Pedestal item.
- Use [F4] to set the gain value of the saturation in the C-Gain item.
- Use [F5] to set the amount of change of the color hue in the Hue item.

Tone curve

Corrects the tone of the input signal.

Set the tone curve to adjust the brightness, contrast, etc., of images.

You can adjust the white balance and the color tone by separately adjusting each of the R, G, and B colors.

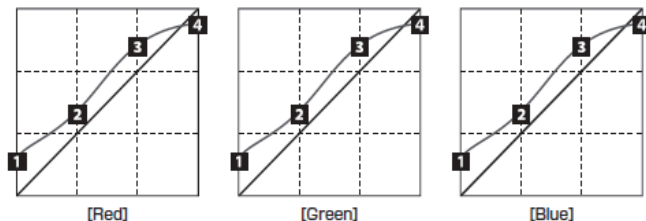

- Tone1 Black
- Tone2 Gray L
- Tone3 Gray H
- Tone4 White

Tone1 Black	Adjusts the black level.
Tone2 Gray L	Adjusts the gray Low level.
Tone3 Gray H	Adjusts the gray High level.
Tone4 White	Adjusts the white level.

- Use [F1] to display the C/C Tone1 Black sub menu.



- Use [F2] to adjust the R signal of the black level in the Red item.
- Use [F3] to adjust the G signal of the black level in the Green item.
- Use [F4] to adjust the B signal of the black level in the Blue item.
- Use [F5] to make the link settings for the adjustment value in the RGB Link item.

Off	RGB can be independently set in each of the C/C Tone1 Black, C/C Tone2 Gray L, C/C Tone3 Gray H, and C/C Tone4 White sub menus.
On	The Red setting value is set in Green and Blue in each of the C/C Tone1 Black, C/C Tone2 Gray L, C/C Tone3 Gray H, and C/C Tone4 White sub menus.

Input/output signal settings

- ⑥ Use [F1] to display the C/C Tone2 Gray L sub menu.



- ⑦ Use [F2] to adjust the R signal of the Gray Low level in the Red item.
- ⑧ Use [F3] to adjust the G signal of the Gray Low level in the Green item.
- ⑨ Use [F4] to adjust the B signal of the Gray Low level in the Blue item.
- ⑩ Use [F1] to display the C/C Tone3 Gray H sub menu.



- ⑪ Use [F2] to adjust the Gray High level of the R signal in the Red item.
- ⑫ Use [F3] to adjust the Gray High level of the G signal in the Green item.
- ⑬ Use [F4] to adjust the Gray High level of the B signal in the Blue item.
- ⑭ Use [F1] to display the C/C Tone4 White sub menu.



- ⑮ Use [F2] to adjust the R signal of the white level in the Red item.
- ⑯ Use [F3] to adjust the G signal of the white level in the Green item.
- ⑰ Use [F4] to adjust the B signal of the white level in the Blue item.

Note

- The unit joins the set black level, gray Low level, gray High level, and white level with a simplified curve to create a tone curve. The desired tone curve may not be achieved, depending on the setting values.

Gain adjustments for the color matrix

- ① Use [F1] to display the C/C Matrix R/G sub menu.



- ② Use [F2] to set the gain value of the R-G axial direction in the R-G item.
- ③ Use [F3] to set the gain value of the R-B axial direction in the R-B item.
- ④ Use [F4] to set the gain value of the G-R axial direction in the G-R item.
- ⑤ Use [F5] to set the gain value of the G-B axial direction in the G-B item.

- ⑥ Use [F1] to display the C/C Matrix B sub menu.



- ⑦ Use [F2] to set the gain value of the B-R axial direction in the B-R item.
- ⑧ Use [F3] to set the gain value of the B-G axial direction in the B-G item.

Input/output signal settings

Initializing the color corrector

- ① Use [F1] to display the C/C Setting sub menu.

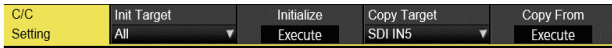

- ② Use [F2] to select the initialization target in the Init Target item.

Process	The settings in the C/C Process sub menu are initialized.
Tone	The settings in the C/C Tone1 Black, C/C Tone2 Gray L, C/C Tone3 Gray H, and C/C Tone4 White sub menu are initialized.
RGB Matrix	The settings in the C/C Matrix R/G and C/C Matrix B sub menu are initialized.
All	All are initialized.

Copying settings

You can copy the Color Corrector setting information that was set for another input.

- ① Use [F1] to display the C/C Setting sub menu.

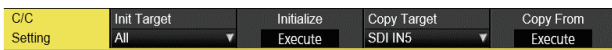

- ② Use [F4] to select the copy target in the Copy Target item.
- ③ When the Copy From item in [F5] is pressed, the settings selected as the Copy Target are copied.

Input/output signal settings

Setting the HDMI input signals

Set the HDMI input signals when the HDMI input unit (optional) or full-HD HDMI input unit (optional) has been connected.

Signals with the following resolutions can be input.

HDMI input signals	Standard (Digital)	HDMI Input Unit (Digital) AV-UHS5M3
XGA (1024x768)/60 Hz	✓	✓
WXGA (1280x768)/60 Hz	✓	✓
SXGA (1280x1024)/60 Hz	✓	✓
WSXGA+ (1680x1050)/60 Hz	✓	✓
UXGA (1600x1200)/60 Hz	✓	✓
WUXGA (1920x1200)/60 Hz	✓	✓
WQHD (2560x1440)/60 Hz	✓	✓
720/59.94p (1280x720)/59.94 Hz, 60 Hz	✓	✓
720/50p (1280x720)/50 Hz	✓	✓
1080/59.94i (1920x1080)/59.94Hz, 60 Hz	✓	✓
1080/50i (1920x1080)/50 Hz	✓	✓
1080/23.98p (1920x1080)/23.98 Hz	✓	✓
1080/24p (1920x1080)/24 Hz	✓	✓
1080/25p (1920x1080)/25 Hz	✓	✓
1080/29.97p (1920x1080)/29.97 Hz	✓	✓
1080/59.94p (1920x1080)/59.94Hz, 60 Hz	✓	✓
1080/50p (1920x1080)/50 Hz	✓	✓
2160/23.98p (3840x2160)/23.98 Hz	✓	✓
2160/24p (3840x2160)/24 Hz	✓	✓
2160/25p (3840x2160)/25 Hz	✓	✓
2160/29.97p (3840x2160)/29.97 Hz	✓	✓
2160/59.94p (3840x2160)/59.94Hz, 60 Hz	✓	✓
2160/50p (3840x2160)/50 Hz	✓	✓

✓: Can be set.
—: Cannot be set.

- If signals with any other resolutions or frequencies are input, the signals cannot be imported correctly. The images which are output at a time like this may be black or disturbed.
- These units are incompatible with the HDCP (High-bandwidth Digital Content Protection).

① On the Input sub menu, use [F2] to select the input to be set using the Select item.
☞ Refer to “Input signal settings”.

② Use [F1] to display the HDMI Input sub menu.



③ Use [F2] to select the scaling method.

Fit-V	The aspect ratio of the input images is maintained, and the size of the images is increased or reduced in accordance with the vertical resolution.
Fit-H	The aspect ratio of the input images is maintained, and the size of the images is increased or reduced in accordance with the horizontal resolution.
Full	The size of the input images is increased or reduced in accordance with the system resolution. (The aspect ratio of the input images is not kept the same. The rate at which the image size is increased or reduced in the vertical direction and in the horizontal direction differs.)

Input/output signal settings

Displaying the HDMI input signal information

These are used to display the information concerning the HDMI input signal images.
The information cannot be changed.

- ① On the Input sub menu, use [F2] to select the input to be set using the Select item.
☞ Refer to "Input signal settings".
- ② Use [F1] to display the HDMI Status sub menu.

HDMI Status	Size 3840x2160	Dot Clock 594.0MHz	H-Frequency 135.0kHz	V-Frequency 60.0Hz
-------------	-------------------	-----------------------	-------------------------	-----------------------

Size	This indicates the pixel count of the images.
Dot Clock	This indicates the dot clock frequency of the images.
H-Frequency	This indicates the horizontal frequency of the images.
V-Frequency	This indicates the vertical frequency of the images.

The formats supported are listed below.

<HDMI formats supported>

HDMI input signal			Dot clock frequency (MHz)	Frequency	
				Horizontal (kHz)	Vertical (Hz)
XGA	1024x768	Digital	65.0	48.36	60.00
WXGA	1280x768	Digital	79.5	47.78	59.87
SXGA	1280x1024	Digital	108.0	63.98	60.02
WSXGA+	1680x1050	Digital	146.2	65.29	59.95
UXGA	1600x1200	Digital	162.0	75.00	60.00
WUXGA	1920x1200	Digital	154.0	74.04	59.95
WQHD	2560x1440	Digital	241.5	88.79	59.95
720/59.94p	1280x720	Digital	74.25/1.001	44.96	60.00/1.001
720/50p	1280x720	Digital	74.25	37.50	50.00
1080/59.94i	1920x1080	Digital	74.25/1.001	33.72	60.00/1.001
1080/50i	1920x1080	Digital	74.25	28.13	50.00
1080/23.98p	1920x1080	Digital	74.2	27.0	24.00/1.001
1080/24p	1920x1080	Digital	74.2	27.0	24.00
1080/25p	1920x1080	Digital	74.2	28.1	25.00
1080/29.97p	1920x1080	Digital	74.2	33.7	30.00
1080/59.94p	1920x1080	Digital	148.5/1.001	67.50/1.001	60.00/1.001
1080/50p	1920x1080	Digital	148.5	56.25	50.00
2160/23.98p	3840x2160	Digital	297.0/1.001	53.9	24.00/1.001
2160/24p	3840x2160	Digital	297.0	54.0	24.00
2160/25p	3840x2160	Digital	297.0	56.2	25.00
2160/29.97p	3840x2160	Digital	297.0/1.001	67.40	30.00
2160/59.94p	3840x2160	Digital	594.0/1.001	134.9	60.00/1.001
2160/50p	3840x2160	Digital	594.0	112.5	50.00

- If the format of the input signals is not supported, it may not be possible to import the signals properly, and a black image or disturbed image may appear.

Input/output signal settings

Output signal settings

12G SDI OUT1 to 12G SDI OUT5 are SDI signal outputs.

HDMI OUT1, HDMI OUT2 is HDMI signal output.

OUT-A1 to OUT-A4, OUT-B1 to OUT-B4 can be set only when one of the following optional units has been connected.

AV-UHS5M2 (SDI Output Unit)	OUT-A1 to A4 and OUT-B1 to B4 can be set.
AV-UHS5M4 (HDMI Output Unit)	OUT-A1 to A3 and OUT-B1 to B3 can be set.

Before proceeding to set the output signals, first select the output signals to be set using the Output sub menu.

- ① Press the  button to light its indicator, and display the Output menu.
- ② Use [F1] to display the Output sub menu.

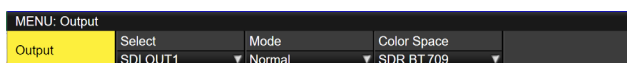

- ③ Use [F2] to select the output signals using the Select item.

The menu display is switched depending on the selected output signals.

The menu title is set to "MENU: Output (signal type)/output connector".

Signal type	SDI, HDMI
--------------------	-----------

<Example of menu (HDMI)>



<List of settings by output signal>

Output connector		Setting menu and page in this manual				
		Assign	SDI Output	HDMI Output	Down Converter	Scale
		P 118	P 118	P 119	P 120	P 120
12G SDI OUT1 to 12G SDI OUT5	Standard SDI output ×5 lines	✓	✓	—	✓ Simplified	—
HDMI OUT1, HDMI OUT2	Standard HDMI output ×2 lines	✓	—	✓	—	—
OUT-A1 to OUT-A4	AV-UHS5M2 SDI output ×4 lines	✓	✓	—	✓	—
OUT-A1 to OUT-A3	AV-UHS5M4 HDMI output ×3 lines	✓	—	✓	—	✓
OUT-B1 to OUT-B4	AV-UHS5M2 SDI output ×4 lines	✓	✓	—	✓	—
OUT-B1 to OUT-B3	AV-UHS5M4 HDMI output ×3 lines	✓	—	✓	—	✓

✓: Can be set.
—: Cannot be set.

Input/output signal settings

Assigning the output signals

The output signals can be assigned to the 12G SDI OUT connector and HDMI OUT connector.

- On the Output sub menu, use [F2] to select the output to be set using the Select item.
 Refer to “Output signal settings”.

- Use [F1] to display the Assign sub menu.



- Use [F2] to set the type of output signal using the Source item.

PGM	An image provided with the wipe, mix, key, downstream key or other effect is output at the switcher's main line output.
PVW	This is the preview output that enables the next operation to be checked before it is executed.
CLN	The clean signal (the image resulting when the key, downstream key or other effect has been removed from the PGM signal) is output.
ME PGM	ME PGM signals (images without the downstream key effects) are output.
AUX1 to 4	The signals selected by the 4 lines of AUX buses (AUX1 to AUX4) are output.
MV1, MV2	The multi view display signals are output. Multiple input signals and output signals are reduced in size and output to one screen.
KeyOut	The key signal is output.

- Use [F3] to set the output mode using the Mode item.

Normal	The same signals as the system format signals are output.
Simplified down-converter	When the system format is 2160/59.94p, the signals are output in the 1080/59.94p format.
Down-converter	This can be selected when the SDI output unit (optional: AV-UHS5M1) has been connected. When the system format is 2160/59.94p, the signals are output in the 1080/59.94p, 1080/59.94i or 720/59.94p format. When the system format is 1080/59.94p, the signals are output in the 1080/59.94i or 720/59.94p format. When the system format is 1080/59.94i, the signals are output in the 720/59.94p format. When the system format is 2160/29p, 25p, 24p, or 23p, they are output as 1080/29psf, 25psf, 24psf, and 23psf, respectively.

Setting the SDI output color range

The color range can be set for the SDI output signal images.

- You can set all output signals independently.

- On the Output sub menu, use [F4] to set Color Space.

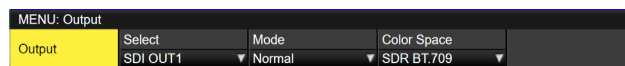

HDR BT.2020	High dynamic range, color range output is Rec.2020.
HDR BT.709	High dynamic range, color range output is Rec.709.
SDR BT.709	Standard dynamic range, color range output is Rec.709.

Input/output signal settings

Setting the HDMI output signals

Set the HDMI output signals of the standard output (HDMI OUT) and the HDMI output signals if the HDMI output unit (optional) has been connected.

- ① On the Output sub menu, use [F2] to select the output to be set using the Select item.
 ☞ Refer to “Output signal settings”.
- ② From the Output sub menu, use [F4] to set the output color range in the Color Space item.

HDR BT.2020	High dynamic range, color range output is Rec.2020.
HDR BT.709	High dynamic range, color range output is Rec.709.
SDR BT.709	Standard dynamic range, color range output is Rec.709.

- ③ Use [F1] to display the Assign sub menu.



- ④ Use [F2] to set the type of output signal using the Source item.

PGM	An image provided with the wipe, mix, key, downstream key or other effect is output at the switcher's main line output.
PVW	This is the preview output that enables the next operation to be checked before it is executed.
CLN	The clean signal (the image resulting when the key, downstream key or other effect has been removed from the PGM signal) is output.
ME PGM	ME PGM signals (images without the downstream key effects) are output.
AUX1 to 4	The signals selected by the 4 lines of AUX buses (AUX1 to AUX4) are output.
MV1, MV2	The multi view display signals are output. Multiple input signals and output signals are reduced in size and output to one screen.
KeyOut	The key signal is output.

The settings below are possible when an HDMI Output Unit (optional) is connected.

- ⑤ Use [F1] to display the HDMI Output sub menu.
- ⑥ Use [F2] to select the resolution of the images to be output using the Size item.

Auto	The equipment information of the output destination is captured by the HDMI signals, and the images are output at the optimum resolution.
XGA	(1024 × 768) / 60 Hz
WXGA	(1280 × 768) / 60 Hz
SXGA	(1280 × 1024) / 60 Hz
WXGA+	(1680 × 1050) / 60 Hz
UXGA	(1600 × 1200) / 60 Hz
WUXGA	(1920 × 1200) / 60 Hz
WQHD	(2560 × 1440) / 60 Hz
Native	Same format as the system format is output.

- ⑦ Use [F3] to set the output color space in the Color item.

Auto	Device information about the connection destination is obtained via the HDMI signal, and output uses the optimum color space accordingly.
RGB	The color space is set with the RGB format.
YUV444	The color space is set with the Y, Cb, Cr at 4:4:4. (With this method, for each 4 horizontal pixels, 4 pixels each are sampled of the luminance component and 2 color difference components)
YUV422	The color space is set with the Y, Cb, Cr at 4:2:2. (With this method, for each 2 horizontal pixels, 1 pixel each is sampled of the color difference components, and each pixel is sampled of the luminance component)

Input/output signal settings

⑧ Use [F4] to select the scaling method using the Scale item.

Fit-V	The aspect ratio of the output images is maintained, and the size of the images is increased or reduced in accordance with the vertical resolution. (Black bands are inserted into the areas where there are no images. The protruding parts of the images are cropped.)
Fit-H	The aspect ratio of the output images is maintained, and the size of the images is increased or reduced in accordance with the horizontal resolution. (Black bands are inserted into the areas where there are no images. The protruding parts of the images are cropped.)
Full	The size of the output images is increased or reduced in accordance with the system resolution.
Fullx80%	The size of the output image is increased or reduced in accordance with the 80% size of the system resolution.
Fullx90%	The size of the output image is increased or reduced in accordance with the 90% size of the system resolution.

- The aspect ratio is not maintained at the Full, Fullx80% or Fullx90% setting. The rate at which the image size is increased or reduced in the vertical direction and in the horizontal direction differs.

⑨ Use [F5] to set the image movement detection sensitivity using the Move Detect item.

1	Toward still images
↑	↓
3	Standard
↑	↓
5	Toward moving images

Setting the down-converter (optional)

Select the settings for the down-converter that is built into the SDI output unit (AV-UHS5M2).

- ① On the Output sub menu, use [F2] to select the output to be set using the Select item.
☞ Refer to "Output signal settings".
- ② Use [F1] to display the Down Converter sub menu.
- ③ Use [F2] to set the delay time of the output using the Delay item.

Minimum	Output is with the minimum delay of the system. Refer to "Adjusting the output signal phase" for the size of phase delays.
1F Fix	The image is output in-phase with a delay of 1 frame from the system image (HD).

- ④ Use [F3] to set the extent of the edge sharpness for the images using the Sharp item.

1	Standard
↑	↓
5	Very sharp edges

Input/output signal settings

Setting the sync signals

The sync signals to be used by the system can be selected.

External sync:

For synchronization with an external sync signal (gen-lock).

The reference input signal is looped through and output.

BB	Black burst signal (vertical phase of 0H)
BB Advanced	Black burst signal Vertical phase of 90H when the 59.94i or 59.94p format is selected; vertical phase of 75H when the 50i or 50p format is selected
Tri-level sync	Tri-level sync signal (vertical phase of 0H)
Internal	For synchronization with an internal reference signal (INT). The REFOUT signal (black burst signal) is output from the two reference connectors. • This cannot be selected when the system format is 1080/24PsF.

- When the format is 1080/24PsF, only Tri-level sync can be selected.
- This unit supports synchronization signals for field frequencies that are same as those of the system format.
When the unit is set to the 1080/23.98PsF format, however, the unit also supports black burst signals with 10F-1D (compliant with the SMPTE318M standard).

- ① Press the  button to light its indicator, and display the System menu.
- ② Use [F1] to display the Reference sub menu.



- ③ Use [F2], select the sync signal using the Sync item, and press the [F2] to enter the selection.
- ④ Use [F3] to select the setup level of the black burst signal in the internal synchronization mode using the BB Setup item.
This setting takes effect when the video system is 59.94i or 59.94p.
The setup level is fixed at 0 IRE when the system is 50i or 50p.
- ⑤ The genlock status is displayed in the Gen Lock item.

Locked	Synchronized with the external sync signal or internal reference signal.
UnLock	Not synchronized with the external sync signal or internal reference signal.

Adjusting the output signal phase

The phase of the output video signals can be adjusted.

- ① Press the  button to light its indicator, and display the System menu.
- ② Use [F1] to display the Output Phase sub menu.

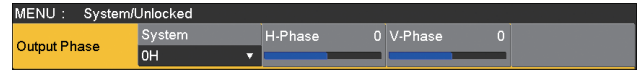

- ③ Use [F2], and select "0H" or "1H" using the System item.

0H	The output video signals are output to the system Reference signal with using in-phase. The frame synchronizer function is ON for all input signals.
1H	The output video signals are output to the system Reference signal with 1H delay. When the frame synchronizer function is ON, the output video signals are output with 1 frame + 1H delay.

- ④ Use [F3] to adjust H phase using the H-Phase item. H-Phase can be adjusted within a range of -0.50H to +0.49H.
 - The setting displayed on the menu differs depending on the system format.
- ⑤ Use [F4] to adjust V phase using the V-Phase item. V-Phase can be adjusted within a range of -100H to +100H.

Input/output signal settings

<Phase adjustment setup>

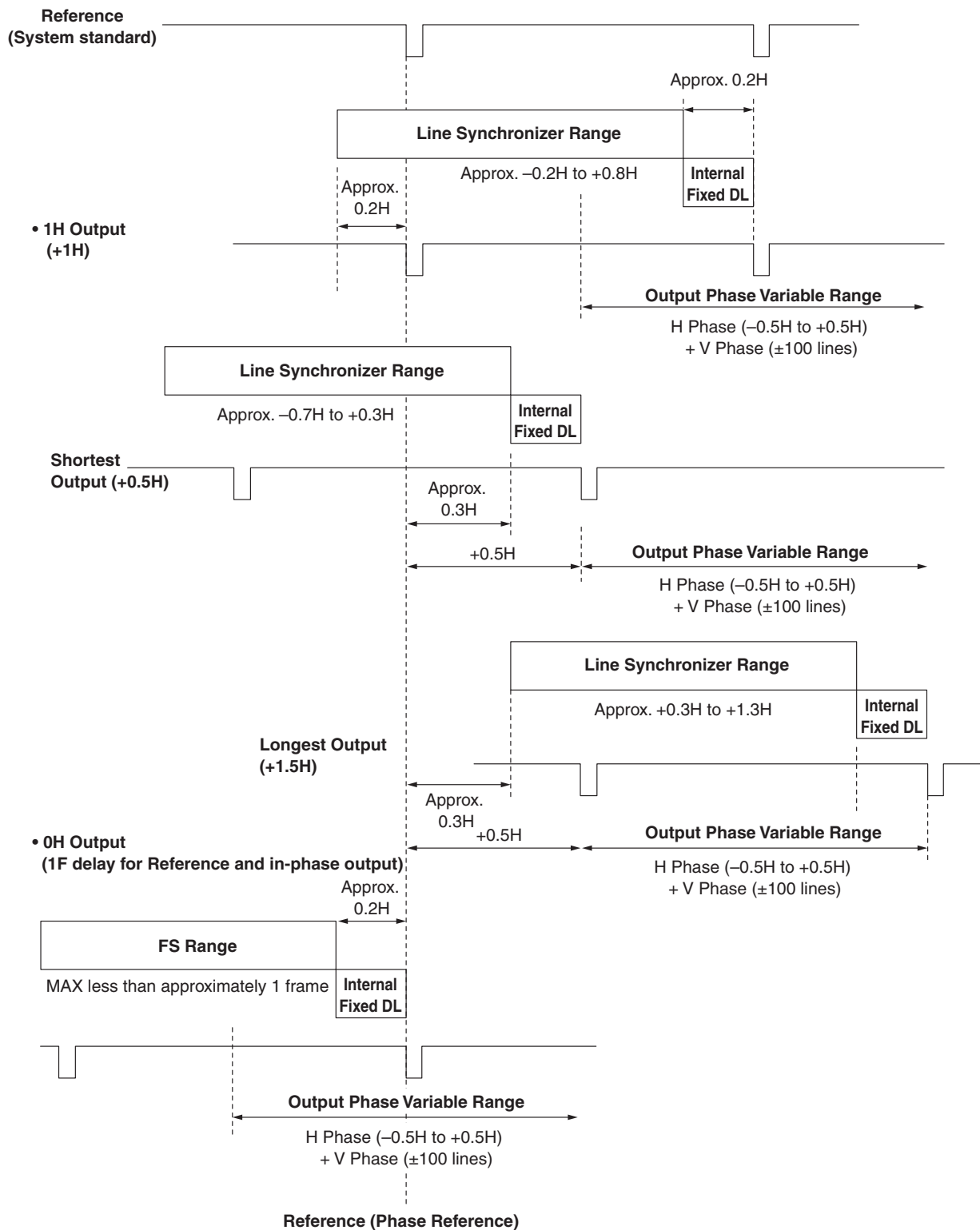

Line Synchronizer Range: Range for automatic phase adjustment.

Input/output signal settings

<Phases and delay amounts of input/output signals during HD format use>

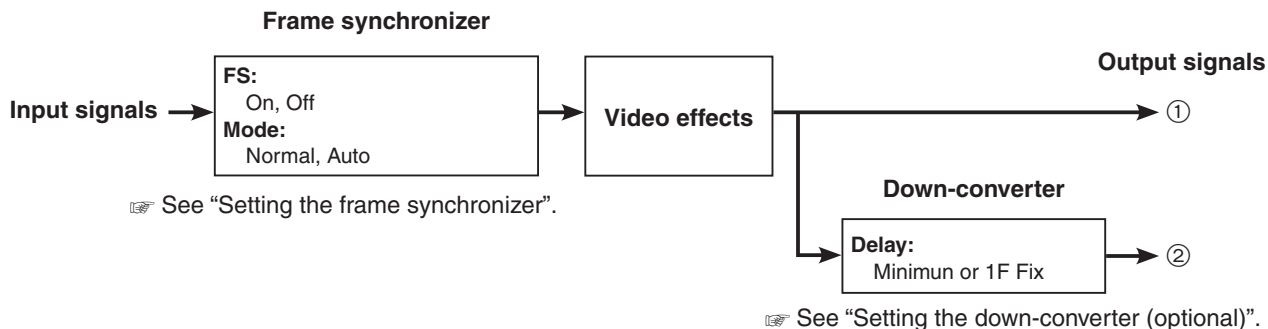

Output Phase	Input		Non-synchronized input	Output signal ① Normal		Output signal ② Down Converter (Minimum)		Output signal ② Down Converter (1F Fix)		
	System	Mode		FS	Phase	Delay amount	Phase	Delay amount	Phase	Delay amount
Sync signal (Reference): Black burst signal (BB), tri-level sync signal (Tri-level sync), internal reference signal (Internal)										
1H	Normal	Normal	Off	Not possible	Reference+1H	1H	①+90H	1H+90H	In-phase with ①	1H+1F
	Normal	Normal	On	Possible	Reference+1H	Max. 1F+1H	①+90H	Max. 1F+1H+90H	In-phase with ①	Max. 2F+1H
	Auto	Auto	On (Forced)	Possible						
0H (Example 1)	Normal/ Auto	Normal/ Auto	On (Forced)	Possible	In-phase with Reference	Max. 1F	①+90H	Max. 1F+90H	In-phase with ①	Max. 2F
Sync signal (Reference): Black burst signal (BB Advanced)										
1H	Normal	Normal	Off	Not possible	Reference -90H+1H	1H	①+90H	1H+90H	In-phase with ①	1F+1H
	Normal	Normal	On	Possible	Reference -90H+1H	Max. 1F-90H+1H	①+90H	Max. 1F+1H	In-phase with ①	Max. 2F-90H+1H
	Auto	Auto	On (Forced)	Possible						
0H (Example 2)	Normal/ Auto	Normal/ Auto	On (Forced)	Possible	Reference -90H	Max. 1F-90H	①+90H (In-phase with Reference)	Max. 1F	In-phase with ①	Max. 2F-90H

- For 1080/50i and 720/50p, the 90H indicated above becomes 75H.
- Conversion based on the HD format applies for 1H.
- When DVE effect and PinP effect have been used as the video effects, the output signal is delayed by +1F.
- When images are output to a multi view display, they are delayed by +1F.

Input/output signal settings

<Phase relationship between input signals and output signals>
(for 1080/59.94i format)

(Example 1)

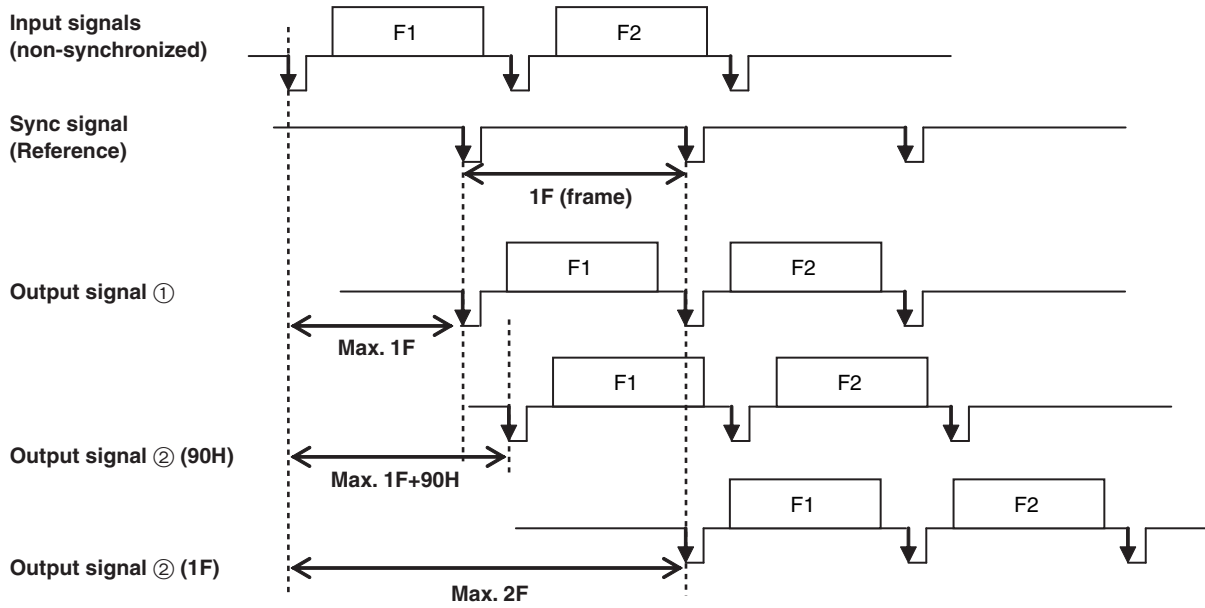

(Example 2)

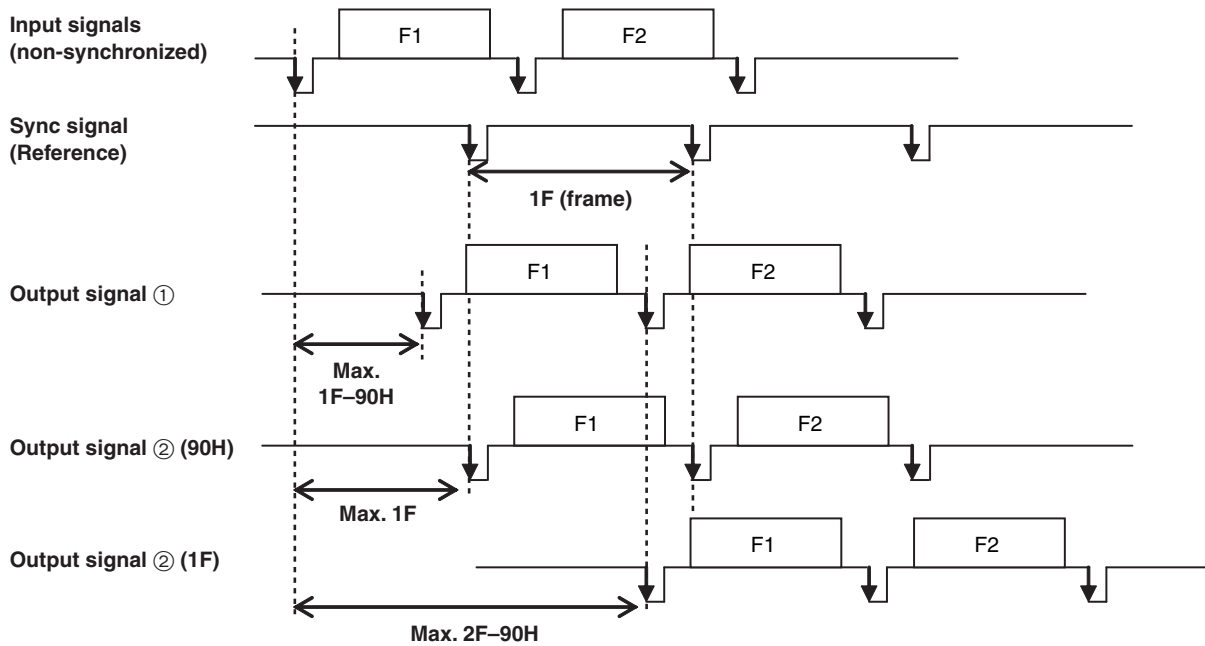

Input/output signal settings

Setting the multi view display

Setting the screen layout

You can select one of the following 10 patterns for the screen layout.

The multi view display of this unit supports MV1 and MV2.

You can select one of these to display on the built-in display.

4Split	5-aSplit	5-bSplit	6-aSplit	6-bSplit
9Split	10-aSplit	10-bSplit	12Split	16Split

Display of the following signals can be assigned to sub scens 1 to 16.

Signals that can be assigned

IN1, IN2, SDI IN3 to 8, IN-A1 to 4, IN-B1 to 4, Black, CBGD1, CBGD2, Still1V, Still1K, Still2V, Still2K, Clip1V, Clip1K, Clip2V, Clip2K, PGM, PVW, CLN, ME PGM, Key Out, MV1, MV2, AUX1 to 4, Clock

- ① Press the  button to light its indicator, and display the Multi View Display menu.
- ② Use [F1] to display the MV Split sub menu.
- ③ Use [F2] to set the split-screen display mode using the Split item.
- ④ Use [F3] to set the size mode for the split screen in the Size item.

Fit	The sizes of the split frame and the split screen will be the same.
SQ	The sizes of the split frame and the split screen will be smaller, and the material name, level meter, etc., are displayed on the outside of the split screen.

- ⑤ Use [F1] to display the MV Pattern 1/4 to MV Pattern 4/4 sub menus.
 - ⑥ Use [F2] to [F5] to set the names of the signals to be displayed on the sub screens (1 to 16).
- When an input signal (IN1, IN2, SDI IN3 to 8, IN-A1 to 4, IN-B1 to 4) is selected, the display of the material name set in Input menu → Name sub menu depends on the characters or symbols used.
 - When AUX buses (AUX1 to 4) are selected as the input signal, the material name displayed inside [] depends on the characters and symbols.
 - When the AUX bus for which “MV” has been selected is displayed on the sub screen of the multi view display, the images are looped as if two mirrors were facing each other.
 - 12 split frames cannot be selected for 720p.

<Display modes>

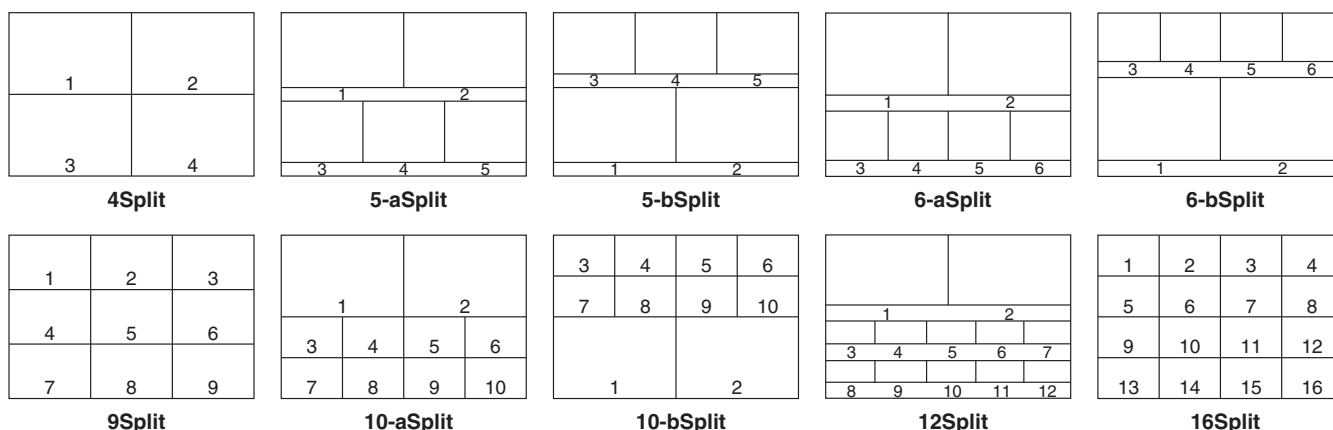

Input/output signal settings

Setting the split frame and characters

Set the frame, character brightness and background of the split screens to be displayed on the multi view display.

- Press the  button to light its indicator, and display the Multi View Display menu.

- Use [F1] to display the MV Frame sub menu.

MV Frame	Frame LUM75%	Character LUM75%	Label Off On
----------	-----------------	---------------------	-----------------

- Use [F2] to set the split frame brightness and split frame display using the Frame item.

LUM0%, LUM25%, LUM50%, LUM75%, LUM100%	Select one of these settings for the brightness of the split frame (gray scale).
Off	The split frame is not displayed.

- Use [F3] to set the character brightness and character display using the Character item.

LUM0%, LUM25%, LUM50%, LUM75%, LUM100%	Select one of these character (gray scale) brightness settings.
Off	The characters are not displayed. Neither is the character background shown.

- Use [F4] to set whether the character background (half-tone) is to be displayed using the Label item.

On	The character background is displayed.
Off	The character background is not displayed.

- This is enabled when Fit mode is on.

Setting the tally displays

Set the tally displays to be superimposed onto the split frame of the multi view display.

You can set 4 tally groups on this unit, and you can set materials for each of the groups.

Tally groups 1 and 2 can be displayed on the multi view display.

- Press the  button to light its indicator, and display the System menu.

- Use [F1] to display the Tally MV Color sub menu.

Group1	Fixed to Red.
Group2	Fixed to Green.

- Use [F1] to display the Tally Target sub menu.

- Use [F2] to [F5] to select the material to allocate to Group1 to 4.

PGM	Program video signal
PVW	Preview video signal
CLN	Clean signal
ME PGM	ME program video signal
KeyOut	Key output signal
AUX1	AUX1 bus output signal
AUX2	AUX2 bus output signal
AUX3	AUX3 bus output signal
AUX4	AUX4 bus output signal

- Press the  button to light its indicator, and display the Multi View Display menu.

- Use [F1] to display the Tally Group 1 / 2 sub menu.

- Groups 1 and 2 set in ① to ④ above can be set to display on the multi view display.

Input/output signal settings

- ⑦ Use [F2] to [F4] to set the tally displays to overlay on the split frame of the multi view display.

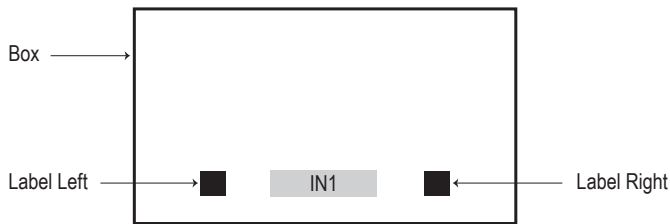

On	Tally displays are displayed.
Off	No tally displays are shown.

Changing the material names

The material names of the input signals (SDI IN1 to SDI IN8, IN-A1, IN-A2, IN-B1, IN-B2) to be set on the multi view display can be changed.

These names can be selected from the default settings or user settings.

- Press the button to light its indicator, and display the Input menu.
- Use [F1] to display the Input sub menu.
- Use [F2] to select the input to be set using the Select item.
Refer to "Input signal settings".
- Use [F1] to display the Name sub menu.



- Use [F2] to select the type of material names using the Type item.

Default (default settings)	The following material names are selected automatically. SDI IN1 to SDI IN8, IN-A1, IN-A2, IN-B1, IN-B2
User (user settings)	The material names are set using up to 32 characters.

User type setting procedure



- On the Name sub menu, use [F2] to select "User" using the Type item.
- Press [F3] to display the keyboard screen.
- Use [F1] to [F3], the positioner, the rotary encoders, and the number keys to enter a name, then press [F4].
To clear the name which has been input and close the keyboard screen, press [F5].
Refer to "Keyboard screen operations".

Setting the level meters

You can display at the top of each split screen the level meters for the embedded audio signals transmitted together with SDI/HDMI input and output.

Left display:

Channel 1 of group 1

Right display:

Channel 2 of group 1

- Press the button to light its indicator, and display the Multi View Display menu.

- Use [F1] to display the Display sub menu.

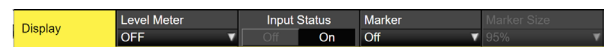

- Use [F2] to set the level meter display using the Level Meter item.

OFF	The level meters are not displayed.
IN ON	The level meters for the input signal, Clip, and color bar are displayed.
OUT ON	The level meters for PGM/PVW/ME PGM/CLN/AUX are displayed.
IN/OUT ON	The level meters for the input signal, Clip, color bar, and PGM/PVW/ME PGM/CLN/AUX are displayed.

Input/output signal settings

Setting the input signal marks

The status of the input signals can be displayed in front of the material names displayed on the split screens.

“F” mark:

This appears when the input signals are frozen.

“ ! ” mark:

This appears when no signals are input or when signals with different formats are input.

- When the “F” mark is displayed, the “!” mark is not displayed.

- ① On the Display sub menu, use [F3] to set the input signal status display using the Input Status item.

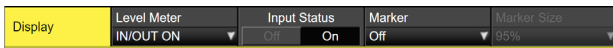

On	The input signal status is displayed.
Off	The input signal status is not displayed.

Setting the markers

Safety markers can be displayed for the multi view materials.

- ① On the Display sub menu, use [F4] to set the marker display using the Marker item.

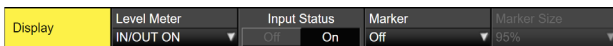

4:3	The markers are displayed using the 4:3 aspect ratio.
16:9	The markers are displayed using the 16:9 aspect ratio.
Off	The markers are not displayed.

- ② Use [F5] to set the size of the markers using the Marker Size item.

Input/output signal settings

Ancillary settings for the AUX bus, PGM, and PVW

Set the function that passes through the V ancillary data and embedded audio data of the SDI/HDMI input signal.

- Press the  button to light its indicator, and display the System menu.
- Use [F1] to display the Ancillary1 sub menu.



Setting for the output signals of the AUX buses (AUX1 to AUX4)

- Use [F2] to select "ON" or "OFF" using the AUX item.

OFF	The ancillary data and embedded audio of the AUX bus (AUX1 to 4) outputs are not passed through.
ON	The ancillary data and embedded audio of the AUX bus (AUX1 to 4) outputs are passed through.

Setting for the program output signals

- Use [F3] to select "ON" or "OFF" using the PGM item.

OFF	The ancillary data and embedded audio of the PGM/ME PGM outputs are not passed through.
ON	The ancillary data and embedded audio of the PGM/ME PGM outputs are passed through.

Setting for the preview output signals

- Use [F4] to select "ON" or "OFF" using the PVW item.

OFF	The ancillary data and embedded audio of the PVW outputs are not passed through.
ON	The ancillary data and embedded audio of the PVW outputs are passed through.

Setting for clean output signals

- Use [F5] to select "ON" or "OFF" using the CLN item.

OFF	The ancillary data and embedded audio of the CLN outputs are not passed through.
ON	The ancillary data and embedded audio of the CLN outputs are passed through.

Setting for the output signals of the multi view display

- Use [F1] to display the Ancillary2 sub menu.



- Use [F1] to select "PGM", "PVW" or "OFF" using the MV item.

PGM	The ancillary data and embedded audio of the PGM are passed through to all MV outputs.
PVW	The ancillary data and embedded audio of the PVW are passed through to all MV outputs.
OFF	The ancillary data and the embedded audio are not passed through any MV outputs.

Notes

- If Key and DSK are combined, the audio from them are also superimposed.
- When the AUX setting is ON, the DSK1 audio that is superimposed on AUX1 is simultaneously superimposed on AUX1 for output. Similarly, the DSK2 audio that is superimposed on AUX2 is simultaneously superimposed on AUX2 for output.
- VANC data is not passed if the format of the input signal is different to the system format.

Input/output signal settings

Audio settings for the AUX bus, PGM, and PVW

Select one item of SDI/HDMI input signal embedded audio data and make settings for the function for the passing through of each of the output signals.

For each output signal, you can select only 1 input signal from the following.

IN1, IN2	The embedded audio in SDI or HDMI input signals is passed through.
SDI IN3 to 8	The embedded audio in SDI input signals is passed through.
IN-A1 to 4	When option slot A is used, the embedded audio in SDI or HDMI input signals is passed through.
IN-B1 to 4	When option slot B is used, the embedded audio in SDI or HDMI input signals is passed through.
Follow Video	The embedded audio in input signals selected by a bus is passed through.
OFF	The embedded audio is not passed through.

The ancillary settings for each bus should be switched ON to enable this function.

① Press the  button to light its indicator, and display the System menu.

② Use [F1] to display the Audio1 sub menu.



Audio setting for the output signals of the AUX buses (AUX1 to AUX4)

③ Use [F2] to [F5] to set the input signals that will pass through embedded audio in the AUX1 to 4 items.

Audio setting for the program output signals

④ Use [F1] to display the Audio2 sub menu.



⑤ Use [F2] to set the input signals that will pass through embedded audio in the PGM item.

Audio setting for the preview output signals

⑥ Use [F3] to set the input signals that will pass through embedded audio in the PVW item.

Audio setting for clean output signals

⑦ Use [F4] to set the input signals that will pass through embedded audio in the CLN item.

Audio setting for the output signals of the multi view display

⑧ Use [F5] to set the input signals that will pass through embedded audio in the MV item.

System settings

Setting the system format

One system format (input/output signal) can be selected.

Do not change the format during any of the following operations:

- When reading from a memory card or saving to a memory card
- When restoring data from video memory or saving data to internal storage
- When recording moving images or still images
- When moving images are playing

① Press the  button to light its indicator, and display the System menu.

② Use [F1] to display the Format sub menu.

Format	Format	Switcher Mode	Color Space
	2160/59.94p	▼ 4K	▼ SDR BT.709

③ Use [F2], select the format using the Format item, and press the [F2] to enter the selection.

Switcher mode settings

① From the Format sub menu, use [F3] to select either 2K or 4K in the Switcher item, then press [F3] to confirm the selection.

- When the Switcher mode is changed from either 2K to 4K or from 4K to 2K, a dialog is displayed, so press [F1] to restart the unit. The menu values are initialized after restart.

Dynamic range and color range settings

① From the Format sub menu, use [F4] to select the dynamic range and color range of the image signals handled by this unit in the Color Space item, then press [F4] to confirm the selection.

HDR BT.2020	The dynamic range is HDR and color range operates as BT.2020.
HDR BT.709	The dynamic range is HDR and color range operates as BT.709.
SDR BT.709	The dynamic range is SDR and color range operates as BT.709.

System settings

Setting the crosspoints

Assigning signals to the crosspoints

External video input signals and internally generated signals can be assigned to crosspoint buttons 1 to 24. When one of the crosspoint buttons 1 to 24 is held down, the status of the signal assigned is displayed on the built-in display while the button is held down.

Changing the current assignment of the signals selected by the crosspoint buttons will cause the positions of the lit crosspoint buttons to change to correspond with the assignment change. The images output at this time will remain unchanged.

The table below lists the materials which can be assigned.

Signal	What appears on the display	Description
IN1, IN2	IN1, IN2	SDI/HDMI input 1, 2
SDI IN3 to SDI IN8	SDI IN3 to SDI IN8	SDI input 3 to 8
IN-A1 to 4, IN-B1 to 4	IN-A1 to 4, IN-B1 to 4	Option slot (SDI, HDMI)
Black	BLK	Internally generated signal (black)
CBGD1, CBGD2	CBGD1, CBGD2	Internally generated signal (color background)
CBAR	CBAR	Internally generated signal (color bar)
Still1V, Still1K, Still2V, Still2K	Still1V, Still1K, Still2V, Still2K	Still image video memory
Clip1V, Clip1K, Clip2V, Clip2K	Clip1V, Clip1K, Clip2V, Clip2K	Moving image video memory
CLN	CLN	CLN (AUX bus and built-in display images only)
KeyOut	KeyOut	KeyOut (AUX bus and built-in display images only)
ME PGM	ME PGM	ME PGM (AUX bus and built-in display images only)
Shift	SHIFT	SHIFT function
None	None	No assignment

- The image will not be changed by pressing any button to which "None" is assigned.

The table below lists the default settings.

Button	What appears on the display	Button	What appears on the display	Button	What appears on the display
XPT1	IN1	XPT9	CBAR	XPT17	None
XPT2	IN2	XPT10	CBGD1	XPT18	None
XPT3	SDI IN 3	XPT11	CBGD2	XPT19	None
XPT4	SDI IN 4	XPT12	None	XPT20	None
XPT5	SDI IN 5	XPT13	None	XPT21	None
XPT6	SDI IN 6	XPT14	None	XPT22	None
XPT7	SDI IN 7	XPT15	None	XPT23	None
XPT8	SDI IN 8	XPT16	None	XPT24	None

System settings

Setting the crosspoint switching

The timing at which the crosspoints are to be switched can be set.

This switching involves the operations of the crosspoint buttons and [Cut] button.

- ① Press the  button to light its indicator, and display the XPT menu.
- ② Use [F1] to display the XPT Switch sub menu.



- ③ Use [F2], and select the switching timing using the Timing item.

Any	The crosspoints are switched in the nearest field. This is suited to live applications.
Field1	The crosspoints are switched in field 1. This is suited to editing applications.
Field2	The crosspoints are switched in field 2. This is suited to editing applications.

System settings

Button assignments

Setting the user buttons

The user can assign several functions which can be set using the menu items into eight user buttons (U1 to U8). The user buttons light in amber when the assigned function is ON and are off when the assigned function is OFF. Each time the user button is pressed, the function setting alternates between ON and OFF.

The table below lists the functions which can be assigned to the user buttons (U1 to U8).

Function name	Description of function
KEY1 PVW	Output the KEY1 image to the preview output.
KEY2 PVW	Output the KEY2 image to the preview output.
KEY3 PVW	Output the KEY3 image to the preview output.
DSK1 PVW	Output the DSK1 image to the preview output.
DSK2 PVW	Output the DSK2 image to the preview output.
GPII-EN	Enables or disables GPI-In.
GPIO-EN	Enables or disables GPI-Out.
SHIFT	Switches all the A/B bus and AUX bus crosspoints between front and rear.
AUX TRANS	Enables or disables the AUX bus transitions.
AUX1 TRANS	Enables or disables the AUX1 bus transitions.
AUX2 TRANS	Enables or disables the AUX2 bus transitions.
DSK1 on AUX1	Adds DSK to the AUX1 output.
DSK2 on AUX2	Adds DSK to the AUX2 output.
Effect Dissolve	Switches effect dissolve between ON and OFF.
Macro Attach	Switches macro attach between ON and OFF.
Dissolve	Nothing is assigned.

Default settings

Button	Function name	Button	Function name
U1	KEY1 PVW	U5	DSK2 PVW
U2	KEY2 PVW	U6	AUX Trans
U3	KEY3 PVW	U7	Effect Dissolve
U4	DSK1 PVW	U8	SHIFT

<Setting method>

- Press the  button to light its indicator, and display the Config menu.
- Use [F1] to display the User Button1 sub menu and User Button2 sub menu.

• User Button1 to 4 sub menu



- Use [F2] to select the function to be assigned to the [U1] button using the User1 item.
- Use [F3] to select the function to be assigned to the [U2] button using the User2 item.
- Use [F4] to select the function to be assigned to the [U3] button using the User3 item.
- Use [F5] to select the function to be assigned to the [U4] button using the User4 item.

• User Button5 to 8 sub menu



- Use [F2] to select the function to be assigned to the [U5] button using the User5 item.
- Use [F3] to select the function to be assigned to the [U6] button using the User6 item.
- Use [F4] to select the function to be assigned to the [U7] button using the User7 item.
- Use [F5] to select the function to be assigned to the [U8] button using the User8 item.

System settings

Setting the date and time

The user can set the date and time to be used as the memory card's time stamp.

Be absolutely sure to set them when a memory card is to be used.

Setting the date

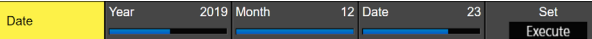
- 1 Press the  button to light its indicator, and display the System menu.
 - 2 Use [F1] to display the Date sub menu.
- 
- 3 Use [F2] to set the year using the Year item.
 - 4 Use [F3] to set the month using the Month item.
 - 5 Use [F4] to set the day using the Date item.
 - 6 Press the [F5] to enter the year/month/day.

Setting the time

- 1 On the System menu, use [F1] to display the Time sub menu.

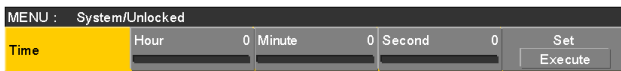

- 2 Use [F2] to set the hour using the Hour item.
- 3 Use [F3] to set the minutes using the Minute item.
- 4 Use [F4] to set the seconds using the Second item.
- 5 Press the [F5] to enter the hour/minutes/seconds.

Loading the date and time

- 1 On the System menu, use [F1] to display the Now sub menu.



- 2 Press [F2] to load the date currently set.
- 3 Press [F3] to load the current time.

Network settings



Proceed with the network settings to perform such tasks as updating the software version via LAN.

The network initial setup is: IP address: 192.168.0.8, subnet mask: 255.255.255.0.

When using the host computer with settings matching the initial setup, it is not necessary to setup via the menu.

For the setting to take effect, the system must be rebooted. Turn the system's power off and then back on.

Entering the IP address

- 1 Press the  button to light its indicator, and display the System menu.
 - 2 Use [F1] to display the Network1 sub menu.
- 
- 3 Use [F2] to [F5] to input the IP address, and press the [F5] (Save) to enter the address.

Entering the subnet mask

- 1 On the System menu, use [F1] to display the Network2 sub menu.
- 
- 2 Use [F2] to [F5] to input the subnet mask, and press the [F5] (Save) to enter the mask.

Setting the gateway

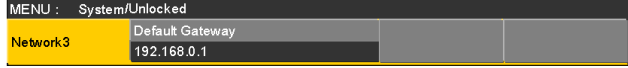
- 1 On the System menu, use [F1] to display the Network3 sub menu.
- 
- 2 Use [F2] to [F5] to set the gateway, and then press [F5] (Save) to enter the setting.
 - This will be blank if it is not set.

Display the MAC address

- 1 On the System menu, use [F1] to display the Network4 sub menu.

The MAC address now appears.

System settings

Setting the built-in display backlight and button illumination

Setting the built-in display backlight

The built-in display backlight can be set to ON or OFF. It is also possible to automatically turn off the built-in display backlight when no control panel operation is performed within a set time interval.

- ① Press the  button to light its indicator, and display the Config menu.
- ② Use [F1] to display the LCD Backlight sub menu.



- ③ Use [F2] to select the setting for the backlight using the Light item.

On	Backlight is turned on all the time.
Off	The backlight turns off as soon as "Off" is selected as the setting. It lights up when the control panel is operated. (The "On" status is selected as the setting.)
60, 120, 180	When no control panel operation is performed within a set time interval (60 minutes, 120 minutes, 180 minutes), the built-in display backlight is turned off automatically. Even when the set time interval elapses and the display backlight is turned off, the backlight comes back on when a control panel operation is performed.

- ④ Use [F3] to set the brightness of the backlight using the Adjust item.

Setting the button illumination

The button indicators in the areas listed below can be kept illuminated all the time.

It is then easier to read the characters displayed on the buttons even when the unit is operated in dark places.

- Memory/wipe pattern/number key area
- User button area
- Display area
- Crosspoint area
- Transition area

- ① Press the  button to light its indicator, and display the Config menu.
- ② Use [F1] to display the Button Illumination sub menu.



- ③ Use [F2] to make settings for the memory/wipe pattern/number key area, the user button area, and the display area in the Dimmer item.

Off	The button illumination does not light.
80% to 150%	The button illumination lights. Brightness can be adjusted between 80% and 150%.

- ④ Use [F3] to make settings for the button selected in the Lighting item.

80% to 150%	The button illumination lights. Brightness can be adjusted between 80% and 150%.
--------------------	----------------------------------------------------------------------------------

- ⑤ Use [F4] to make settings for the button when off in the XPT Color item.

Input	Make the button illumination light white.
Color Group1 to 8	8 different colors can be set.

- ⑥ Use [F5] to make settings for the button when off in the Transition Color item.

Input	Make the button illumination light white.
Color Group1 to 8	8 different colors can be set.

- ⑦ Use [F1] to display the Button Color Group1 sub menu.



- ⑧ Use [F2] to [F4] to set the [R], [G], and [B] for button illumination.

System settings

Status displays

Alarm status displays

The alert status (alarms) for this unit's power supply and cooling fan are displayed on the built-in display.

- ① Press the  button to light its indicator, and display the System menu.
- ② Use [F1] to display the Alarm sub menu.

MENU : System/Unlocked			
Alarm	Power No Alarm	Fan No Alarm	Temperature No Alarm

The alert status of the power supplies is displayed in the Power item.

The alert status of the cooling fan is displayed in the Fan item.

The alert status of the internal temperature is displayed in the Temperature item.

No Alarm	No irregularity
Alarm	Irregularity

Alarm message

A message is displayed on the built-in display when an alarm has occurred.

Alarm message displayed	Type of trouble	Operation
ALARM ! Fan Stop	Shutdown of the cooling fan	When OK is pressed, the alarm message is cleared. • Contact your dealer immediately.
ALARM ! Power Failure	Drop in the supply voltage	
ALARM ! Temperature	Rise in the temperature inside the unit	

System settings

Displaying information about the version and optional units

Display information about the versions of software and hardware in the unit and the versions of the optional units that are connected.

Displaying the version information

- ① Press the  button to light its indicator, and display the System menu.
- ② Use [F1] to display the System Version sub menu.

System Version	System Version AV-UHS500_v1_02	Set Execute	Delete Execute
----------------	-----------------------------------	----------------	-------------------

- The unit's system version information is displayed in the System Version item.

Displaying information for optional units

- ③ Use [F1] to display the Option sub menu.

Option	Slot A SDI-IN	Slot B 4K-DVE		
--------	------------------	------------------	--	--

- ④ Use [F2] to select the option slot using the Select item.

SLOT A	Option slot A
SLOT B	Option slot B

- ⑤ The types of the optional units connected are displayed in the Slot A/Slot B item.
 - "None" is displayed when there is no connection.

System settings

Initialization

Initializing setting data

Initialization returns the set data to the factory shipment status.

When settings data is initialized, video memory that has been saved to internal storage is lost.

<Items and data which are not initialized>

- The items of the System menu listed below:
Network1, Network2, Network3, Date, Time

① Press the  button to light its indicator and display the System menu.

② Use [F1] to display the Initial sub menu.

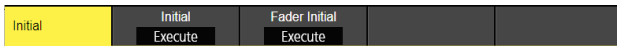

③ Press [F2] to proceed with the initializing.

④ When initializing, use [F1] to select “Yes” and press the [F1].
When not initializing, use [F5] to select “No” and press the [F5].

Initializing fader

The range for executing a transition can be initialized by operating the fader lever.

Initialization should be performed when transitions are not completed to the end even when the fader lever has been moved as far as it will go.

① Press [F3] in the Initial sub menu to perform initialization.

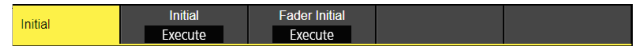

② When initializing, use [F1] to select “Yes” and press the [F1].
When not initializing, use [F5] to select “No” and press the [F5].

Remote camera link functions

It is possible to connect a maximum of 16 remote cameras to this unit via LAN and remote control them. The remote cameras that can be connected are as follows (as of October 2020):

- AW-UE150 series
- AW-HR140 series
- AW-HE130 series
- AW-UE100 series
- AW-HN130 series
- AW-UE70 series
- AW-UN70 series
- AW-HE40 series
- AW-HN40 series
- AW-HE42 series

Refer to the following Web site for details.
<https://pro-av.panasonic.net/>

Examples of connections

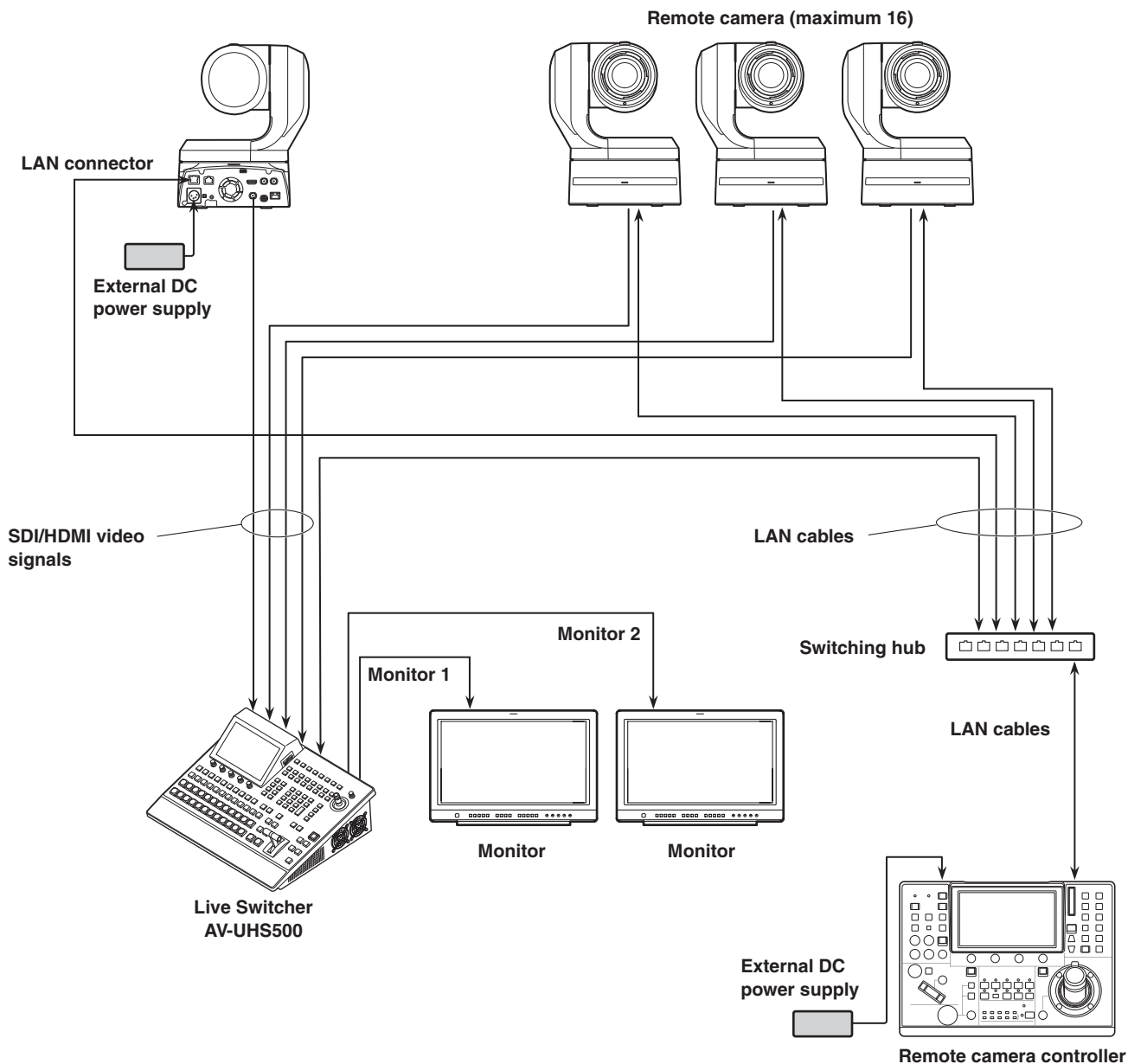

- Use a GbE compatible switching hub and Cat5e or better STP LAN cables for the connection between the unit and the remote cameras.
- Furthermore, use a network design so that the IP addresses for the unit and the remote cameras are within the same subnet.

Remote camera link functions

The control functions for the remote cameras connected to this unit are as follows:

- IP address automatic detection
- A maximum of 100 preset memories can be played back and registered
- Pan and tilt of each connected remote camera can be controlled with the positioner on this unit
- Zoom of each connected remote camera can be controlled with the encoders on this unit
- Focus and iris of each connected remote camera can be controlled with the encoders on this unit
- Control of pan, tilt, zoom, focus, and iris can be individually disabled
- Images of remote cameras connected to this unit can be adjusted
White balance/AWB/ABB/Gain/R Gain/B Gain/Pedestal
- On-screen menus of remote cameras connected to this unit can be displayed and operated
- The remote cameras connected to this unit can be switched between ON and standby as a group or individually
- It is possible to tally control connected remote cameras linked to the tally status of this unit
- Errors on remote cameras connected to this unit can be detected

Settings for connections to remote cameras

Selecting the terminals for remote camera connection

- ① Press the  button to light its indicator and display the Input menu.
- ② Use [F1] to display the Input sub menu.



- ③ Press [F2] and select the input signal to which the remote camera is connected in the Select item.
- The following remote camera settings are possible according to the input to IN1 and 2, SDI IN 3 to 8, IN-A1 to 4, and IN-B1 to 4.

IP address settings

To set automatically

You can scan for the IP addresses set in the connected remote cameras and set them in this unit.

- ① Use [F1] to display the Camera Settings1 sub menu.



- ② Use [F5] to execute the Scan IP Address item to scan for the IP addresses of connected remote cameras.
- The scan results are displayed in the list of the IP address item.
 - When "Select From List" is displayed, use [F2] and select the IP address of the connected remote camera in the IP address item.

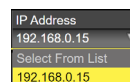

- "Not Detected" is displayed if the IP address of the remote camera could not be detected.
- Modify the IP address of the unit or the remote camera and set so that there is no duplication.
- The "Duplicate IP Address Detected. (ErrNo = - 650)" error message is displayed if the IP address of the remote camera is duplicated.

Remote camera link functions

To set manually

You can directly set the IP addresses set in the connected remote cameras in this unit.

- ① Use [F1] to display the Camera Settings1 sub menu.

Camera Settings1	IP Address	Port	80	Edit IP Address	Scan IP Address
	192.168.0.15			Execute	Execute

- ② Use [F4] to execute the Edit IP Address item, then enter the IP addresses of connected remote cameras.

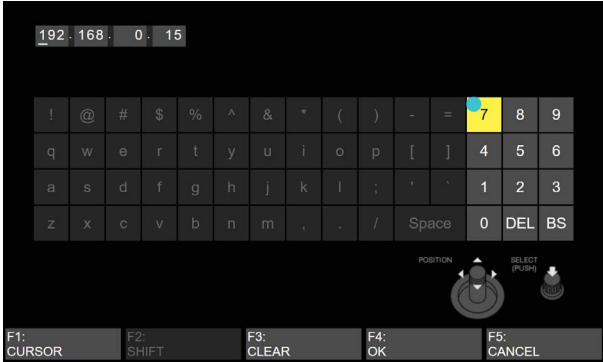

Remote camera port settings

- ③ From the Camera Settings1 sub menu, use [F3] to set the port to which the remote camera is connected in the Port item.

Remote camera authentication settings

- ① Use [F1] to display the Camera Settings2 sub menu.

Camera Settings2	Edit User Name	Edit Password	Name	Network Status
	Execute	Execute	UE150_BaseCamp	Connected

- ② Use [F2] to execute the Edit User Name item and set the user name used for authentication with the remote camera.

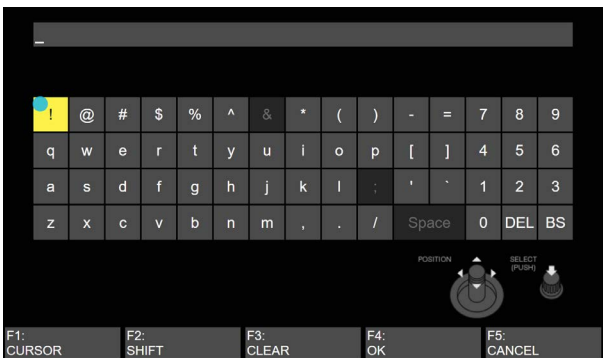

- ③ Use [F3] to execute the Edit Password item, then set the password used for authentication with the remote camera.

Checking the remote camera connection status

- ① Use [F1] to display the Camera Settings2 sub menu.

Camera Settings2	Edit User Name	Edit Password	Name	Network Status
	Execute	Execute	UE150_BaseCamp	Connected

- ② The camera name set on the remote camera is displayed in the Name item.
- ③ The IP connection status of the unit and the remote cameras is displayed in the Network Status item.

No IP Address	The IP address of the camera has not been entered in the Input menu.
Now Checking...	The unit and the remote camera are communicating.
Connected	The unit and the remote camera are connected.
Unauthorized	Authentication information has not been entered or is incorrect.
Not Connected	There is a communication error.

Remote camera link functions

Remote camera operation direction settings

You can use the positioner and encoders of this unit to control the pan, tilt, zoom, focus, and iris of remote cameras connected to this unit.

The settings for the operation direction are made as follows:

- Use [F1] to display the Camera Settings3 sub menu.

Camera Settings3	Pan Direction Normal Reverse	Tilt Direction Normal Reverse	Tally (Group1) Disable Enable
------------------	---------------------------------	----------------------------------	----------------------------------

- The pan control direction for the remote camera using the positioner of this unit is set in the Pan Direction item.

Normal	The operation direction of the positioner and the direction of image movement are the same.
Reverse	The operation direction of the positioner and the direction of image movement are the opposite.

- The tilt control direction for the remote camera using the positioner of this unit is set in the Tilt Direction item.

Normal	The operation direction of the positioner and the direction of image movement are the same.
Reverse	The operation direction of the positioner and the direction of image movement are the opposite.

- Use [F1] to display the Camera Settings4 sub menu.

Camera Settings4	Zoom Direction Normal Reverse	Focus Direction Normal Reverse	Iris Direction Normal Reverse
------------------	----------------------------------	-----------------------------------	----------------------------------

- The zoom control direction for the remote camera using [F1]/[F2]/[F3]/[Z] operations of this unit is set in the Zoom Direction item.

Normal	Zoom moves to the telephoto end when [F1] is pressed. Zoom moves to the wide end when [F2] is pressed. Zoom moves to the telephoto end when [F3]/[Z] is turned clockwise. Zoom moves to the wide end when [F3]/[Z] is turned counterclockwise.
Reverse	Zoom moves to the wide end when [F1] is pressed. Zoom moves to the telephoto end when [F2] is pressed. Zoom moves to the wide end when [F3]/[Z] is turned clockwise. Zoom moves to the telephoto end when [F3]/[Z] is turned counterclockwise.

- The focus control direction for the remote camera using [F4] operations of this unit is set in the Focus Direction item.

Normal	Focus moves to the far side with a clockwise turn. Focus moves to the near side with a counterclockwise turn.
Reverse	Focus moves to the near side with a clockwise turn. Focus moves to the far side with a counterclockwise turn.

- The iris control direction for the remote camera using [F5] operations of this unit is set in the Iris Direction item.

Normal	The iris opens with a clockwise turn. The iris closes with a counterclockwise turn.
Reverse	The iris closes with a clockwise turn. The iris opens with a counterclockwise turn.

Remote camera tally control settings

You can link the red tally control of remote cameras connected to this unit to the red tally control of this unit.

- Use [F1] to display the Camera Settings3 sub menu.

Camera Settings3	Pan Direction Normal Reverse	Tilt Direction Normal Reverse	Tally (Group1) Disable Enable
------------------	---------------------------------	----------------------------------	----------------------------------

- Set the link between the red tally control on this unit and the red tally control on the remote camera in the Tally (Group1) item.

Enable	Linked.
Disable	Not linked.

Remote camera link functions

Selecting the cameras to be operated

By connecting remote cameras to this unit, you can control remote cameras using the positioner and encoders of this unit.

- Assign the remote cameras connected to XPT. Refer to "Selecting the terminals for remote camera connection" for information on how to assign.
- Press the [DISP/CAM] button to make it turn green.

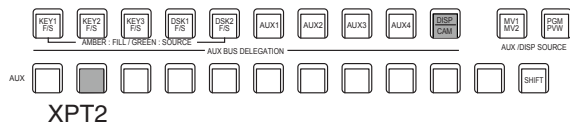

- Select the remote cameras assigned in Step ① as the CAM bus sources.
 - The selected buses turn green.

The inputs that can be selected as the CAM bus sources are the following inputs. XPTs other than these cannot be selected.

- IN1 to IN2
- SDI IN3 to SDI IN8
- IN-A1 to IN-A4
- IN-B1 to IN-B4

- Control of remote cameras is available only when either the [CAM PMEM] screen or [CAM CONT] screen is being displayed.

- The pan and tilt on the remote camera connected to this unit are controlled by moving the positioner up, down, left, and right.

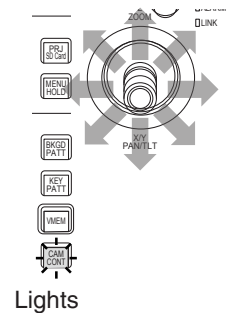

- Turning [Z] left and right adjusts the control speed for pan/tilt and operates the zoom.

You can switch the control speed and zoom operation by pressing [Z].

Remote camera link functions

Controlling in the camera control screen

When remote cameras are connected to this unit, you can control them in the camera control screen while displaying the input images from the selected camera on the built-in LCD.

- ① While the unit is connected to the remote camera, press the  button.
- ② The display on the built-in display of this unit changes, and the [CAM CONT] button turns amber.

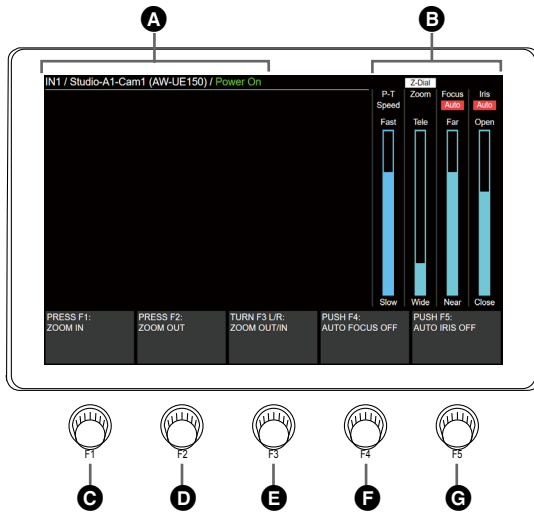

A	Input source information display	The following information is displayed: The CAM bus source material name/camera name/(camera model name)/camera status The name set on the remote camera is displayed as the camera name.
	Camera status	
	Power On	Normal situation
	Pan & Tilt Alarm	When a problem is detected with the pan/tilt of the camera
	Fan Alarm	When a problem is detected with the fan of the camera
	Other Alarm	When a problem is detected with something other than the pan/tilt or fan of the camera
	Camera IP Connection Error	When the camera failed to connect via IP
	No IP Address for Camera	When the IP address has not been set for the camera corresponding to the input signal
	Now Connecting to Camera...	When connecting to the camera for the first time after switching the input signal
Standby	When the camera is on standby	
B	Z-Dial	Indicates the application for [Z]. Each time you press [Z], operation switches between P-T Speed and Zoom.
	P-T Speed	Indicates the status of the control speed of pan/tilt. "Fast" indicates fast operation and "Slow" indicates slow operation.
	Zoom	Indicates the zoom position. "Tele" indicates the telephoto side and "Wide" indicates the wide side.
	Focus	Indicates the focus position. "Far" indicates the far side and "Near" indicates the near side. "Auto" is displayed when auto focus is on.
	Iris	Indicates the iris status. "Open" indicates that the iris is open and "Close" indicates that the iris is closed. "Auto" is displayed when the auto iris is on.
C	[F1]	Zoom moves to the telephoto end at a constant speed when the button is pressed. An explanation is also displayed on the Menu screen.
D	[F2]	Zoom moves to the wide end at a constant speed when the button is pressed. An explanation is also displayed on the Menu screen.
E	[F3]	Turn left and right to operate the zoom. Zoom to the wide end with a counterclockwise turn and to the telephoto end with a clockwise turn. An explanation is also displayed on the Menu screen.
F	[F4]	Turn left and right to operate the focus. Focus moves to the near side with a counterclockwise turn and to the far side with a clockwise turn. Focus switches between auto and manual when the button is pressed. An explanation is also displayed on the Menu screen.
G	[F5]	Turn left and right to operate the iris. The iris closes with a counterclockwise turn and the iris opens with a clockwise turn. Iris switches between auto and manual when the button is pressed. An explanation is also displayed on the Menu screen.

- If control of the remote cameras is disabled, explanations for F1 to F5 are not displayed.

Remote camera link functions

Remote camera settings

When the unit is connected to the remote camera, you can make settings on the camera from this unit.

Selecting the remote camera, checking information, and controlling power

- ① Press the  button to display the Camera menu.
- ② Use [F1] to display the Camera Information sub menu.

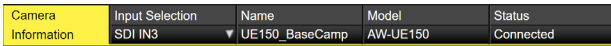

- ③ Use [F2] to select the input source of the remote camera you want to set in Input Selection.

You can check the following information.

Name	The name of the remote camera connected to the unit is displayed. The name set on the remote camera is displayed.	
Model	The model names of the remote cameras connected to the unit are displayed.	
Status	The IP connection status of the unit and the remote cameras is displayed.	
	No IP Address	The IP address of the camera has not been entered in the Input menu
	Now Checking...	The unit and the remote camera are communicating and are not yet finished
	Connected	The unit and the remote camera are communicating normally
	Unauthorized	Authentication information for the unit and the remote camera has not been entered or is incorrect
	Not Connected	There is a communication error between the unit and the remote camera
	Please Wait...	Remote camera currently switching between power ON and standby
	Pan & Tilt Alarm	A problem has been detected with the pan/tilt of the remote camera
	Fan Alarm	A problem has been detected with the fan of the remote camera
	Other Alarm	A problem has been detected with something other than the pan/tilt or fan of the remote camera

- ④ Use [F1] to display the Camera Control sub menu.



- ⑤ Use [F2] and switch between power ON and standby for the remote camera corresponding to the input signal selected in the Power item.
- ⑥ Use [F3] to turn ON all of the remote cameras connected to this unit in the All Power On item.
- ⑦ Use [F4] to set to standby all of the remote cameras connected to this unit in the All Standby item.
- ⑧ Use [F5] to switch the use for [Z] in the Z-Dial Usage item.

P-T Sp. & Zoom	Either adjust the control speed for pan/tilt or set the zoom control. Press and you can switch the control speed and zoom control.
P-T Speed Only	Set only the pan/tilt control speed adjustments.

Remote camera link functions

Remote camera control speed settings

You can set the pan/tilt control, zoom control speed, focus control speed, and iris control speed for remote cameras connected to this unit.

The adjustments can be made in 32 steps, with the control speed increasing the higher the number.

① Press the  button to display the Camera menu.

② Use [F1] to display the Control Speed sub menu.



③ Use [F2] to set the pan/tilt control speed in the Pan & Tilt item.

④ Use [F3] to set the zoom control speed in the Zoom item.

⑤ Use [F4] to set the focus control speed in the Focus item.

⑥ Use [F5] to set the iris control speed in the Iris item.

Remote camera on-screen menu and color bar settings

① Press the  button to display the Camera menu.

② Use [F1] to display the OSD Menu & Color Bars sub menu.



③ Use [F2] to set the display of the on-screen menu of the remote camera in the OSD Menu item.

On	Displayed.
Off	Not displayed.

④ You can use [F3] to operate the on-screen menus of the remote camera in the Menu Operation item.

Counterclockwise turn	Moves the cursor up.
Clockwise turn	Moves the cursor down.
Press	Confirmed.

⑤ Use [F4] to set the output images from the remote camera in the color bar in the Color Bars item.

On	The color bar is set. Set the type of color bar on the camera.
Off	Normal image is set.

Remote camera link functions

Remote camera lens control settings

- Press the  button to display the Camera menu.
- Use [F1] to display the Lens Control sub menu.

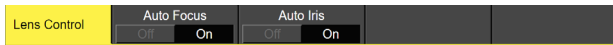

- Use [F2] to set the auto focus of the remote camera in the Auto Focus item.

On	Auto Focus
Off	Manual Focus

- Use [F3] to set the auto iris of the remote camera in the Auto Iris item.

On	Auto Iris
Off	Manual Iris

- The operation explanation on the camera control screen is as follows.



When Auto Focus/Auto Iris is "Off":

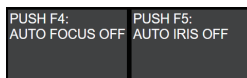

When Auto Focus/Auto Iris is "On":

Remote camera image adjustment settings

- Press the  button to display the Camera menu.
- Use [F1] to display the AWB sub menu.



- Use [F4] to set the automatic white balance adjustment mode in the AWB Mode item.
- Use [F2] to execute the automatic white balance adjustments.
- The result of the adjustment is displayed in the Last AWB Result item.

Successful	Successful.
Failed	Failed.
—	When this unit is starting up or the input signal has been changed

- Use [F1] to display the ABB sub menu.



- Use [F2] to execute the automatic black balance adjustments.
- The result of the adjustment is displayed in the Last ABB Result item.

Successful	Successful.
Failed	Failed.
—	When this unit is starting up or the input signal has been changed

- Use [F1] to display the Gain1/Gain2/Pedestal sub menus.

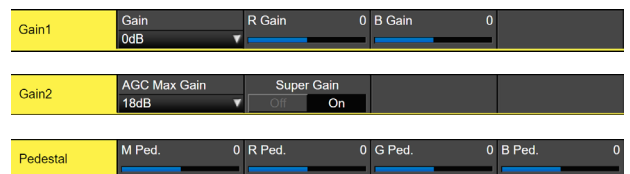

- Use [F2] to [F5] to set each of the items.
 - Refer to the operating instructions for the connected remote camera for details about the setting values.

Remote camera link functions

Remote camera preset memory playback settings

- Press the  button to display the Camera menu.
- Use [F1] to display the Preset Settings sub menu.



- Use [F2] to [F5] to set each of the items.
 - Refer to the operating instructions for the connected remote camera for details about the setting values.

Disabling remote camera control

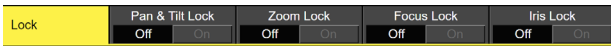

You can individually disable the control of the pan/tilt, zoom, focus, and iris for remote cameras connected to this unit.

- Press the  button to display the Camera menu.
- Use [F1] to display the Lock sub menu.





- Use [F2] to set the pan/tilt control and speed adjustment control enable/disable of the remote camera in the Pan & Tilt Lock item.

On	Disable
Off	Enable

- When Lock is engaged and you press either the  button or the  button, “” is displayed above “P-T Speed” at the right of the built-in display.

- Use [F3] to set the zoom control and speed adjustment control enable/disable of the remote camera in the Zoom Lock item.

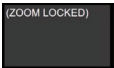

On	Disable
Off	Enable

- When Lock is engaged and you press either the  button or the  button, “” is displayed above “Zoom” at the right of the built-in display.
- The [F1]/[F2] operation descriptions will be blank.
- “ZOOM LOCKED” is displayed in the [F3] operation description.



- Use [F4] to set the focus control and speed adjustment control enable/disable of the remote camera in the Focus Lock item.

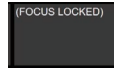

On	Disable
Off	Enable

- When Lock is engaged and you press either the  button or the  button, “” is displayed above “Focus” at the right of the built-in display.
- “FOCUS LOCKED” is displayed in the [F4] operation description.



- Use [F5] to set the iris control and speed adjustment control enable/disable of the remote camera in the Iris Lock item.

On	Disable
Off	Enable

- When Lock is engaged and you press either the  button or the  button, “” is displayed above “Iris” at the right of the built-in display.
- “IRIS LOCKED” is displayed in the [F5] operation description.

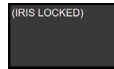

Remote camera link functions

Controlling in the camera preset memory screen

When remote cameras are connected to this unit, you can control them in the camera preset screen while displaying the thumbnail image of the selected camera preset memory on the built-in LCD.

- ① Press the  button.
- ② The display on the built-in LCD of the unit switches.
 - It is possible to save, play back, and delete preset memories using the number keys.
 - Zoom control is possible using [F1] to [F3].
 - It is possible to change the preset scope/preset speed using [F4]/[F5].

You can store up to a maximum of 100 preset memories in the remote cameras connected to this unit.

- They are not stored in this unit.

100 preset memories are divided between 10 pages, so 10 preset memories can be saved in 1 page.

If there is a preset memory that corresponds to the number key, the LED of the number key lights.

The number key that corresponds to the preset memory that was recalled last on this unit turns amber and all others turn green.

You can select the operation for the preset memory each time you press the [STORE]/[RECALL]/[DEL] buttons.

- While the [STORE] button is lit red, you can store preset memories by holding down the number keys.
- While the [RECALL] button is lit amber, you can execute preset memories by pressing the number keys.
- While the [DEL] button is lit red, you can delete preset memories by holding down the number keys.

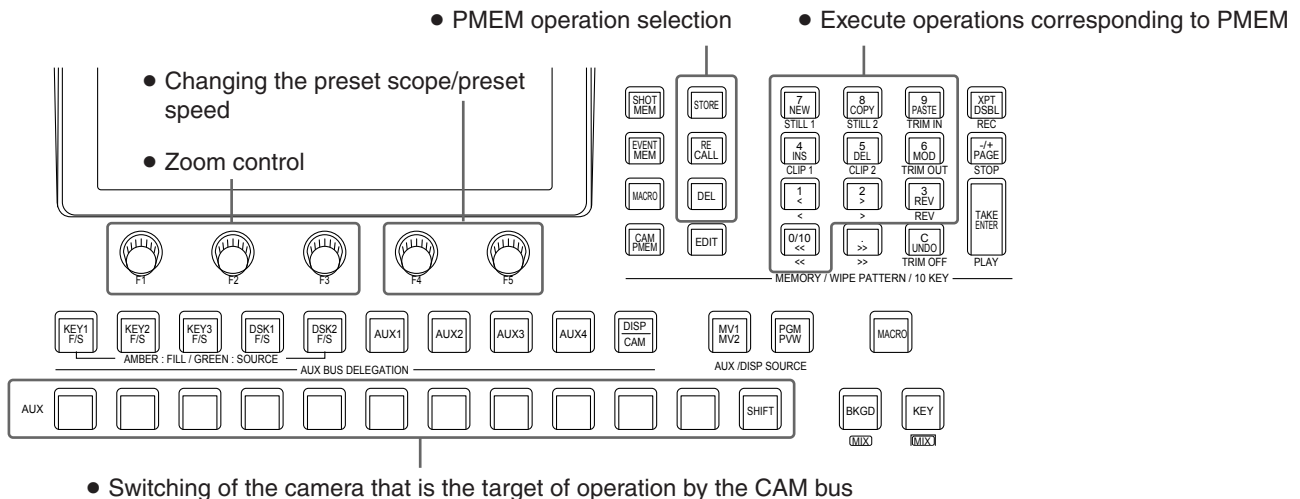

- Switching of the camera that is the target of operation by the CAM bus

Remote camera link functions



A	Input source information display	The following information is displayed. The CAM bus source material name/camera name/(camera model name)/camera status The name set on the remote camera is displayed as the camera name.
	Camera status	
	Power On	Normal situation
	Pan & Tilt Alarm	When a problem is detected with the pan/tilt of the camera
	Fan Alarm	When a problem is detected with the fan of the camera
	Other Alarm	When a problem is detected with something other than the pan/tilt or fan of the camera
	Camera IP Connection Error	When the camera failed to connect via IP
	No IP Address for Camera	When the IP address has not been set for the camera corresponding to the input signal
Now Connecting to Camera...	When connecting to the camera for the first time after switching the input signal	
Standby	When the camera is on standby	
B	Z-Dial	Indicates the application for [Z]. Each time you press [Z], operation switches between P-T Speed and Zoom.
	P-T Speed	Indicates the status of the control speed of pan/tilt. "Fast" indicates fast operation and "Slow" indicates slow operation.
	Zoom	Indicates the zoom position. "Tele" indicates the telephoto side and "Wide" indicates the wide side.
	Focus	Indicates the focus position. "Far" indicates the far side and "Near" indicates the near side. "Auto" is displayed when auto focus is on.
	Iris	Indicates the iris status. "Open" indicates that the iris is open and "Close" indicates that the iris is closed. "Auto" is displayed when the auto iris is on.
C	[F1]	Zoom moves to the telephoto end at a constant speed when the button is pressed.
	[F2]	Zoom moves to the wide end at a constant speed when the button is pressed.
	[F3]	Turn left and right to operate the zoom. Zoom to the wide end with a counterclockwise turn and to the telephoto end with a clockwise turn.
	[F4]	Turn left and right to operate the preset targets. Preset targets can be switched between the following 3 modes.
F	Mode A	Set the pan/tilt, zoom, focus, iris, gain, and white balance that are the targets of presetting.
	Mode B	Set the pan/tilt, zoom, focus, and iris that are the targets of presetting.
	Mode C	Set the pan/tilt, zoom, and focus that are the targets of presetting.
G	[F5]	
	1	Minimum speed (When set to the pan/tilt operating time: 99)
	20	Default value (When set to the pan/tilt operating time: 20)
	30	Maximum speed (When set to the pan/tilt operating time: 1)

- The screen displays here show the models that support thumbnails (AW-UE150/AW-UE100 series). Other models will not display thumbnails, with icons displayed instead.
- It is not possible to set the pan/tilt operating time for all of the remote cameras. Refer to the user guide for the remote camera for details.

Remote camera link functions

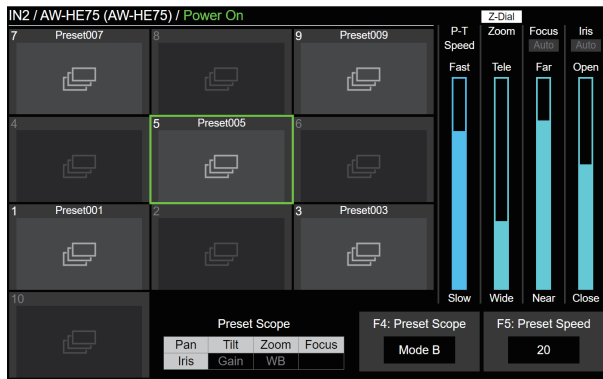

- If control of the remote cameras is disabled, explanations for F4 and F5 are not displayed.

Storing preset memories

- ① Operate the **[CAM PMEM]** button to make it turn amber.
- ② Operate the **[STORE]** button to make it turn red.
- ③ Hold down the number key that corresponds to the preset memory to be stored to store.
 - After storing is complete, the corresponding number key turns green.
 - Preset memories can be stored in number keys 1 to 10.
 - If there is already a preset memory that corresponds to the number key, then storing is not possible even if the key is held down.

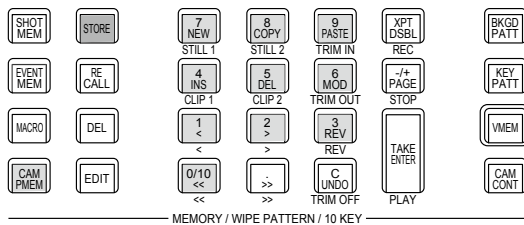

Recalling preset memories

- ① Operate the **[CAM PMEM]** button to make it turn amber.
- ② Operate the **[RECALL]** button to make it turn amber.
- ③ When a number key 1 to 10 is pressed, the preset memory that corresponds to the number key is executed.
 - The number key that corresponds to the preset memory being recalled blinks green.
 - The **[C]** (UNDO) button turns amber during recall and then goes out when recall is finished.
 - When recalling finishes, the number key that corresponds to the preset memory that was recalled last turns amber.
- ④ Recalling can be stopped by pressing the **[C]**(UNDO) button while recalling.

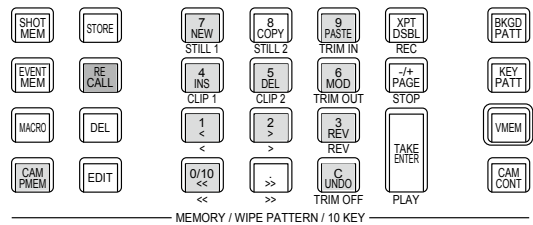

Deleting preset memories

- ① Operate the **[CAM PMEM]** button to make it turn amber.
- ② Operate the **[DEL]** button to make it turn red.
- ③ When a number key 1 to 10 is held down, the preset memory that corresponds to the number key can be deleted.
 - When deleting is finished, the number key that corresponds to the preset memory that was deleted turns off.

Remote camera link functions

Selecting a page of preset memories

- ① Operate the  button to make it turn amber.
- ② Page selection starts when the [PAGE] button is pressed.
 - The [PAGE] button turns amber when a page is selected. Number keys 1 to 10 correspond to page numbers 1 to 10.
- ③ Use the number keys 1 to 10 or the [PAGE] button to complete selection of the page.
 - If a number key 1 to 10 is pressed, the current page number changes to the value of the pressed number key.
 - When the [PAGE] button is pressed, the current page number is not changed.
- ④ If there is at least one preset memory in the page, the LED of the number key that corresponds to the page lights.
 - The number key that corresponds to the current page turns amber and all the other pages light green.
 - In the example in the figure below, page numbers 1, 5, 6, 7, 8, and 10 each contain at least one preset memory, and page number 1 is the current page.

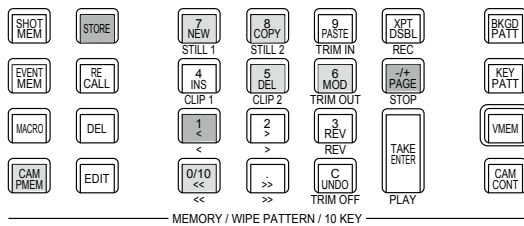

- The targets for project file storing and macro recording are as shown in the below table.

Storing project files	Selections with the STORE/RECALL/DEL buttons, Preset page numbers for input signals (for each connected camera)
Macro recording targets	Storing preset memories, Recalling preset memories, Deleting preset memories, Stopping with the [C](UNDO) button when recalling preset memories, Selections with the [STORE]/[RECALL]/[DEL] buttons when recalling preset memories, Page selections when recalling preset memories, Changing Preset Scope, Changing Preset Speed

ROI function

This unit is equipped with ROI (region of interest) functionality which enables you to extract the parts you need from the images input from the camera and assign them to crosspoints.

By extracting up to 4 parts that you need from the images of one camera, it is possible to produce the same images that might be possible with multiple cameras.

Furthermore, as this function is also available with the SDI/HDMI optional units, it is possible to extract 12 images from a maximum of 3 cameras.

■ Overview

Normal mode

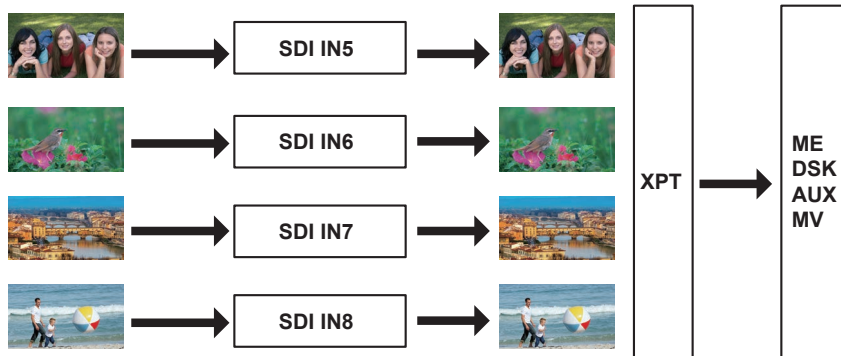

ROI mode

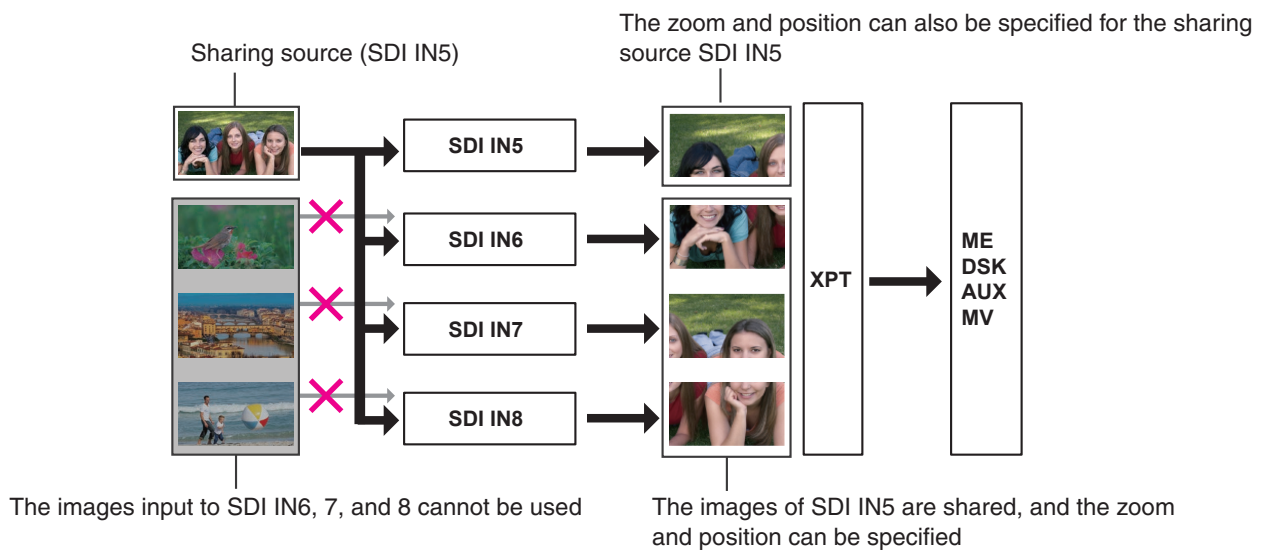

The above illustration shows an example with the camera connected to SDI IN5 on this unit. When in ROI mode, the images from SDI IN5 are shared with SDI IN6, SDI IN7, and SDI IN8.

You can individually adjust the size and position of each of the images in the sharing source, SDI IN5, and in the sharing destinations, SDI IN6, SDI IN7, and SDI IN8.

Those images can be selected with XPT, and can also be used by ME, DSK, AUX, and MV. The images for the sharing source can only come from SDI IN5.

ROI function

This function is also available with optional units AV-UHS5M1 (SDI Input Unit) and AV-UHS5M3 (HDMI Input Unit). In this case, the sharing source will be either IN-A1 or IN-B1 and the sharing destinations will be IN-A2-4 and IN-B2-4, respectively.

The inputs for which the ROI function is available are as follows:

- Standard SDI IN5 to 8
- IN-A1 to 4 on the SDI input unit (AV-UHS5M1)
- IN-B1 to 4 on the SDI input unit (AV-UHS5M1)
- IN-A1 to 4 on the HDMI input unit (AV-UHS5M3)
- IN-B1 to 4 on the HDMI input unit (AV-UHS5M3)

Furthermore, the relationships between the inputs that are the sharing sources and the inputs that are the sharing destinations are as follows:

Standard SDI input

	Sharing source	Sharing destinations		
SDI IN	SDI IN5	SDI IN6	SDI IN7	SDI IN8

- The ROI function cannot be used with standard SDI IN1 to 4 or standard HDMI IN1 and 2.

Option slot A

	Sharing source	Sharing destinations		
SDI IN	IN-A1	IN-A2	IN-A3	IN-A4
HDMI IN	IN-A1	IN-A2	IN-A3	IN-A4 (*1)

- It is not possible to share the images from option slot B.

*1: IN-A4 input on the HDMI input unit is enabled only in the ROI mode. Available in crosspoint and multi view.

Option slot B

	Sharing source	Sharing destinations		
SDI IN	IN-B1	IN-B2	IN-B3	IN-B4
HDMI IN	IN-B1	IN-B2	IN-B3	IN-B4 (*2)

- It is not possible to share the images from option slot A.

*2: IN-B4 input on the HDMI input unit is enabled only in the ROI mode. Available in crosspoint and multi view.

Notes

- The images for the sharing source can only come from SDI IN5, IN-A1, and IN-B1.
- The ROI mode is enabled if the system format is progressive, or if the system format is interlace and the input is progressive.
Also, the enabled inputs are progressive and PsF.
- LEVEL-B input is not supported at 1080/59.94p and 1080/50p in the ROI mode.
- When the system format of the switcher is 29.97/25 Hz, input with 1080i/1080PsF is enabled in the ROI mode.
- When the system format of the switcher is 59.94/50 Hz, input with 1080i/1080PsF is disabled in the ROI mode.

ROI function

ROI mode settings

- ① Press the  button to light its indicator and display the Config menu.
- ② Use [F1] to display the ROI sub menu.



- ③ Press [F2]/[F3]/[F4] to select an input that enables the ROI function in the Select item.

SDI IN	On	The ROI function is enabled with standard SDI input.
	Off	The ROI function is disabled with standard SDI input.
IN-A	On	The ROI function is enabled with option slot A.
	Off	The ROI function is disabled with option slot A.
		• Displayed when and SDI or HDMI input unit is installed in option slot A.
IN-B	On	The ROI function is enabled with option slot B.
	Off	The ROI function is disabled with option slot B.
		• Displayed when and SDI or HDMI input unit is installed in option slot B.

An indicator is displayed on the screen when the ROI function is enabled.

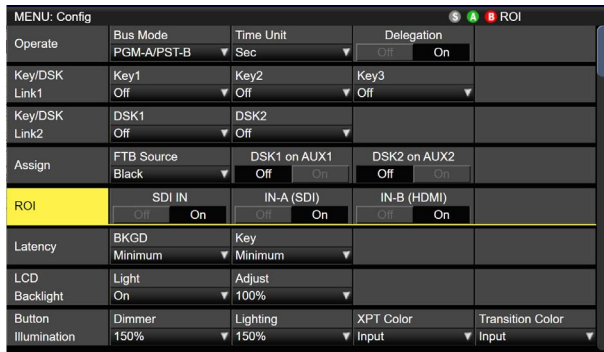

ROI function

Adjusting the position and range for ROI extraction

When the ROI function is enabled and selected, you can adjust the X and Y coordinates of the extraction position with the positioner in the positioner area, and also adjust the extraction range using the rotary encoder [Z] in the positioner area. These settings can also be made with menus.

① Press the  button to light its indicator and display the Input menu.

② Use [F1] to display the Input sub menu.



③ Use [F2] to select an input signal where the ROI function has been enabled in the Select item.

④ When it is an input signal where the ROI function has been enabled, use [F1] to display the ROI sub menu.

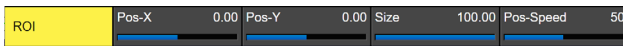

⑤ Use the positioner and rotary encoder [Z], or use [F2] to [F5], to set the extraction position and extraction range in each of the Pos-X, Pos-Y, Size, and Pos-Speed items.

	Description	Setting ranges	Default value
Pos-X	Adjusts the X position	-45.00 to 45.00	0.00
Pos-Y	Adjusts the Y position	-45.00 to 45.00	0.00
Size	Sets the range of extraction	10.00 to 100.00	100.00
Pos-Speed	Sets the speed of the positioner movement	1 to 100	50

The setting ranges for the extraction position and the extraction range

The settings for Pos-X, Pos-Y, and Size are reflected as shown in the diagram below. However, you cannot set so that they go beyond the bounds of the screen as shown by the red frame in the below diagram.

Even if you try to change X-Pos, Y-Pos, and Size as shown by the red frame, the settings can only be made up to the changes possible for X-Pos, Y-Pos, and Size.

The setting changes for Size take priority, so if the changes to Size mean that the settings become like the red frame in the diagram below, then X-Pos and Y-Pos will be changed in conjunction so that they fit within the screen setting range.

You cannot adjust the range beyond the bounds of the screen.

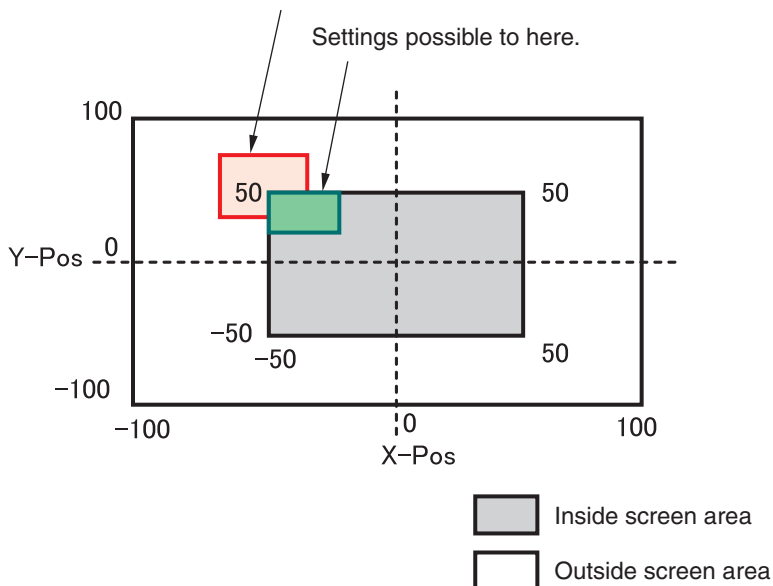

ROI function

ROI adjustments from the CAM CONT screen

When the ROI function is enabled and selected, in the CAM CONT screen, you can also select the target input signal and adjust the extraction position and extraction range.

- Press the [DISP/CAM] button to make it turn green and select the CAM bus.

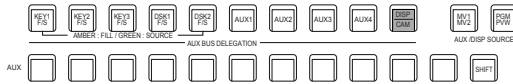

- Select an input signal where the ROI function has been enabled as the source for the CAM bus.
 - The selected bus turns green.

Inputs which enable ROI adjustments are as follows:

- SDI IN5 to SDI IN8
- IN-A1 to IN-A4
- IN-B1 to IN-B4

- When you press the [CAM CONT] button, the display on the built-in display of this unit changes and the [CAM CONT] button turns amber.
- Use the positioner to adjust the extraction position.

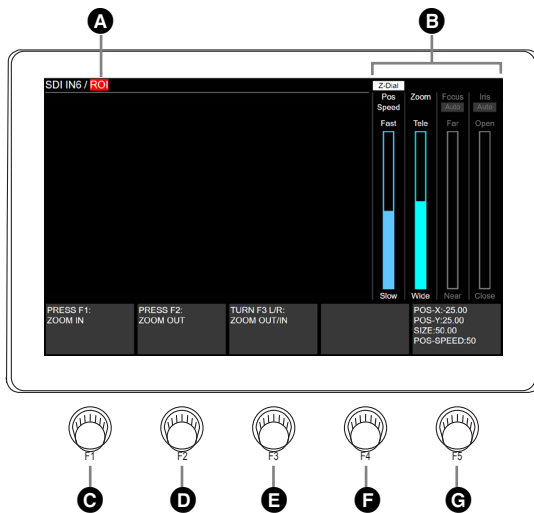

A	ROI mode indicator	Indicates that the input signal is in the ROI mode.
B	Z-Dial	Indicates the application for [Z]. Each time you press [Z], operation switches between Pos-Speed and Zoom.
	Pos Speed	Indicates the status of the speed of movement of the position for extraction. "Fast" indicates fast operation and "Slow" indicates slow operation.
	Zoom	Indicates the size of the range of extraction.
	Focus	This is grayed out because it is not used when adjusting ROI.
	Iris	This is grayed out because it is not used when adjusting ROI.
C	[F1]	The range of extraction gets smaller when you press this button. An explanation is also displayed on the Menu screen.
D	[F2]	The range of extraction gets bigger when you press this button. An explanation is also displayed on the Menu screen.
E	[F3]	Turn left or right to adjust the range of extraction. The range gets bigger when turned to the left and gets smaller when turned to the right. An explanation is also displayed on the Menu screen.
F	[F4]	Not used.
G	[F5]	Displays the setting values for X-Pos, Y-Pos, Size, and Pos-Speed in the Input menu.

- If you transition to this screen while controlling a remote camera, you will not be able to perform any camera operations.

ROI function

ROI preset memory

When the ROI function is enabled on this unit, you can save the extraction position and extraction range for each of the target input signals as ROI preset memories and then play them back.

- ① Press the  button.
- ② The display on the built-in LCD of the unit switches.
- ③ Use the positioner to adjust the extraction position.
 - It is possible to save, play back, and delete the ROI preset memories using the number keys.
 - It is possible to change the ROI preset speed using [F5].
Also, by turning [F5] while pressing it, you can change the settings in 1-second increments.

The ROI preset memories are saved in the unit, with 10 available for each input.
If there is an ROI preset memory saved that corresponds to a number key, the LED of the number key lights.
The number key that corresponds to the ROI preset memory that was recalled last on this unit turns amber and all others turn green.

You can select the operation for the ROI preset memory each time you press the [STORE]/[RECALL]/[DEL] buttons.

- While the [STORE] button is lit red, you can store ROI preset memories by holding down the number keys.
- While the [RECALL] button is lit amber, you can execute ROI preset memories by pressing the number keys.
- While the [DEL] button is lit red, you can delete ROI preset memories by holding down the number keys.

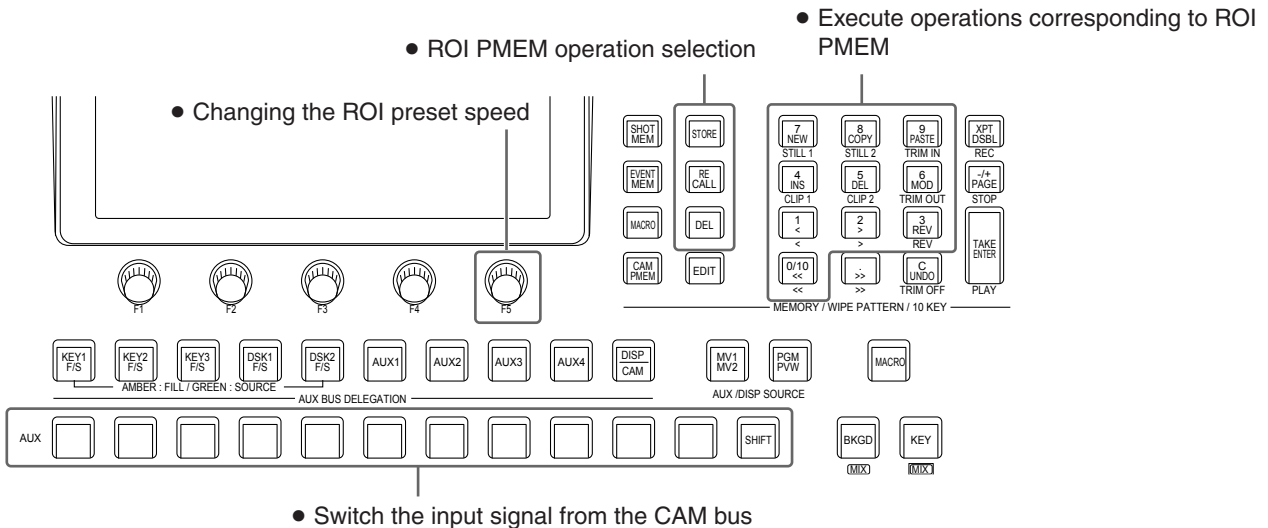

ROI function



A	Input signal information display	Indicates that the input signal is in the ROI mode.
B	Z-Dial	Indicates the application for [Z]. Each time you press [Z], operation switches between Pos-Speed and Zoom.
	Pos Speed	Indicates the status of the speed of movement of the position for extraction. "Fast" indicates fast operation and "Slow" indicates slow operation.
	Zoom	Indicates the size of the range of extraction.
	Focus	This is grayed out because it is not used when adjusting ROI.
	Iris	This is grayed out because it is not used when adjusting ROI.
C	[F1]	Not used.
D	[F2]	Not used.
E	[F3]	Not used.
F	[F4]	Not used.
G	[F5]	Displays the dissolve time when recalling an ROI preset. You can set a time here to smoothly switch from the current image to the image in the registered state.

- The thumbnail displayed when saving the preset will be of the input image when the save was executed. You cannot save a different thumbnail after the preset has been saved.

The dissolve time when recalling an ROI preset can also be set in the Input menu. It can be set individually for each of the input signals where the ROI function is enabled.

- ① Press the **[IN/OUT]** button to light its indicator and display the Input menu.
- ② Use [F1] to display the Input sub menu.



- ③ Use [F2] to select an input signal where the ROI function has been enabled in the Select item.
- ④ Use [F1] to display the ROI Preset sub menu.



- ⑤ Use [F2] to set the dissolve time when recalling an ROI preset in the TransTime item.

External interfaces

Setting the GPI I/O

The user can set the functions that are to be controlled from the GPI ports and set whether to enable the control.

- ① Press the  button to light its indicator, and display the Config menu.
- ② Use [F1] to display the GPI-In Setting sub menu (or GPI-Out Setting sub menu).

GPI-In Setting	GPI-In Enable OFF On	AUX Sel AUX1	
----------------	-------------------------	-----------------	--

GPI-Out Setting	GPI-Out Enable OFF On	AUX Tly Sel AUX1	
-----------------	--------------------------	---------------------	--

- ③ Use [F2] to set “On” or “Off” for the control to be exercised from the ports using the GPI-In Enable item (or GPI-Out Enable item).
- ④ Use [F3] to set the AUX bus to be used to notify the tally using the AUX Sel item.
- ⑤ Use [F1] to display GPI-In Port 1/2 sub menu and GPI-In Port 2/2 sub menu (or GPI-Out Port 1/5 sub menu to GPI-Out Port 5/5 sub menu).

MENU : Config				
GPI-In Port 1/2	Port1Assign No Assign	Port2Assign No Assign	Port3Assign No Assign	Port4Assign No Assign

MENU : Config				
GPI-In Port 2/2	Port5Assign No Assign	Port6Assign No Assign	Port7Assign No Assign	Port8Assign No Assign

MENU : Config				
GPI-Out Port 1/5	Port1Assign No Assign	Port2Assign No Assign	Port3Assign No Assign	Port4Assign No Assign

MENU : Config				
GPI-Out Port 2/5	Port5Assign No Assign	Port6Assign No Assign	Port7Assign No Assign	Port8Assign No Assign

MENU : Config				
GPI-Out Port 3/5	Port9Assign No Assign	Port10Assign No Assign	Port11Assign No Assign	Port12Assign No Assign

MENU : Config				
GPI-Out Port 4/5	Port13Assign No Assign	Port14Assign No Assign	Port15Assign No Assign	Port16Assign No Assign

MENU : Config				
GPI-Out Port 5/5	Port17Assign No Assign	Port18Assign No Assign	Port19Assign No Assign	

- ⑥ Use [F2] to [F5] to allocate the functions to be assigned to the respective pin numbers.
 - ☞ Refer to “Control using the GPI Input port” and “Output from the GPI Output port”.
- Settings for the GPI-In Enable (or GPI-Out Enable) item can be assigned to one of the user buttons.
 - ☞ Refer to “Setting the user buttons”.

External interfaces

■ Control using the GPI Input port

Assign Item	Description of function assigned	Control method
AUTO	AUTO button in transition area	Operations are performed using contact inputs (30 ms or more).
CUT	CUT button in transition area	
KEY ON	KEY1 to KEY3 button in transition area	
DSK ON	DSK1, DSK2 button in transition area	
FTB	FTB button in transition area	
BKGD AUTO	AUTO button when the background is selected	
BKGD CUT	CUT button when the background is selected	
KEY AUTO	AUTO button when the key is selected	
KEY CUT	CUT button when the key is selected	
REC Still1	Still1 recording	
REC Still2	Still2 recording	
REC Clip1	Clip1 recording start	
REC Clip2	Clip2 recording start	
STOP Clip1	Clip1 recording stop or playback stop	
STOP Clip2	Clip2 recording stop or playback stop	
PLAY Clip1	Clip1 playback start	
PLAY Clip2	Clip2 playback start	
AUX XPT 1 to 24	Crosspoint buttons (1 to 24) used to switch the AUX buses. ● Select the AUX buses (AUX1 to AUX4) to be controlled using the menu.	
TlyG1 DSBL	Red tally signal is not output	Functions are enabled using contact inputs (or disabled in open status).
TlyG2 DSBL	Green tally signal is not output	
AUXTly DSBL	AUX tally signal is not output	
No Assign	No function assigned	

External interfaces

■ Output from the GPI Output port

Assign Item	Description of function assigned	Output
CUT	Cut transition executed	Low pulses are output (approx. 50 to 60 ms).
KEY1 ON to KEY3 ON	Key1 to 3 transition start	
DSK1 ON to DSK2 ON	DSK1 to 2 transition start	
FTB ON	FTB transition start	
BKGD CUT	Cut transition for the background executed	
KEY1 CUT	Cut transition for a key1 executed	
EVENTMEM	Event set by event memory executed	
AUTO	Auto transition execution in progress	A low level is output.
BKGD AUTO	Auto transition execution in progress for background	
KEY1 AUTO	Auto transition execution in progress for key1	
TlyG1 SDI IN1 to SDI IN8	Red tally for SDI IN1 to SDI IN8	A low level is output during tally output.
TlyG1 HDMI IN1 to HDMI IN2	Red tally for HDMI IN1 to HDMI IN2	
TlyG1 IN-A1 to IN-A4	Red tally for IN-A1 to IN-A4	
TlyG1 IN-B1 to IN-B4	Red tally for IN-B1 to IN-B4	
TlyG2 SDI IN1 to SDI IN8	Green tally for SDI IN1 to SDI IN8	
TlyG2 HDMI IN1 to HDMI IN2	Green tally for HDMI IN1 to HDMI IN2	
TlyG2 IN-A1 to IN-A4	Green tally for IN-A1 to IN-A4	
TlyG2 IN-B1 to IN-B4	Green tally for IN-B1 to IN-B4	
AUXTly SDI IN1 to SDI IN8	When SDI IN1 to SDI IN8* have been selected by the AUX bus	A low level is output while the inputs are selected.
AUXTly HDMI IN1 to HDMI IN2	When HDMI IN1 to HDMI IN2* have been selected by the AUX bus	
AUXTly IN-A1 to IN-A4	When IN-A1 to IN-A4* have been selected by the AUX bus	
AUXTly IN-B1 to IN-B4	When IN-B1 to IN-B4* have been selected by the AUX bus	
No Assign	No function assigned	

*: Select the AUX buses (AUX1 to AUX4) whose signals are to be output using the menu.

External interfaces

Example of GPI Out and ALARM connections

Ensure that the conditions given below are satisfied.

Dielectric strength: Max. DC 24 V
 Current: Max. 50 mA

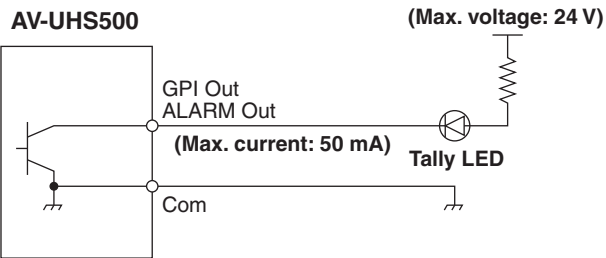

Example of GPI In connections

Provide contact inputs.

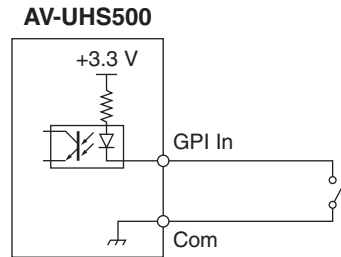

TALLY/GPI 1

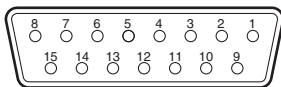

TALLY/GPI 2

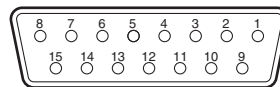

Pin No.	Signal name
1	GPI-Out1
9	GPI-Out9
2	GPI-Out2
10	ALARM Out
3	GPI-Out3
11	GPI-In1
4	GPI-Out4
12	GPI-In2
5	GPI-Out5
13	GPI-In3
6	GPI-Out6
14	GPI-In4
7	GPI-Out7
15	GPI-Com
8	GPI-Out8

Pin No.	Signal name
1	GPI-Out10
9	GPI-Out18
2	GPI-Out11
10	GPI-Out19
3	GPI-Out12
11	GPI-In5
4	GPI-Out13
12	GPI-In6
5	GPI-Out14
13	GPI-In7
6	GPI-Out15
14	GPI-In8
7	GPI-Out16
15	GPI-Com
8	GPI-Out17

LAN

Connect the unit and computer or the unit and an external device*.

*: An external device can be controlled from the unit.

- Use a LAN cable (category 5e or above).

External interfaces

Controlling with external panels

With this unit, you can perform the following operations from external panels (*) connected via an IP network:

- Select materials for each bus
- Execute video transitions
- Play back macro memories
- Play back shot memories
- Crosspoint selection for each bus

*: This unit supports the LBP series from LAWO. Consult LAWO for LBP series settings and operations.

Preparations

Use a LAN cable to connect the external panel to the LAN connector on the back of the unit.
It is possible to connect a maximum of 20 external panels.
When connecting multiple external panels, connect via a hub.

External panel settings

Check the following settings on this unit, then make the settings on the connected external panels:

- System menu → Network1 sub menu
Take the address value set in the IP Address item of this sub menu and set it as the IP address of the device that will be the target of the external panel operations.
- System menu → ExtPanel Info sub menu
Take the port number set in the Port No item of this sub menu and set it as the port number of the device that will be the target of the external panel operations.

Also set the subnet mask (Network2 sub menu) and the default gateway (Network3 sub menu) according to the network environment connected.

Settings on this unit when external panels are connected

Receiving port number settings

- ① Press the  button to light its indicator, and display the System menu.
- ② Use [F1] to display the ExtPanel Info sub menu.

ExtPanel Info	Disable/Enable Disable Enable	PortNo	62010
---------------	----------------------------------	--------	-------

- ③ Press [F2] to enable/disable the external panel function in the Disable/Enable item.
- ④ Use [F3] to set the receiving port number used by this unit.

Possible setting range	62000 to 65535
Default value	62010

Shot memory playback target settings

Set the playback targets for when shot memories of this unit are played back by operations on the external panels.

- ① Press the  button to light its indicator, and display the System menu.
- ② Use [F1] to display the ExtPanelIP SMEMRecall1/2 sub menu.

ExtPanelIP	ME	DSK	AUX
SMEMRecall1	Off On	Off On	Off On
ExtPanelIP	CBGD	XPT	
SMEMRecall2	Off On	Off On	

- ③ Use [F2] to [F4] to set the playback targets for the shot memory.
 - ME, DSK, AUX, color background, and crosspoint area can be individually turned ON/OFF.

External interfaces

List of bus IDs and source IDs

When operations are performed on external panels, crosspoint setting commands are issued that specify the materials (Source) for the buses (Destination).

When this unit receives the crosspoint setting command from the external panel, materials are selected and video transitions are executed according to the bus and material combinations specified in the command.

This section describes the IDs (numbers) used by this unit to identify each bus and each material.

IDs can be categorized broadly into the following 2 types:

1) Normal bus IDs and material IDs

IDs that specify the buses inside the switcher (ME1PGM, AUX1, etc.) and the switcher materials (SDI IN1, CBGD1, STILL1-V, etc.).

Use a number between 1 and 512.

2) Extended bus IDs and extended material IDs

IDs used for playback of video transitions, macro memories, and shot memories.

When this unit receives a crosspoint setting command in which the same extended ID is specified for the bus and the material, the corresponding function is executed.

For example, when a command is received that specifies the ME1 AUTO material (ID: 522) for the ME1 AUTO bus (ID: 522), an AUTO transition is executed at ME1.

Use a number between 513 and 1023.

Executable operations	Specified bus and material
ME key transition	ME1 KEY1 AUTO to ME1 KEY3 AUTO
ME key transition (CUT)	ME1 KEY1 CUT to ME1 KEY3 CUT
ME AUTO transition	ME1 BKGD AUTO
ME CUT transition	ME1 BKGD CUT
DSK transition	DSK1 AUTO to DSK2 AUTO
DSK transition (CUT)	DSK1 CUT to DSK2 CUT
Playing back macro registered memories	MACROPLAY1-1 to MACROPLAY10-10
Playing back shot memory registered memories	SHOTPLAY1-1 to SHOTPLAY10-10
Crosspoint selection for each bus	XPT1 to XPT24

- Consult LAWO for details on how to assign IDs to the operations of each of the buttons on the LBP series.

External interfaces

Bus ID

ID	Bus	ID	Bus	ID	Bus	ID	Bus	ID	Bus
1	ME1PGM	100	DSK2-S	149	–	162	MV1-10	176	MV2-8
2	ME1PVW	101	–	150	VMEM-V	163	MV1-11	177	MV2-9
3	ME1KEY1-F	⋮		151	VMEM-K	164	MV1-12	178	MV2-10
4	ME1KEY1-S	112	–	152	–	165	MV1-13	179	MV2-11
5	ME1KEY2-F	113	AUX1	⋮		166	MV1-14	180	MV2-12
6	ME1KEY2-S	114	AUX2	153	MV1-1	167	MV1-15	181	MV2-13
7	ME1KEY3-F	115	AUX3	154	MV1-2	168	MV1-16	182	MV2-14
8	ME1KEY3-S	116	AUX4	155	MV1-3	169	MV2-1	183	MV2-15
9	–	117	–	156	MV1-4	170	MV2-2	184	MV2-16
⋮		⋮		157	MV1-5	171	MV2-3	185	–
96	–	140	–	158	MV1-6	172	MV2-4	⋮	
97	DSK1-F	141	DISP	159	MV1-7	173	MV2-5	512	–
98	DSK1-S	142	–	160	MV1-8	174	MV2-6		
99	DSK2-F	⋮		161	MV1-9	175	MV2-7		

--: Unused ID

Source ID

ID	Source	ID	Source	ID	Source	ID	Source	ID	Source
1	IN1	148	BLACK	165	MV1	⋮		252	–
2	IN2	149	STILL1V	166	MV2	208	–	⋮	
3	SDI_IN3	150	STILL1K	167	–	209	ME PGM	539	–
4	SDI_IN4	151	STILL2V	⋮		210	–	540	OPA_IN1
5	SDI_IN5	152	STILL2K	170	–	⋮		541	OPA_IN2
6	SDI_IN6	153	–	171	Key Out	226	–	542	OPA_IN3
7	SDI_IN7	⋮		172	CLN	227	AUX1	543	OPA_IN4
8	SDI_IN8	157	CLIP1V	173	–	228	AUX2	544	OPB_IN1
9	–	158	CLIP1K	⋮		229	AUX3	545	OPB_IN2
⋮		159	CLIP2V	200	–	230	AUX4	546	OPB_IN3
144	–	160	CLIP2K	201	PGM	231	–	547	OPB_IN4
145	CBGD1	161	–	202	–	⋮		548	–
146	CBGD2	⋮		203	PVW	250	–	⋮	
147	CBAR	164	–	204	–	251	CLOCK	553	–

--: Unused ID

External interfaces

Extended bus ID

ID	Bus	ID	Bus	ID	Bus	ID	Bus	ID	Bus
513	–	633	MACROPLAY3-4	679	MACROPLAY7-10	725	SHOTPLAY2-6	771	SHOTPLAY7-2
514	ME1 KEY1 AUTO	634	MACROPLAY3-5	680	MACROPLAY8-1	726	SHOTPLAY2-7	772	SHOTPLAY7-3
515	ME1 KEY2 AUTO	635	MACROPLAY3-6	681	MACROPLAY8-2	727	SHOTPLAY2-8	773	SHOTPLAY7-4
516	ME1 KEY3 AUTO	636	MACROPLAY3-7	682	MACROPLAY8-3	728	SHOTPLAY2-9	774	SHOTPLAY7-5
517	–	637	MACROPLAY3-8	683	MACROPLAY8-4	729	SHOTPLAY2-10	775	SHOTPLAY7-6
518	ME1 KEY1 CUT	638	MACROPLAY3-9	684	MACROPLAY8-5	730	SHOTPLAY3-1	776	SHOTPLAY7-7
519	ME1 KEY2 CUT	639	MACROPLAY3-10	685	MACROPLAY8-6	731	SHOTPLAY3-2	777	SHOTPLAY7-8
520	ME1 KEY3 CUT	640	MACROPLAY4-1	686	MACROPLAY8-7	732	SHOTPLAY3-3	778	SHOTPLAY7-9
521	–	641	MACROPLAY4-2	687	MACROPLAY8-8	733	SHOTPLAY3-4	779	SHOTPLAY7-10
522	ME1 BKGD AUTO	642	MACROPLAY4-3	688	MACROPLAY8-9	734	SHOTPLAY3-5	780	SHOTPLAY8-1
523	ME1 BKGD CUT	643	MACROPLAY4-4	689	MACROPLAY8-10	735	SHOTPLAY3-6	781	SHOTPLAY8-2
524	–	644	MACROPLAY4-5	690	MACROPLAY9-1	736	SHOTPLAY3-7	782	SHOTPLAY8-3
⋮		645	MACROPLAY4-6	691	MACROPLAY9-2	737	SHOTPLAY3-8	783	SHOTPLAY8-4
593	–	646	MACROPLAY4-7	692	MACROPLAY9-3	738	SHOTPLAY3-9	784	SHOTPLAY8-5
594	DSK1 AUTO	647	MACROPLAY4-8	693	MACROPLAY9-4	739	SHOTPLAY3-10	785	SHOTPLAY8-6
595	DSK2 AUTO	648	MACROPLAY4-9	694	MACROPLAY9-5	740	SHOTPLAY4-1	786	SHOTPLAY8-7
596	–	649	MACROPLAY4-10	695	MACROPLAY9-6	741	SHOTPLAY4-2	787	SHOTPLAY8-8
597	–	650	MACROPLAY5-1	696	MACROPLAY9-7	742	SHOTPLAY4-3	788	SHOTPLAY8-9
598	DSK1 CUT	651	MACROPLAY5-2	697	MACROPLAY9-8	743	SHOTPLAY4-4	789	SHOTPLAY8-10
599	DSK2 CUT	652	MACROPLAY5-3	698	MACROPLAY9-9	744	SHOTPLAY4-5	790	SHOTPLAY9-1
600	–	653	MACROPLAY5-4	699	MACROPLAY9-10	745	SHOTPLAY4-6	791	SHOTPLAY9-2
⋮		654	MACROPLAY5-5	700	MACROPLAY10-1	746	SHOTPLAY4-7	792	SHOTPLAY9-3
609	–	655	MACROPLAY5-6	701	MACROPLAY10-2	747	SHOTPLAY4-8	793	SHOTPLAY9-4
610	MACROPLAY1-1	656	MACROPLAY5-7	702	MACROPLAY10-3	748	SHOTPLAY4-9	794	SHOTPLAY9-5
611	MACROPLAY1-2	657	MACROPLAY5-8	703	MACROPLAY10-4	749	SHOTPLAY4-10	795	SHOTPLAY9-6
612	MACROPLAY1-3	658	MACROPLAY5-9	704	MACROPLAY10-5	750	SHOTPLAY5-1	796	SHOTPLAY9-7
613	MACROPLAY1-4	659	MACROPLAY5-10	705	MACROPLAY10-6	751	SHOTPLAY5-2	797	SHOTPLAY9-8
614	MACROPLAY1-5	660	MACROPLAY6-1	706	MACROPLAY10-7	752	SHOTPLAY5-3	798	SHOTPLAY9-9
615	MACROPLAY1-6	661	MACROPLAY6-2	707	MACROPLAY10-8	753	SHOTPLAY5-4	799	SHOTPLAY9-10
616	MACROPLAY1-7	662	MACROPLAY6-3	708	MACROPLAY10-9	754	SHOTPLAY5-5	800	SHOTPLAY10-1
617	MACROPLAY1-8	663	MACROPLAY6-4	709	MACROPLAY10-10	755	SHOTPLAY5-6	801	SHOTPLAY10-2
618	MACROPLAY1-9	664	MACROPLAY6-5	710	SHOTPLAY1-1	756	SHOTPLAY5-7	802	SHOTPLAY10-3
619	MACROPLAY1-10	665	MACROPLAY6-6	711	SHOTPLAY1-2	757	SHOTPLAY5-8	803	SHOTPLAY10-4
620	MACROPLAY2-1	666	MACROPLAY6-7	712	SHOTPLAY1-3	758	SHOTPLAY5-9	804	SHOTPLAY10-5
621	MACROPLAY2-2	667	MACROPLAY6-8	713	SHOTPLAY1-4	759	SHOTPLAY5-10	805	SHOTPLAY10-6
622	MACROPLAY2-3	668	MACROPLAY6-9	714	SHOTPLAY1-5	760	SHOTPLAY6-1	806	SHOTPLAY10-7
623	MACROPLAY2-4	669	MACROPLAY6-10	715	SHOTPLAY1-6	761	SHOTPLAY6-2	807	SHOTPLAY10-8
624	MACROPLAY2-5	670	MACROPLAY7-1	716	SHOTPLAY1-7	762	SHOTPLAY6-3	808	SHOTPLAY10-9
625	MACROPLAY2-6	671	MACROPLAY7-2	717	SHOTPLAY1-8	763	SHOTPLAY6-4	809	SHOTPLAY10-10
626	MACROPLAY2-7	672	MACROPLAY7-3	718	SHOTPLAY1-9	764	SHOTPLAY6-5	810	XPT1
627	MACROPLAY2-8	673	MACROPLAY7-4	719	SHOTPLAY1-10	765	SHOTPLAY6-6	811	XPT2
628	MACROPLAY2-9	674	MACROPLAY7-5	720	SHOTPLAY2-1	766	SHOTPLAY6-7	812	XPT3
629	MACROPLAY2-10	675	MACROPLAY7-6	721	SHOTPLAY2-2	767	SHOTPLAY6-8	813	XPT4
630	MACROPLAY3-1	676	MACROPLAY7-7	722	SHOTPLAY2-3	768	SHOTPLAY6-9	814	XPT5
631	MACROPLAY3-2	677	MACROPLAY7-8	723	SHOTPLAY2-4	769	SHOTPLAY6-10	815	XPT6
632	MACROPLAY3-3	678	MACROPLAY7-9	724	SHOTPLAY2-5	770	SHOTPLAY7-1	816	XPT7

–: Disabled ID (-1) sent

External interfaces

Extended bus ID (continued)

ID	Bus
817	XPT8
818	XPT9
819	XPT10
820	XPT11
821	XPT12
822	XPT13
823	XPT14
824	XPT15
825	XPT16
826	XPT17
827	XPT18
828	XPT19
829	XPT20
830	XPT21
831	XPT22
832	XPT23
833	XPT24
834	-
⋮	
1024	-

--: Disabled ID (-1) sent

Extended Source ID

ID	Source	ID	Source	ID	Source
513	--	633	MACROPLAY3-4	679	MACROPLAY7-10
514	ME1 KEY1 AUTO	634	MACROPLAY3-5	680	MACROPLAY8-1
515	ME1 KEY2 AUTO	635	MACROPLAY3-6	681	MACROPLAY8-2
516	ME1 KEY3 AUTO	636	MACROPLAY3-7	682	MACROPLAY8-3
517	--	637	MACROPLAY3-8	683	MACROPLAY8-4
518	ME1 KEY1 CUT	638	MACROPLAY3-9	684	MACROPLAY8-5
519	ME1 KEY2 CUT	639	MACROPLAY3-10	685	MACROPLAY8-6
520	ME1 KEY3 CUT	640	MACROPLAY4-1	686	MACROPLAY8-7
521	--	641	MACROPLAY4-2	687	MACROPLAY8-8
522	ME1 BKGD AUTO	642	MACROPLAY4-3	688	MACROPLAY8-9
523	ME1 BKGD CUT	643	MACROPLAY4-4	689	MACROPLAY8-10
524	--	644	MACROPLAY4-5	690	MACROPLAY9-1
⋮		645	MACROPLAY4-6	691	MACROPLAY9-2
593	--	646	MACROPLAY4-7	692	MACROPLAY9-3
594	DSK1 AUTO	647	MACROPLAY4-8	693	MACROPLAY9-4
595	DSK2 AUTO	648	MACROPLAY4-9	694	MACROPLAY9-5
596	--	649	MACROPLAY4-10	695	MACROPLAY9-6
597	--	650	MACROPLAY5-1	696	MACROPLAY9-7
598	DSK1 CUT	651	MACROPLAY5-2	697	MACROPLAY9-8
599	DSK2 CUT	652	MACROPLAY5-3	698	MACROPLAY9-9
600	--	653	MACROPLAY5-4	699	MACROPLAY9-10
⋮		654	MACROPLAY5-5	700	MACROPLAY10-1
609	--	655	MACROPLAY5-6	701	MACROPLAY10-2
610	MACROPLAY1-1	656	MACROPLAY5-7	702	MACROPLAY10-3
611	MACROPLAY1-2	657	MACROPLAY5-8	703	MACROPLAY10-4
612	MACROPLAY1-3	658	MACROPLAY5-9	704	MACROPLAY10-5
613	MACROPLAY1-4	659	MACROPLAY5-10	705	MACROPLAY10-6
614	MACROPLAY1-5	660	MACROPLAY6-1	706	MACROPLAY10-7
615	MACROPLAY1-6	661	MACROPLAY6-2	707	MACROPLAY10-8
616	MACROPLAY1-7	662	MACROPLAY6-3	708	MACROPLAY10-9
617	MACROPLAY1-8	663	MACROPLAY6-4	709	MACROPLAY10-10
618	MACROPLAY1-9	664	MACROPLAY6-5	710	SHOTPLAY1-1
619	MACROPLAY1-10	665	MACROPLAY6-6	711	SHOTPLAY1-2
620	MACROPLAY2-1	666	MACROPLAY6-7	712	SHOTPLAY1-3
621	MACROPLAY2-2	667	MACROPLAY6-8	713	SHOTPLAY1-4
622	MACROPLAY2-3	668	MACROPLAY6-9	714	SHOTPLAY1-5
623	MACROPLAY2-4	669	MACROPLAY6-10	715	SHOTPLAY1-6
624	MACROPLAY2-5	670	MACROPLAY7-1	716	SHOTPLAY1-7
625	MACROPLAY2-6	671	MACROPLAY7-2	717	SHOTPLAY1-8
626	MACROPLAY2-7	672	MACROPLAY7-3	718	SHOTPLAY1-9
627	MACROPLAY2-8	673	MACROPLAY7-4	719	SHOTPLAY1-10
628	MACROPLAY2-9	674	MACROPLAY7-5	720	SHOTPLAY2-1
629	MACROPLAY2-10	675	MACROPLAY7-6	721	SHOTPLAY2-2
630	MACROPLAY3-1	676	MACROPLAY7-7	722	SHOTPLAY2-3
631	MACROPLAY3-2	677	MACROPLAY7-8	723	SHOTPLAY2-4
632	MACROPLAY3-3	678	MACROPLAY7-9	724	SHOTPLAY2-5

--: Unused ID

External interfaces

Extended Source ID (continued)

ID	Source	ID	Source	ID	Source
725	SHOTPLAY2-6	771	SHOTPLAY7-2	817	XPT8
726	SHOTPLAY2-7	772	SHOTPLAY7-3	818	XPT9
727	SHOTPLAY2-8	773	SHOTPLAY7-4	819	XPT10
728	SHOTPLAY2-9	774	SHOTPLAY7-5	820	XPT11
729	SHOTPLAY2-10	775	SHOTPLAY7-6	821	XPT12
730	SHOTPLAY3-1	776	SHOTPLAY7-7	822	XPT13
731	SHOTPLAY3-2	777	SHOTPLAY7-8	823	XPT14
732	SHOTPLAY3-3	778	SHOTPLAY7-9	824	XPT15
733	SHOTPLAY3-4	779	SHOTPLAY7-10	825	XPT16
734	SHOTPLAY3-5	780	SHOTPLAY8-1	826	XPT17
735	SHOTPLAY3-6	781	SHOTPLAY8-2	827	XPT18
736	SHOTPLAY3-7	782	SHOTPLAY8-3	828	XPT19
737	SHOTPLAY3-8	783	SHOTPLAY8-4	829	XPT20
738	SHOTPLAY3-9	784	SHOTPLAY8-5	830	XPT21
739	SHOTPLAY3-10	785	SHOTPLAY8-6	831	XPT22
740	SHOTPLAY4-1	786	SHOTPLAY8-7	832	XPT23
741	SHOTPLAY4-2	787	SHOTPLAY8-8	833	XPT24
742	SHOTPLAY4-3	788	SHOTPLAY8-9	834	-
743	SHOTPLAY4-4	789	SHOTPLAY8-10	:	
744	SHOTPLAY4-5	790	SHOTPLAY9-1	1024	-
745	SHOTPLAY4-6	791	SHOTPLAY9-2		
746	SHOTPLAY4-7	792	SHOTPLAY9-3		
747	SHOTPLAY4-8	793	SHOTPLAY9-4		
748	SHOTPLAY4-9	794	SHOTPLAY9-5		
749	SHOTPLAY4-10	795	SHOTPLAY9-6		
750	SHOTPLAY5-1	796	SHOTPLAY9-7		
751	SHOTPLAY5-2	797	SHOTPLAY9-8		
752	SHOTPLAY5-3	798	SHOTPLAY9-9		
753	SHOTPLAY5-4	799	SHOTPLAY9-10		
754	SHOTPLAY5-5	800	SHOTPLAY10-1		
755	SHOTPLAY5-6	801	SHOTPLAY10-2		
756	SHOTPLAY5-7	802	SHOTPLAY10-3		
757	SHOTPLAY5-8	803	SHOTPLAY10-4		
758	SHOTPLAY5-9	804	SHOTPLAY10-5		
759	SHOTPLAY5-10	805	SHOTPLAY10-6		
760	SHOTPLAY6-1	806	SHOTPLAY10-7		
761	SHOTPLAY6-2	807	SHOTPLAY10-8		
762	SHOTPLAY6-3	808	SHOTPLAY10-9		
763	SHOTPLAY6-4	809	SHOTPLAY10-10		
764	SHOTPLAY6-5	810	XPT1		
765	SHOTPLAY6-6	811	XPT2		
766	SHOTPLAY6-7	812	XPT3		
767	SHOTPLAY6-8	813	XPT4		
768	SHOTPLAY6-9	814	XPT5		
769	SHOTPLAY6-10	815	XPT6		
770	SHOTPLAY7-1	816	XPT7		

--: Unused ID

External interfaces

External Control

<Overview>

It is possible to switch the materials of all buses on the AV-UHS500 and transmit and receive the material name information of all buses on the AV-UHS500 with external devices connected to the network such as system controllers and tally interfaces.

It is also possible to switch the Source Link settings (Master/Slave) from external devices.

It is possible to transmit and receive tally information and Source ID information using a transmission format that is compatible with TSL UMD Protocol V5.0.

By connecting to the Remote Camera Controller AW-RP series from Panasonic via IP, it is possible to switch material, transmit and receive Tally information, perform focus assist, and acquire material names for the AV-UHS500 buses using the AW-RP series camera selector.

- Refer to the operating instructions for AW-RP series for information about control bus settings, etc.

<Preparation>

Use a LAN cable to connect the external device to the LAN connector on the rear of AV-UHS500.

The unit supports 20 IP connections. When connecting to multiple external devices, connect via a hub. Set IP address so there is no duplication.

You can confirm the AV-UHS500 network settings with <CONF/SYS> button → [SYSTEM] → [NetWork1] tab, [NetWork2] tab.

The initial settings are; IP Address: "192.168.0.8", Subnet Mask: "255.255.255.0".

<Settings>

- Press the  button to light its indicator, and display the System menu.

- Use [F1] to display the ExtControl Switcher sub menu.

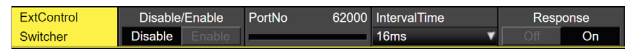

- Press [F2] to enable/disable the External Control function in the Disable/Enable item.
- Use [F3] to set the network in the PortNo item.
- Use [F4] to set the command transmission interval in the IntervalTime item.
- Use [F5] to make settings for the sending of change notifications for the transmission source in the Response item.

On	Send a change notification to the transmission source.
Off	Do not send a change notification to the transmission source.

- Use [F1] to display the ExtControl AUX Panel1 to 5 sub menu.

ExtControl AUX Panel1	IP Address1 0.0.0.0	IP Address2 0.0.0.0	IP Address3 0.0.0.0	IP Address4 0.0.0.0
ExtControl AUX Panel2	IP Address5 0.0.0.0	IP Address6 0.0.0.0	IP Address7 0.0.0.0	IP Address8 0.0.0.0
ExtControl AUX Panel3	IP Address9 0.0.0.0	IP Address10 0.0.0.0	IP Address11 0.0.0.0	IP Address12 0.0.0.0
ExtControl AUX Panel4	IP Address13 0.0.0.0	IP Address14 0.0.0.0	IP Address15 0.0.0.0	IP Address16 0.0.0.0
ExtControl AUX Panel5	IP Address17 0.0.0.0	IP Address18 0.0.0.0	IP Address19 0.0.0.0	IP Address20 0.0.0.0

- Press [F2] to [F5] to set the IP address of the connected external device.

- Use [F1] to display the ExtControl Aux Panel6 sub menu.



- Use [F2] to set the receiving port number of the connected external device. Set to 60031 when connecting to the Remote Camera Controller AW-RP series.

External interfaces

- ⑪ Information about the DMSG-CONTROL parameter of the TSL UMD Protocol V5.0 commands
TallyGroup1 settings are output when RH tally is output.
TallyGroup2 settings are output when TXT tally is output.
TallyGroup3 settings are output when LH tally is output.
- ⑫ When the material name on the control panel is to be changed
It is necessary to set the Type of each of the input source columns to User with <CONF/SYS> button → [SOURCE NAME] → [Panel Name] tab.
Similarly, when the material name on the multi view display is to be changed, it is necessary to set the Type of each of the input source columns to User with <CONF/SYS> button → [SOURCE NAME] → [MV Name] tab.
It is not possible to change the material names from an external source individually for each input source. This will be an overall change for the materials set in User.

<Command specifications>

Refer to the AV-UHS500 external interface communications protocol specifications.

Macro Trigger

<Overview>

By receiving specific commands via the TCP/IP protocol from external devices connected via the network, it is possible to execute macros that have been set. Use 63000 for the TCP/IP PORT number.

<Preparation>

Connect the external device that will apply the macro trigger via the network using a LAN cable to the LAN connector on the rear of AV-UHS500. 20 IP connections are supported. When connecting to multiple external devices, connect via a hub. Set IP address so there is no duplication.

<Settings>

- ① Press the  button to light its indicator, and display the System menu.
- ② Use [F1] to display the Macro Trigger Control1 sub menu.

Macro Trigger Control1	Disable/Enable	Disable	Enable				
------------------------	----------------	---------	--------	--	--	--	--

- ③ Press [F2] to enable/disable the Macro Trigger function in the Disable/Enable item.
- ④ Use [F1] to display the Macro Trigger Control2 to 11 sub menu.

Macro Trigger Control2	IP Address1 0.0.0.0	Macro1 No Assign	IP Address2 0.0.0.0	Macro2 No Assign
Macro Trigger Control3	IP Address3 0.0.0.0	Macro3 No Assign	IP Address4 0.0.0.0	Macro4 No Assign
Macro Trigger Control4	IP Address5 0.0.0.0	Macro5 No Assign	IP Address6 0.0.0.0	Macro6 No Assign
Macro Trigger Control5	IP Address7 0.0.0.0	Macro7 No Assign	IP Address8 0.0.0.0	Macro8 No Assign
Macro Trigger Control6	IP Address9 0.0.0.0	Macro9 No Assign	IP Address10 0.0.0.0	Macro10 No Assign
Macro Trigger Control7	IP Address11 0.0.0.0	Macro11 No Assign	IP Address12 0.0.0.0	Macro12 No Assign
Macro Trigger Control8	IP Address13 0.0.0.0	Macro13 No Assign	IP Address14 0.0.0.0	Macro14 No Assign
Macro Trigger Control9	IP Address15 0.0.0.0	Macro15 No Assign	IP Address16 0.0.0.0	Macro16 No Assign

- ⑤ Press [F2] and [F4] to set the IP address of the external device that will apply the macro trigger via the network in the IP Address item.
- ⑥ Press [F3] and [F5] to set the macro to be executed in the Macro item.
- ⑦ Register the macro to be executed on AV-UHS500. Refer to "Memory" for information about registering macros.

Appearance

Unit: mm (inch)

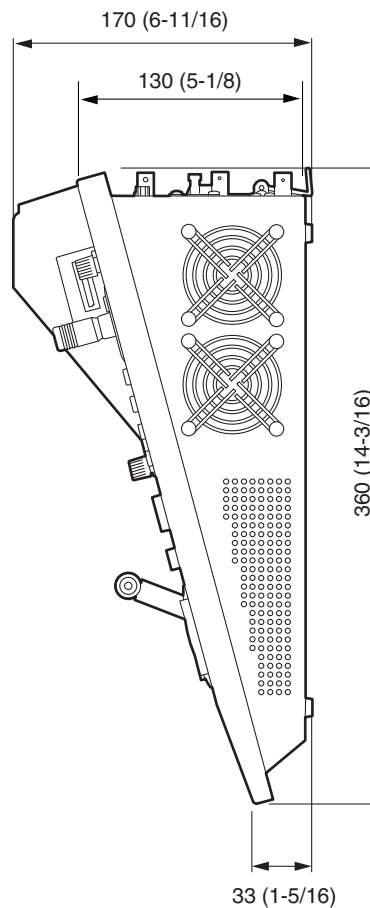
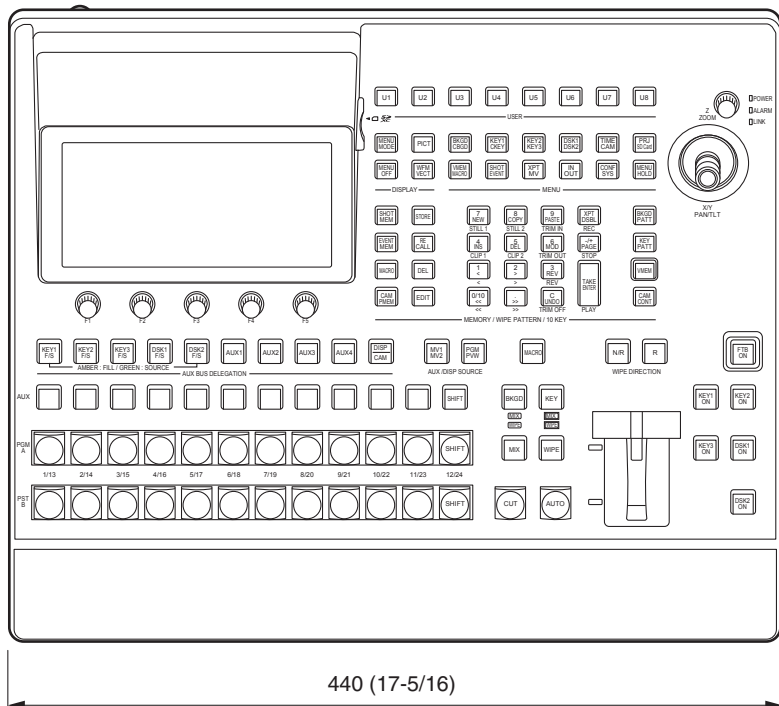
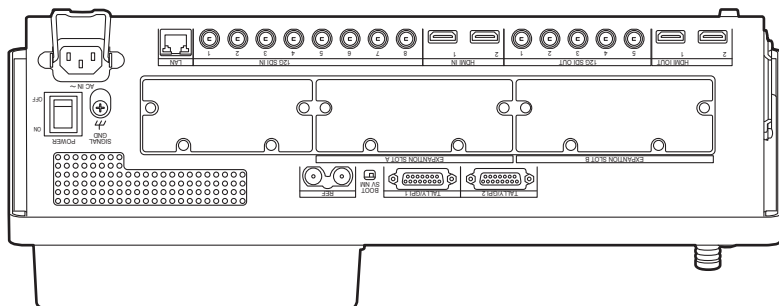

Specifications

Power supply: AC (∼) 100 V to 240 V, 50/60 Hz
Current consumption: 1.5 A

 indicates safety information.

Video connectors

<SDI IN 1> to <SDI IN 8> terminals	8 lines (plus another maximum of 8 lines when using the OPTION unit)	
	<ul style="list-style-type: none"> • Connectors: BNC × 8 • Connectors <SDI IN 5> to <SDI IN 8> equipped with up-converters. • Connectors <SDI IN 5> to <SDI IN 8> equipped with color correctors. • SDI IN 1/2 excludes HDMI IN 1/2. 	
	12G-SDI	12G-SDI, complied with SMPTE ST 2082-10 standard
	3G-SDI	3G-SDI, complied with SMPTE292 standard (Compatible with Level-A/Level-B)
	HD-SDI	HD-SDI, complied with SMPTE292M standard
<HDMI IN 1> to <HDMI IN 2> terminals	2 lines (plus another maximum of 6 lines when using the OPTION unit) Video format inputs: 720p/59.94 Hz, 720p/50 Hz, 1080i/59.94 Hz, 1080i/50 Hz, 1080p/59.94 Hz, 1080p/50 Hz, 1080p/29.97 Hz, 1080p/25 Hz, 1080p/24 Hz, 1080p/23.98 Hz, 2160p/59.94 Hz, 2160p/50 Hz, 2160p/29.97 Hz, 2160p/25 Hz, 2160p/24 Hz, 2160p/23.98 Hz, 720p/60 Hz, 1080i/60 Hz, 1080p/60 Hz, 2160p/60 Hz <ul style="list-style-type: none"> • Connectors: HDMI × 2 • This connector does not support the CPRM technologies. • HDMI IN 1/2 excludes SDI IN 1/2. 	
<SDI OUT 1> to <SDI OUT 5> terminals	5 lines (plus another maximum of 8 lines when using the OPTION unit)	
	<ul style="list-style-type: none"> • Connectors: BNC × 5 • PGM, PVW, CLN, ME PGM, MV1 to MV2, AUX1 to AUX4, Key Out can be assigned. 	
	12G-SDI	12G-SDI, complied with SMPTE ST 2082-10 standard
	3G-SDI	3G-SDI, complied with SMPTE292 standard (Compatible with Level-A)
	HD-SDI	HD-SDI, complied with SMPTE292M standard
<HDMI OUT 1> to <HDMI OUT 2> terminals	2 lines (plus another maximum of 6 lines when using the OPTION unit) Video format outputs: 720p/59.94 Hz, 720p/50 Hz, 1080i/59.94 Hz, 1080i/50 Hz, 1080p/59.94 Hz, 1080p/50 Hz, 1080p/29.97 Hz, 1080p/25 Hz, 1080p/24 Hz, 1080p/23.98 Hz, 2160p/59.94 Hz, 2160p/50 Hz, 2160p/29.97 Hz, 2160p/25 Hz, 2160p/24 Hz, 2160p/23.98 Hz, 720p/60 Hz, 1080i/60 Hz, 1080p/60 Hz, 2160p/60 Hz <ul style="list-style-type: none"> • Connectors :HDMI × 2 • PGM, PVW, CLN, ME PGM, MV1 to MV2, AUX1 to AUX4, Key Out can be assigned. 	
Signal formats	2160/59.94P, 50P, 29.97P, 25P, 24P, 23.98P, 1080/59.94P, 50P, 29.97Psf, 25Psf, 24Psf, 23.98Psf, 59.94i, 50i, 29.97p, 25p, 24p, 23.98p, 720/59.94P, 50P	
Signal processing	R: G: B	4: 4: 4 10 bit/4: 2: 2 10 bit
	Y: PB: PR	4: 2: 2 10 bit
ME number	1ME	

Specifications

Synchronizing connectors

<REF> terminal Reference input/ BB outputs	In Genlock mode: Black burst or Tri-level Sync input signals (with loop-through) <ul style="list-style-type: none"> • Loop-through output is performed in external sync mode. • If loop-through output is not going to be used, provide a 75 Ω termination. • Connectors : BNC • Same field frequencies as those of the system formats supported. • With the 1080/24PsF format, only Genlock mode supported. • With the 1080/23.98PsF format, black burst with 10 Field ID (SMPTE318M standard met) or Tri-level Sync signals supported. • BB signals are output from two connectors in the internal sync mode. 	
Video delay time	1 line (H)	When the frame synchronizer setting is [Off] and neither the up-converter nor the down-converter is operating
	1 frame (F)	When the frame synchronizer setting is on and the up-converter and down-converter are operating
	<ul style="list-style-type: none"> • When the signals have passed through PinP, DVE, multi view, down-converter or HDMI IN, a maximum delay of 1 frame is applied in each case. 	

Control connectors

<LAN> terminal	Compatible with 1000Base-TX and AUTO-MDIX (For IP control) <ul style="list-style-type: none"> • Connecting cable: LAN cable (CAT5E), max. 100 m (328 ft), STP (Shielded Twisted Pair) cable recommended • Connectors : RJ-45 	
<TALLY GPI> terminal	INPUT: 8 inputs, general-purpose, photocoupler sensing OUTPUT: 19 outputs, selected from R/G tally, general-purpose ALARM: 1 output, open collector output (negative logic)	

Other

Ambient operating temperature	0 °C to 40 °C (32 °F to 104 °F)
Ambient operating humidity	10% to 90% (no condensation)
Storage temperature	0 °C to 40 °C (32 °F to 104 °F)
Storage humidity	10% to 90% (no condensation)
Mass	Approx. 7 kg (15.4 lb)
Dimensions (W × H × D)	440 mm × 170 mm × 360 mm (17-5/16 inches × 6-11/16 inches × 14-3/16 inches) (excluding protrusions)

Setting menu table

- Settings for items indicated with (↓) are reflected when the item is selected and [F2], [F3], [F4] or [F5] is pressed.

Menu	Sub menu		Parameter 1	Parameter 2	Parameter 3	Parameter 4
	Use [F1] to select.		Use [F2] to select.	Use [F3] to select.	Use [F4] to select.	Use [F5] to select.
Background	Border	Parameter	Border	Width	Soft	
		Setting range	On, Off	0.1 to 100.0	0.0 to 100.0	
		Default value	Off	5.0	0.0	
	Border Color	Parameter	Hue	Sat	Lum	Load
		Setting range	0.0 to 359.9	0.0 to 100.0	0.0 to 108.0	White, Yellow, Cyan, Green, Magenta, Red, Blue, Black
		Default value	0.0	0.0	100.0	White
	Position	Parameter	X-Pos	Y-Pos		Copy To Key1
		Setting range	- 100.00 to 100.00	- 100.00 to 100.00		Execute
		Default value	0.00	0.00		
	Modify	Parameter	Trim			
		Setting range	Off, 16:9, 4:3, 4:3 Smooth			
		Default value	Off			
	3D Modify	Parameter	Light	Size	Radius	Angle
		Setting range	On, Off	0.0 to 100.0	0.000 to 1.000	- 45 to 45
		Default value	Off	100.0	0.500	0
	Transition Time	Parameter	TransTime	WaitTime	Wait	
		Setting range	0 to 999* (Frame)	0 to 999* (Frame)	Off, On	
		Default value	1s00f	0s00f	Off	
	Transition Margin	Parameter	Margin	Start	End	
		Setting range	Off, On	0.0 to 100.0	0.0 to 100.0	
	Default value	Off	0.0	0.0		
Clip Trans Sync	Parameter	Clip1	Clip2			
	Setting range	Off, AUTO, KEY1 ON, KEY2 ON, KEY3 ON, DSK1 ON, DSK2 ON, FTB ON, Fader	Off, AUTO, KEY1 ON, KEY2 ON, KEY3 ON, DSK1 ON, DSK2 ON, FTB ON, Fader			
	Default value	Off	Off			

*: Items with frame count indications will in fact be displayed with the time corresponding to the Format.

Setting menu table

Menu	Sub menu		Parameter 1	Parameter 2	Parameter 3	Parameter 4
	Use [F1] to select.		Use [F2] to select.	Use [F3] to select.	Use [F4] to select.	Use [F5] to select.
Color Background	CBGD1 Main	Parameter	Hue	Sat	Lum	Load
		Setting range	0.0 to 359.9	0.0 to 100.0	0.0 to 108.0	White, Yellow, Cyan, Green, Magenta, Red, Blue, Black
		Default value	120.0	100.0	100.0	Blue
	CBGD1 Sub	Parameter	Hue	Sat	Lum	Load
		Setting range	0.0 to 359.9	0.0 to 100.0	0.0 to 108.0	White, Yellow, Cyan, Green, Magenta, Red, Blue, Black
		Default value	0.0	0.0	100.0	White
	CBGD1 Wash	Parameter	Wash	Color	R-Sat	R-Lum
		Setting range	On, Off	Dual, Rainbow	0.0 to 100.0	0.0 to 108.0
		Default value	Off	Dual	100.0	100.0
	CBGD1 Wave	Parameter	Pattern	Cycle	Phase	Angle
		Setting range	Sine, Saw	0 to 100	- 180.0 to 180.0	0.0 to 360.0
		Default value	Sine	0	0.0	0.0
	CBGD1 Move	Parameter	Move	Speed		
		Setting range	Off, Roll, Rotation	- 50.0 to 50.0		
		Default value	Off	1.0		
	CBGD2 Main	Parameter	Hue	Sat	Lum	Load
		Setting range	0.0 to 359.9	0.0 to 100.0	0.0 to 108.0	White, Yellow, Cyan, Green, Magenta, Red, Blue, Black
		Default value	0.0	100.0	100.0	Red
	CBGD2 Sub	Parameter	Hue	Sat	Lum	Load
		Setting range	0.0 to 359.9	0.0 to 100.0	0.0 to 108.0	White, Yellow, Cyan, Green, Magenta, Red, Blue, Black
		Default value	0.0	0.0	100.0	White
	CBGD2 Wash	Parameter	Wash	Color	R-Sat	R-Lum
		Setting range	On, Off	Dual, Rainbow	0.0 to 100.0	0.0 to 108.0
		Default value	Off	Dual	100.0	100.0
	CBGD2 Wave	Parameter	Pattern	Cycle	Phase	Angle
		Setting range	Sine, Saw	0 to 100	- 180.0 to 180.0	0.0 to 360.0
		Default value	Sine	0	0.0	0.0
	CBGD2 Move	Parameter	Move	Speed		
	Setting range	Off, Roll, Rotation	- 50.0 to 50.0			
	Default value	Off	1.0			

Setting menu table

Menu	Sub menu		Parameter 1	Parameter 2	Parameter 3	Parameter 4
	Use [F1] to select.		Use [F2] to select.	Use [F3] to select.	Use [F4] to select.	Use [F5] to select.
Key1	Key	Parameter	Type	Lum Key	Fill	PVW
		Setting range	Lum, Linear, Chroma, Full	Chroma On, Chroma Off	Bus, Matte	Auto, Off, On
		Default value	Linear	Chroma Off	Bus	Auto
	Adjust	Parameter	Clip	Gain	Density	Invert
		Setting range	0.0 to 108.0	0.0 to 200.0	0.0 to 100.0	On, Off
		Default value	0.0	100.0	100.0	Off
	Fill Matte	Parameter	Hue	Sat	Lum	Load
		Setting range	0.0 to 359.9	0.0 to 100.0	0.0 to 108.0	White, Yellow, Cyan, Green, Magenta, Red, Blue, Black
		Default value	0.0	0.0	100.0	White
	Edge1	Parameter	Type	Width	Direction	Density
		Setting range	Off, Border, Drop, Shadow, Outline	0 to 4	0, 45, 90, 135, 180, 225, 270, 315	25%, 50%, 75%, 100%
		Default value	Off	2	0	100%
	Edge2	Parameter	Edge Fill			
		Setting range	Color, CBGD1, CBGD2, Still1, Still2, Clip1, Clip2			
		Default value	Color			
	Edge Color	Parameter	Hue	Sat	Lum	Load
		Setting range	0.0 to 359.9	0.0 to 100.0	0.0 to 108.0	White, Yellow, Cyan, Green, Magenta, Red, Blue, Black
		Default value	0.0	0.0	0.0	Black
	Transition	Parameter	Keyout Pattern			
		Setting range	Normal, Reverse			
		Default value	Normal			
	Position	Parameter	X-Pos	Y-Pos		Copy To BKGD
		Setting range	- 100.00 to 100.00	- 100.00 to 100.00		Execute
		Default value	0.00	0.00		
	Flying Key Rotation/Size	Parameter	X-Pos	Y-Pos	Size	
		Setting range	- 100.00 to 100.00	- 100.00 to 100.00	0.0 to 400.0	
		Default value	0.00	0.00	100.0	
	Flying Key Rotation	Parameter	X	Y	Z	
		Setting range	- 2880.0 to 2880.0	- 2880.0 to 2880.0	- 2880.0 to 2880.0	
		Default value	0.0	0.0	0.0	
	Flying Key Aspect	Parameter	X	Y		
		Setting range	50.00 to 100.00	50.00 to 100.00		
		Default value	100.00	100.00		
3D Modify	Parameter	Light	Size	Radius	Angle	
	Setting range	On, Off	0.0 to 100.0	0.000 to 1.000	- 45 to 45	
	Default value	Off	100.0	0.500	0	

Setting menu table

Menu	Sub menu		Parameter 1	Parameter 2	Parameter 3	Parameter 4
	Use [F1] to select.		Use [F2] to select.	Use [F3] to select.	Use [F4] to select.	Use [F5] to select.
Key1	Mask	Parameter	Mask	Invert		
		Setting range	Off, Manual, 4:3	On, Off		
		Default value	Off	Off		
	Mask Adjust	Parameter	Left	Top	Bottom	Right
		Setting range	- 50.00 to 50.00	- 50.00 to 50.00	- 50.00 to 50.00	- 50.00 to 50.00
		Default value	- 25.00	25.00	- 25.00	25.00
	PinP	Parameter	PinP	Full Key	Shape	Density
		Setting range	On, Off	On, Off	Square, Circle, Heart, Flower, Star	0.0 to 100.0
		Default value	Off	On	Square	100.0
	PinP Border	Parameter	Border	Width	Soft	Mode
		Setting range	On, Off	0.1 to 100.0	0.0 to 100.0	Fix, Variable
		Default value	Off	5.0	0.0	Fix
	PinP Position	Parameter	X-Pos	Y-Pos	Size	
		Setting range	- 100.00 to 100.00	- 100.00 to 100.00	0.0 to 100.0	
		Default value	0.00	0.00	25.0	
	PinP Trim	Parameter	Trim	Pair	Preset	
		Setting range	Off, On (Disabled when set to anything other than Square)	On, Off	16:9, 12:9, 9:9, 7:9, 6:9, Manual	
		Default value	Off	Off	16:9	
	PinP Trim Adjust	Parameter	Left	Top	Bottom	Right
		Setting range	- 50.00 to 50.00	- 50.00 to 50.00	- 50.00 to 50.00	- 50.00 to 50.00
		Default value	- 50.00	50.00	- 50.00	50.00
	PinP Sync	Parameter	Symmetry			Copy To DSK1
		Setting range	Off, X, Y, Center, Same			Execute
		Default value	Off			
	Key Signal Coupling	Parameter	Independent			
		Setting range	On, Off			
		Default value	Off			
	Key Priority	Parameter	Key1	Key2	Key3	
		Setting range	1st, 2nd, 3rd	1st, 2nd, 3rd	1st, 2nd, 3rd	
		Default value	3rd	2nd	1st	
	Key On	Parameter	Key1			
		Setting range	On, Off			
		Default value	Off			

Setting menu table

Menu	Sub menu		Parameter 1	Parameter 2	Parameter 3	Parameter 4
	Use [F1] to select.		Use [F2] to select.	Use [F3] to select.	Use [F4] to select.	Use [F5] to select.
Key2	Key	Parameter	Type	Lum Key	Fill	PVW
		Setting range	Lum, Linear, Full	Chroma On, Chroma Off	Bus, Matte	Off, On
		Default value	Linear	Chroma Off	Bus	Off
	Adjust	Parameter	Clip	Gain	Density	Invert
		Setting range	0.0 to 108.0	0.0 to 200.0	0.0 to 100.0	On, Off
		Default value	0.0	100.0	100.0	Off
	Fill Matte	Parameter	Hue	Sat	Lum	Load
		Setting range	0.0 to 359.9	0.0 to 100.0	0.0 to 108.0	White, Yellow, Cyan, Green, Magenta, Red, Blue, Black
		Default value	0.0	0.0	100.0	White
	Edge1	Parameter	Type	Width	Direction	Density
		Setting range	Off, Border, Drop, Shadow, Outline	0 to 4	0, 45, 90, 135, 180, 225, 270, 315	25%, 50%, 75%, 100%
		Default value	Off	2	0	100%
	Edge2	Parameter	Edge Fill			
		Setting range	Color, CBGD1, CBGD2, Still1, Still2, Clip1, Clip2			
		Default value	Color			
	Edge Color	Parameter	Hue	Sat	Lum	Load
		Setting range	0.0 to 359.9	0.0 to 100.0	0.0 to 108.0	White, Yellow, Cyan, Green, Magenta, Red, Blue, Black
		Default value	0.0	0.0	100.0	Black
	Mask	Parameter	Mask	Invert		
		Setting range	Off, Manual, 4:3	On, Off		
		Default value	Off	Off		
	Mask Adjust	Parameter	Left	Top	Bottom	Right
		Setting range	- 50.00 to 50.00	- 50.00 to 50.00	- 50.00 to 50.00	- 50.00 to 50.00
		Default value	- 25.00	25.00	- 25.00	25.00
	PinP	Parameter	PinP	Full Key	Shape	Density
		Setting range	On, Off	On, Off	Square, Circle, Heart, Flower, Star	0.0 to 100.0
		Default value	Off	On	Square	100.0
	PinP Border	Parameter	Border	Width	Soft	Mode
		Setting range	Off, On	0.1 to 100.0	0.0 to 100.0	Fix, Variable
		Default value	Off	5.0	0.0	Fix
PinP Position	Parameter	X-Pos	Y-Pos	Size		
	Setting range	- 100.00 to 100.00	- 100.00 to 100.00	0.00 to 100.00		
	Default value	0.00	0.00	25.00		

Setting menu table

Menu	Sub menu		Parameter 1	Parameter 2	Parameter 3	Parameter 4
	Use [F1] to select.		Use [F2] to select.	Use [F3] to select.	Use [F4] to select.	Use [F5] to select.
Key2	PinP Trim	Parameter	Trim	Pair	Preset	
		Setting range	Off, On (Disabled when set to anything other than Square)	Off, On	16:9, 12:9, 9:9, 7:9, 6:9, Manual	
		Default value	Off	Off	16:9	
	PinP Trim Adjust	Parameter	Left	Top	Bottom	Right
		Setting range	- 50.00 to 50.00	- 50.00 to 50.00	- 50.00 to 50.00	- 50.00 to 50.00
		Default value	- 40.00	40.00	- 40.00	40.00
	PinP Sync	Parameter	Symmetry			Copy To DSK1
		Setting range	Off, X, Y, Center, Same			Execute
		Default value	Off			
	Key Signal Coupling	Parameter	Independent			
		Setting range	On, Off			
		Default value	Off			
	Key Priority	Parameter	Key1	Key2	Key3	
		Setting range	1st, 2nd, 3rd	1st, 2nd, 3rd	1st, 2nd, 3rd	
		Default value	3rd	2nd	1st	
	Key On	Parameter	Key2			
	Setting range	On, Off				
	Default value	Off				
Key3	Key	Parameter	Type	Lum Key	Fill	PVW
		Setting range	Lum, Linear, Full	Chroma On, Chroma Off	Bus, Matte	Off, On
		Default value	Linear	Chroma Off	Bus	Off
	Adjust	Parameter	Clip	Gain	Density	Invert
		Setting range	0.0 to 108.0	0.0 to 200.0	0.0 to 100.0	On, Off
		Default value	0.0	100.0	100.0	Off
	Fill Matte	Parameter	Hue	Sat	Lum	Load
		Setting range	0.0 to 359.9	0.0 to 100.0	0.0 to 108.0	White, Yellow, Cyan, Green, Magenta, Red, Blue, Black
		Default value	0.0	0.0	100.0	White
	Mask	Parameter	Mask	Invert		
		Setting range	Off, Manual, 4:3	On, Off		
		Default value	Off	Off		
	Mask Adjust	Parameter	Left	Top	Bottom	Right
		Setting range	- 50.00 to 50.00	- 50.00 to 50.00	- 50.00 to 50.00	- 50.00 to 50.00
		Default value	- 25.00	25.00	- 25.00	25.00
	Key Signal Coupling	Parameter	Independent			
	Setting range	On, Off				
	Default value	Off				
Key Priority	Parameter	Key1	Key2	Key3		
	Setting range	1st, 2nd, 3rd	1st, 2nd, 3rd	1st, 2nd, 3rd		
	Default value	3rd	2nd	1st		
Key On	Parameter	Key2				
	Setting range	On, Off				
	Default value	Off				

Setting menu table

Menu	Sub menu		Parameter 1	Parameter 2	Parameter 3	Parameter 4
	Use [F1] to select.		Use [F2] to select.	Use [F3] to select.	Use [F4] to select.	Use [F5] to select.
Chroma Key	Chroma Key	Parameter	Select	Key Type		
		Setting range	Key1, DSK1	Linked to the Key Type of Key1 or DSK selected in Select		
		Default value	Key1			
	Auto Compute	Parameter	Auto Compute			Reset
		Setting range	Execute			Execute
		Default value				
	Adjust	Parameter	Narrow	Phase		
		Setting range	Off, 0.5, 1.0, 1.5	- 4.0 to 4.0		
		Default value	Off	0.0		
	Sampling	Parameter	View	Mode	Sampling	Undo
		Setting range	Composite, Matte, Proc FG, FG	Select BG, Clean BG, Clean FG, Sponge, Fine Tuning	Execute	Execute
		Default value	Composite	Select BG Color		
	Sampling Area	Parameter	X-Pos	Y-Pos	Size	
		Setting range	- 50.00 to 50.00	- 50.00 to 50.00	1.00 to 100.00	
		Default value	0.00	0.00	10.00	
	Fine Tuning	Parameter	Spill	Trans	Detail	
		Setting range	- 1000 to 1000	- 1000 to 1000	- 1000 to 1000	
		Default value	0	0	0	
	Adjusting Mode	Parameter	Adjusting Mode			
		Setting range	Sample Mode, Value Mode			
	Default value	Sample Mode				
Value	Parameter	ColorCancel	FG Trans	BG Clean		
	Setting range	- 100.00 to 100.00	- 100.00 to 100.00	- 100.00 to 100.00		
	Default value	0.00	0.00	0.00		
DSK1	DSK	Parameter	Type	Lum Key	Fill	PVW
		Setting range	Lum, Linear, Chroma, Full	Chroma On, Chroma Off	Bus, Matte	Off, On
		Default value	Linear	Chroma Off	Bus	Off
	Adjust	Parameter	Clip	Gain	Density	Invert
		Setting range	0.0 to 108.0	0.0 to 200.0	0.0 to 100.0	On, Off
		Default value	0.0	100.0	100.0	Off
	Fill Matte	Parameter	Hue	Sat	Lum	Load
	Setting range	0.0 to 359.9	0.0 to 100.0	0.0 to 108.0	White, Yellow, Cyan, Green, Magenta, Red, Blue, Black	
	Default value	0.0	0.0	100.0	White	

Setting menu table

Menu	Sub menu		Parameter 1	Parameter 2	Parameter 3	Parameter 4
	Use [F1] to select.		Use [F2] to select.	Use [F3] to select.	Use [F4] to select.	Use [F5] to select.
DSK1	Mask	Parameter	Mask	Invert		
		Setting range	Off, Manual, 4:3	On, Off		
		Default value	Off	Off		
	Mask Adjust	Parameter	Left	Top	Bottom	Right
		Setting range	- 50.00 to 50.00	- 50.00 to 50.00	- 50.00 to 50.00	- 50.00 to 50.00
		Default value	- 25.00	25.00	- 25.00	25.00
	PinP	Parameter	PinP	Full Key	Shape	Density
		Setting range	On, Off	On, Off	Square, Circle, Heart, Flower, Star	0.0 to 100.0
		Default value	Off	On	Square	100.0
	PinP Border	Parameter	Border	Width	Soft	Mode
		Setting range	Off, On	0.1 to 100.0	0.0 to 100.0	Fix, Variable
		Default value	Off	5.0	0.0	Fix
	PinP Position	Parameter	X-Pos	Y-Pos	Size	
		Setting range	- 100.0 to 100.0	- 100.0 to 100.0	0.0 to 100.0	
		Default value	0.00	0.00	25.0	
	PinP Trim	Parameter	Trim	Pair	Preset	
		Setting range	Off, On (Disabled when set to anything other than Square)	Off, On	16:9, 12:9, 9:9, 7:9, 6:9, Manual	
		Default value	Off	Off	16:9	
	PinP Trim Adjust	Parameter	Left	Top	Bottom	Right
		Setting range	- 50.00 to 50.00	- 50.00 to 50.00	- 50.00 to 50.00	- 50.00 to 50.00
		Default value	- 50.00	50.00	- 50.00	50.00
	PinP Sync	Parameter	Symmetry			Copy To Key2
		Setting range	Off, X, Y, Center, Same			Execute
		Default value	Off			
	DSK Priority	Parameter	DSK1	DSK2		
		Setting range	1st, 2nd	1st, 2nd		
		Default value	2nd	1st		
	DSK Signal Coupling	Parameter	Independent			
	Setting range	On, Off				
	Default value	Off				
DSK On	Parameter	DSK1				
	Setting range	On, Off				
	Default value	Off				

Setting menu table

Menu	Sub menu		Parameter 1	Parameter 2	Parameter 3	Parameter 4
	Use [F1] to select.		Use [F2] to select.	Use [F3] to select.	Use [F4] to select.	Use [F5] to select.
DSK2	DSK	Parameter	Type	Lum Key	Fill	PVW
		Setting range	Lum, Linear, Full	Chroma On, Chroma Off	Bus, Matte	Off, On
		Default value	Linear	Chroma Off	Bus	Off
	Adjust	Parameter	Clip	Gain	Density	Invert
		Setting range	0.0 to 108.0	0.0 to 200.0	0.0 to 100.0	On, Off
		Default value	0.0	100.0	100.0	Off
	Fill Matte	Parameter	Hue	Sat	Lum	Load
		Setting range	0.0 to 359.9	0.0 to 100.0	0.0 to 108.0	White, Yellow, Cyan, Green, Magenta, Red, Blue, Black
		Default value	0.0	0.0	100.0	White
	Mask	Parameter	Mask	Invert		
		Setting range	Off, Manual, 4:3	On, Off		
		Default value	Off	Off		
	Mask Adjust	Parameter	Left	Top	Bottom	Right
		Setting range	- 50.00 to 50.00	- 50.00 to 50.00	- 50.00 to 50.00	- 50.00 to 50.00
		Default value	- 25.00	25.00	- 25.00	25.00
	DSK Priority	Parameter	DSK1	DSK2		
		Setting range	1st, 2nd	1st, 2nd		
		Default value	2nd	1st		
	DSK Signal Coupling	Parameter	Independent			
		Setting range	On, Off			
		Default value	Off			
	DSK On	Parameter	DSK2			
		Setting range	On, Off			
		Default value	Off			

Setting menu table

Menu	Sub menu		Parameter 1	Parameter 2	Parameter 3	Parameter 4
	Use [F1] to select.		Use [F2] to select.	Use [F3] to select.	Use [F4] to select.	Use [F5] to select.
Time	BKGD	Parameter	TransTime	WaitTime	Wait	
		Setting range	0 to 999* (Frame)	0 to 999* (Frame)	Off, On	
		Default value	1s00f	1s00f	Off	
	Key1	Parameter	TransTime			
		Setting range	0 to 999* (Frame)			
		Default value	1s00f			
	Key2	Parameter	TransTime			
		Setting range	0 to 999* (Frame)			
		Default value	1s00f			
	Key3	Parameter	TransTime			
		Setting range	0 to 999* (Frame)			
		Default value	1s00f			
	DSK1	Parameter	TransTime			
		Setting range	0 to 999* (Frame)			
		Default value	1s00f			
	DSK2	Parameter	TransTime			
		Setting range	0 to 999* (Frame)			
		Default value	1s00f			
	AUX1 BUS Trans	Parameter	TransTime	Transition		
		Setting range	0 to 999* (Frame)	On, Off		
		Default value	1s00f	Off		
	AUX2 BUS Trans	Parameter	TransTime	Transition		
		Setting range	0 to 999* (Frame)	On, Off		
		Default value	1s00f	Off		
	Effect Dissolve	Parameter	TransTime			
		Setting range	0 to 999* (Frame)			
		Default value	1s00f			
	FTB	Parameter	TransTime			
		Setting range	0 to 999* (Frame)			
		Default value	1s00f			

*: Items with frame count indications will in fact be displayed with the time corresponding to the Format.

Setting menu table

Menu	Sub menu		Parameter 1	Parameter 2	Parameter 3	Parameter 4	
	Use [F1] to select.		Use [F2] to select.	Use [F3] to select.	Use [F4] to select.	Use [F5] to select.	
Camera	Camera Information	Parameter	Input Selection	Name	Model	Status	
		Setting range	*1	*2	Model name of the camera “-” is displayed if no camera is connected.	*3	
		Default value	IN1	-	-	No IP Address	
	Camera Control	Parameter	Power	All Power On	All Standby	Z-Dial Usage	
		Setting range	Standby, On	Execute	Execute	P-T Sp. & Zoom, P-T Speed Only	
		Default value	Undetermined (depends on the settings on the camera)			P-T Sp. & Zoom	
	Control Speed	Parameter	Pan & Tilt	Zoom	Focus	Iris	
		Setting range	1 to 32	1 to 32	1 to 32	1 to 32	
		Default value	16	16	16	16	
	OSD Menu & Color Bars	Parameter	OSD Menu	Menu Operation	Color Bars		
		Setting range	On, Off	(Turn or Push)	On, Off		
		Default value	Undetermined (depends on the settings on the camera)		Undetermined (depends on the settings on the camera)		
	Lens Control	Parameter	Auto Focus	Auto Iris			
		Setting range	On, Off	On, Off			
		Default value	Undetermined (depends on the settings on the camera)	Undetermined (depends on the settings on the camera)			
	AWB	Parameter	AWB	Last AWB Result	AWB Mode		
		Setting range	Execute	-, Successful, Failed	ATW, AWB A, AWB B, 3200K, 5600K, VAR		
		Default value		-	Undetermined (depends on the settings on the camera)		
	<p>*1: IN1, IN2, SDI IN3, SDI IN4, SDI IN5, SDI IN6, SDI IN7, SDI IN8, HDMI IN1, HDMI IN2, SlotA HDMI IN board is inserted: IN-A1, IN-A2, IN-A3, SlotA SDI IN board is inserted: IN-A1, IN-A2, IN-A3, IN-A4, SlotB HDMI IN board is inserted: IN-B1, IN-B2, IN-B3 SlotB SDI IN board is inserted: IN-B1, IN-B2, IN-B3, IN-B4</p> <p>*2: Name registered on the camera. When a camera is not connected, “-” is displayed. When the camera name is just a single space, “(Standby Mode)” is displayed.</p> <p>*3: No IP Address, Now Checking..., Connected, Unauthorized, Not Connected, Please Wait..., Pan & Tilt Alarm, Fan Alarm, Other Alarm</p>						

Setting menu table

Menu	Sub menu		Parameter 1	Parameter 2	Parameter 3	Parameter 4	
	Use [F1] to select.		Use [F2] to select.	Use [F3] to select.	Use [F4] to select.	Use [F5] to select.	
Camera	ABB	Parameter	ABB	Last ABB Result			
		Setting range	Execute	- , Successful, Failed			
		Default value		-			
	Gain1	Parameter	Gain	R Gain	B Gain		
		Setting range	*1	*2			
		Default value	Undetermined (depends on the settings on the camera)	Undetermined (depends on the settings on the camera)	Undetermined (depends on the settings on the camera)		
	Gain2	Parameter	AGC Max Gain	Super Gain			
		Setting range	*3	ON, OFF			
		Default value	Undetermined (depends on the settings on the camera)	Undetermined (depends on the settings on the camera)			
	Pedestal	Parameter	M Ped.	R Ped.	G Ped.	B Ped.	
		Setting range	*4	- 100 to 100	- 100 to 100	- 100 to 100	
		Default value	Undetermined (depends on the settings on the camera)	Undetermined (depends on the settings on the camera)	Undetermined (depends on the settings on the camera)	Undetermined (depends on the settings on the camera)	
	Preset Settings	Parameter	Preset Scope	Speed	Preset Sp. Unit	Preset Sp.Table	
		Setting range	Mode A, Mode B, Mode C	*5	Speed Table, Time	Slow, Fast	
		Default value	Undetermined (depends on the settings on the camera)	Undetermined (depends on the settings on the camera)	Undetermined (depends on the settings on the camera)	Undetermined (depends on the settings on the camera)	
	Lock	Parameter	Pan & Tilt Lock	Zoom Lock	Focus Lock	Iris Lock	
		Setting range	On, Off	On, Off	On, Off	On, Off	
		Default value	Off	Off	Off	Off	
	<p>*1: AW-UE100/AW-UE150/AW-HR140: 0 to 42 dB, AGC (Super Gain: ON), 0 to 36 dB, AGC (Super Gain: OFF) AW-HE130/AW-HN130: 0 to 36 dB, AGC AW-UE70/AW-UN70/AW-HE40/AW-HN40/AW-HE42: 0, 3, ..., 48 dB (3 dB increments), AGC</p> <p>*2: AW-UE100/AW-UE150: -200 to 200 AW-HR140/AW-HE130/AW-HN130: -150 to 150 AW-UE70/AW-UN70/AW-HE40/AW-HN40/AW-HE42: -30 to 30</p> <p>*3: AW-UE100/AW-UE150: -200 to 200 AW-HR140/AW-HE130/AW-HN130: -150 to 150 AW-UE70/AW-UN70/AW-HE40/AW-HN40/AW-HE42: -10 to 10</p> <p>*4: AW-UE100/AW-UE150/AW-HR140/AW-HE130/AW-HN130: 6 dB, 12 dB, 18 dB AW-UE70/AW-UN70/AW-HE40/AW-HN40/AW-HE42: 6 dB, 12 dB, 18 dB, 24 dB, 30 dB, 36 dB, 42 dB, 48 dB</p> <p>*5: AW-UE100/AW-UE150: 1 to 30 (Preset Sp.Unit: Speed Table) 1 to 99 (Preset Sp.Unit: Time) Other than AW-UE100/AW-UE150: 1 to 30</p>						

Setting menu table

Menu	Sub menu		Parameter 1	Parameter 2	Parameter 3	Parameter 4
	Use [F1] to select.		Use [F2] to select.	Use [F3] to select.	Use [F4] to select.	Use [F5] to select.
Project File	Last Load File	Parameter	Media	File Name		
		Setting range				
		Default value	Display only	Display only		
	Last Load Date	Parameter		Date		
		Setting range				
		Default value		Display only		
	Project File	Parameter	Load	Save	Delete	Rename
		Setting range	Execute	Execute	Execute	Execute
		Default value				
	Target Select1	Parameter	Setup	Shot	Event	Macro
		Setting range	On, Off	On, Off	On, Off	On, Off
		Default value	On	On	On	On
	Target Select2	Parameter	Still	Still Playlist	Clip	
		Setting range	On, Off	On, Off	On, Off	
	Default value	Off	Off	Off		
SD Card	Card Management	Parameter	Mount	Unmount		Format
		Setting range	Execute	Execute		Execute
		Default value				
	Mode	Parameter	Load	Delete	Rename	Sort
		Setting range	Execute	Execute	Execute	Newest, Oldest, Name
		Default value				Name
	File	Parameter	Save	Save Type	Format	
		Setting range	Execute	Still1, Still2, Clip1, Clip2, Project, Log	bmp, tga, png, jpeg, tif, gif	
		Default value		Project	png	
	Target Select1	Parameter	Setup	Shot	Event	Macro
		Setting range	On, Off	On, Off	On, Off	On, Off
		Default value	On	On	On	On
	Target Select2	Parameter	Still	Clip		
		Setting range	On, Off	On, Off		
	Default value	Off	Off			
Create Thumbnail	Parameter	Still	Clip			
	Setting range	Execute	Execute			
	Default value					
Card Information	Parameter	Free	Total			
	Setting range					
	Default value					

Setting menu table

Menu	Sub menu		Parameter 1	Parameter 2	Parameter 3	Parameter 4
	Use [F1] to select.		Use [F2] to select.	Use [F3] to select.	Use [F4] to select.	Use [F5] to select.
Video Memory When Still1, Still2	Video Memory1	Parameter	Select	Rec	Key	
		Setting range	Still1, Still2, Clip1, Clip2	Execute	On, Off	
		Default value	Still1			
	Rec1	Parameter	VMEM Video	VMEM Key		
		Setting range	AUX1 to 4	AUX1 to 4		
		Default value	AUX1	AUX1		
	Rec2	Parameter	Preview	Key Enable	Review	
		Setting range	On, Off	On, Off	On, Off	
		Default value	Off	On	On	
	Memory	Parameter	Mode	Select		Save
	Setting range	Auto, Manual	Still1, Still2, Clip1, Clip2, All		Execute	
	Default value	Auto	All			
Video Memory When Clip1, Clip2	Video Memory1	Parameter	Select	Rec	Play	Stop
		Setting range	Still1, Still2, Clip1, Clip2	Execute	Execute	Execute
		Default value	Still1			
	Video Memory2	Parameter	LEAD	LAST		
		Setting range	Execute	Execute		
		Default value				
	Video Memory3	Parameter	Total Time	Current Time	Key	
		Setting range	The setting range differs with each format.		On, Off	
		Default value				
	Rec1	Parameter	VMEM Video	VMEM Key		
		Setting range	AUX1 to 4	AUX1 to 4		
		Default value	AUX1	AUX1		
	Rec2	Parameter	Preview	Key Enable	Review	
		Setting range	On, Off	On, Off	On, Off	
		Default value	Off	On	On	
	Rec3	Parameter	Loop	Quality	Audio	
		Setting range	On, Off	High, Standard	On, Off	
		Default value	Off	Standard	On	
	Limit Time	Parameter	Mode			
		Setting range	1f to 2m00s00f (when 59.94i)			
		Default value	5s00f			
	Play Mode1	Parameter	Mode	Reverse	Variable	Freeze
	Setting range	Lead, Last, Loop	On, Off	x1, x2, x4, x8, x1/2, x1/4, x1/8	Frame, Field	
	Default value	Last	Off	x1	Frame	
Play Mode2	Parameter	Trans Sync		Audio		
	Setting range	Off, Auto, KEY1 ON, KEY2 ON, KEY3 ON, DSK1 ON, DSK2 ON, FTB ON, Fader		On, Off		
	Default value	Off		On		
Memory	Parameter	Mode	Select		Save	
	Setting range	Auto, Manual	Still1, Still2, Clip1, Clip2, All		Execute	
	Default value	Auto	All			

Setting menu table

Menu	Sub menu		Parameter 1	Parameter 2	Parameter 3	Parameter 4
	Use [F1] to select.		Use [F2] to select.	Use [F3] to select.	Use [F4] to select.	Use [F5] to select.
Macro	Store Select1	Parameter	ME	DSK	AUX	
		Setting range	On, Off	On, Off	On, Off	
		Default value	On	On	On	
	Store Select2	Parameter	MENU	XPT	OTHER	
		Setting range	On, Off	On, Off	On, Off	
		Default value	On	On	On	
	Insert Delay	Parameter	Time	Set		
		Setting range	0 to 600* (Frame)	Execute		
		Default value	1s00f			
	Macro Assign 1/6	Parameter	XPT1	XPT2	XPT3	XPT4
		Setting range	Macro001 to Macro100, PlayCancel, No Assign	Macro001 to Macro100, PlayCancel, No Assign	Macro001 to Macro100, PlayCancel, No Assign	Macro001 to Macro100, PlayCancel, No Assign
		Default value	No Assign	No Assign	No Assign	No Assign
	Macro Assign 2/6	Parameter	XPT5	XPT6	XPT7	XPT8
		Setting range	Macro001 to Macro100, PlayCancel, No Assign	Macro001 to Macro100, PlayCancel, No Assign	Macro001 to Macro100, PlayCancel, No Assign	Macro001 to Macro100, PlayCancel, No Assign
		Default value	No Assign	No Assign	No Assign	No Assign
	Macro Assign 3/6	Parameter	XPT9	XPT10	XPT11	XPT12
		Setting range	Macro001 to Macro100, PlayCancel, No Assign	Macro001 to Macro100, PlayCancel, No Assign	Macro001 to Macro100, PlayCancel, No Assign	Macro001 to Macro100, PlayCancel, No Assign
		Default value	No Assign	No Assign	No Assign	No Assign
	Macro Assign 4/6	Parameter	XPT13	XPT14	XPT15	XPT16
		Setting range	Macro001 to Macro100, PlayCancel, No Assign	Macro001 to Macro100, PlayCancel, No Assign	Macro001 to Macro100, PlayCancel, No Assign	Macro001 to Macro100, PlayCancel, No Assign
		Default value	No Assign	No Assign	No Assign	No Assign
	Macro Assign 5/6	Parameter	XPT17	XPT18	XPT19	XPT20
		Setting range	Macro001 to Macro100, PlayCancel, No Assign	Macro001 to Macro100, PlayCancel, No Assign	Macro001 to Macro100, PlayCancel, No Assign	Macro001 to Macro100, PlayCancel, No Assign
		Default value	No Assign	No Assign	No Assign	No Assign
Macro Assign 6/6	Parameter	XPT21	XPT22	XPT23	XPT24	
	Setting range	Macro001 to Macro100, PlayCancel, No Assign	Macro001 to Macro100, PlayCancel, No Assign	Macro001 to Macro100, PlayCancel, No Assign	Macro001 to Macro100, PlayCancel, No Assign	
	Default value	No Assign	No Assign	No Assign	No Assign	

*: Items with frame count indications will in fact be displayed with the time corresponding to the Format.

Setting menu table

Menu	Sub menu		Parameter 1	Parameter 2	Parameter 3	Parameter 4
	Use [F1] to select.		Use [F2] to select.	Use [F3] to select.	Use [F4] to select.	Use [F5] to select.
Macro	Register	Parameter	Page	No.	Rename	
		Setting range	1 to 10	1 to 10	Execute	
		Default value	1	1		
	Attach	Parameter	Enable	Attach Setting		
		Setting range	Off, On	Execute		
		Default value	Off			
Shot Memory	Target Select1	Parameter	ME	DSK	AUX	
		Setting range	On, Off	On, Off	On, Off	
		Default value	On	On	On	
	Target Select2	Parameter	CBGD			
		Setting range	On, Off			
		Default value	On			
	Register	Parameter	Page	No.	Rename (↓)	
		Setting range	1 to 10	1 to 10	Execute	
		Default value	1	1		
	Path	Parameter	Effect	Hue Path		
		Setting range	Cut, Dissolve	Short, Long, CW, CCW		
		Default value	Dissolve	Short		
Event Memory	Mark	Parameter	PAUSE	CLIP	GPI-Out	
		Setting range	On, Off	Off, Clip1, Clip2	Off, GPI-O1 to GPI-O19	
		Default value	Off	Off	Off	
	Event Duration	Parameter	(Time)	Set		
		Setting range	0 to 215999* (Frame)	Execute		
		Default value	1s00f			
	Total Duration	Parameter	(Time)	Set		
		Setting range	0 to 215999* (Frame)	Execute		
		Default value	1s00f			
	Timeline	Parameter	View			
		Setting range	Normal, Wide			
		Default value	Wide			
	Play	Parameter	Loop	Play Mode		
		Setting range	Once, Loop	Normal, Reverse		
		Default value	Once	Normal		
	Target Select1	Parameter	ME	DSK	AUX	
		Setting range	On, Off	On, Off	On, Off	
		Default value	On	On	On	
	Target Select2	Parameter	CBGD	CLIP		
		Setting range	On, Off	On, Off		
		Default value	On	On		
	Register	Parameter	Page	No.	Rename (↓)	
		Setting range	1 to 10	1 to 10	Execute	
		Default value	1	1		
Path	Parameter	Trans Path	Hue Path			
	Setting range	Linear, Spline, Step	Short, Long, CW, CCW, Step			
	Default value	Linear	CW			

*: Items with frame count indications will in fact be displayed with the time corresponding to the Format.

Setting menu table

Menu	Sub menu		Parameter 1	Parameter 2	Parameter 3	Parameter 4
	Use [F1] to select.		Use [F2] to select.	Use [F3] to select.	Use [F4] to select.	Use [F5] to select.
XPT	XPT Assign 1/6	Parameter	XPT1 Signal	XPT2 Signal	XPT3 Signal	XPT4 Signal
		Setting range	IN1, IN2, SDI IN3 to 8, IN-A1, IN-A2, IN-A3, IN-A4, IN-B1, IN-B2, IN-B3, IN-B4, Black, CBGD 1, CBGD 2, CBAR, Still 1V, Still 1K, Still 2V, Still 2K, Clip 1V, Clip 1K, Clip 2V, Clip 2K, CLN, ME PGM, Key Out, None			
		Default value	IN1	IN2	SDI IN3	SDI IN4
	XPT Assign 2/6	Parameter	XPT5 Signal	XPT6 Signal	XPT7 Signal	XPT8 Signal
		Setting range	The setting range is the same as for the XPT Assign 1/6 sub menu.			
		Default value	SDI IN5	SDI IN6	SDI IN7	SDI IN8
	XPT Assign 3/6	Parameter	XPT9 Signal	XPT10 Signal	XPT11 Signal	XPT12 Signal
		Setting range	The setting range is the same as for the XPT Assign 1/6 sub menu.			
		Default value	CBAR	CBGD 1	CBGD 2	None
	XPT Assign 4/6	Parameter	XPT13 Signal	XPT14 Signal	XPT15 Signal	XPT16 Signal
		Setting range	The setting range is the same as for the XPT Assign 1/6 sub menu.			
		Default value	None	None	None	None
	XPT Assign 5/6	Parameter	XPT17 Signal	XPT18 Signal	XPT19 Signal	XPT20 Signal
		Setting range	The setting range is the same as for the XPT Assign 1/6 sub menu.			
		Default value	None	None	None	None
	XPT Assign 6/6	Parameter	XPT21 Signal	XPT22 Signal	XPT23 Signal	XPT24 Signal
		Setting range	The setting range is the same as for the XPT Assign 1/6 sub menu.			
		Default value	None	None	None	None
	XPT Setting	Parameter	Shift	Shift-Lock		
		Setting range	Off, Right, Left	On, Off		
	Default value	Right	Off			
XPT Switch	Parameter	Timing				
	Setting range	Any, Field1, Field2				
	Default value	Any				
Multi View Display	MV	Parameter	Select			
		Setting range	MV1, MV2			
		Default value	MV1			

Setting menu table

Menu	Sub menu		Parameter 1	Parameter 2	Parameter 3	Parameter 4
	Use [F1] to select.		Use [F2] to select.	Use [F3] to select.	Use [F4] to select.	Use [F5] to select.
Multi View Display When MV1	MV Split	Parameter	Split			
		Setting range	4Split, 5-aSplit, 5-bSplit, 6-aSplit, 6-bSplit, 9Split, 10-aSplit, 10-bSplit, 12Split, 16Split			
		Default value	10-aSplit			
	MV Pattern 1/4	Parameter	Pos1 Signal	Pos2 Signal	Pos3 Signal	Pos4 Signal
		Setting range	IN1, IN2, SDI IN3, SDI IN4, SDI IN5, SDI IN6, SDI IN7, SDI IN8, IN-A1, IN-A2, IN-A3, IN-A4, IN-B1, IN-B2, IN-B3, IN-B4, Black, CBGD 1, CBGD 2, Still 1V, Still 1K, Still 2V, Still 2K, Clip 1V, Clip 1K, Clip 2V, Clip 2K, PGM, PVW, CLN, ME PGM, Key Out, MV1, MV2, AUX1, AUX2, AUX3, AUX4, Clock			
		Default value	PGM	PVW	IN1	IN2
	MV Pattern 2/4	Parameter	Pos5 Signal	Pos6 Signal	Pos7 Signal	Pos8 Signal
		Setting range	The setting range is the same as for the MV Pattern 1/4 sub menu.			
		Default value	SDI IN3	SDI IN4	SDI IN5	SDI IN6
	MV Pattern 3/4	Parameter	Pos9 Signal	Pos10 Signal	Pos11 Signal	Pos12 Signal
		Setting range	The setting range is the same as for the MV Pattern 1/4 sub menu.			
		Default value	SDI IN7	SDI IN8	Still 1V	Still 2V
	MV Pattern 4/4	Parameter	Pos13 Signal	Pos14 Signal	Pos15 Signal	Pos16 Signal
		Setting range	The setting range is the same as for the MV Pattern 1/4 sub menu.			
		Default value	Clip 1V	Clip 2V	AUX1	AUX2
	MV Frame	Parameter	Frame	Character	Label	
		Setting range	LUM0%, LUM25%, LUM50%, LUM75%, LUM100%, Off		On, Off	
		Default value	LUM75%		On	
	MV Tally Group1	Parameter	Box	Label Left	Label Right	
		Setting range	On, Off	On, Off	On, Off	
		Default value	Off	Off	Off	
	MV Tally Group2	Parameter	Box	Label Left	Label Right	
		Setting range	On, Off	On, Off	On, Off	
		Default value	Off	Off	Off	
	Display	Parameter	Level Meter	Input Status	Marker	Marker Size
		Setting range	OFF, IN ON, OUT ON, IN/OUT ON	On, Off	4:3, 16:9, Off	80 to 100%
	Default value	OFF	On	Off	95%	

Setting menu table

Menu	Sub menu	Parameter	Parameter 1	Parameter 2	Parameter 3	Parameter 4
	Use [F1] to select.		Use [F2] to select.	Use [F3] to select.	Use [F4] to select.	Use [F5] to select.
Multi View Display When MV2	MV Split	Parameter	Split			
		Setting range	4Split, 5-aSplit, 5-bSplit, 6-aSplit, 6-bSplit, 9Split, 10-aSplit, 10-bSplit, 12Split, 16Split			
		Default value	10-aSplit			
	MV Pattern 1/4	Parameter	Pos1 Signal	Pos2 Signal	Pos3 Signal	Pos4 Signal
		Setting range	IN1, IN2, SDI IN3, SDI IN4, SDI IN5, SDI IN6, SDI IN7, SDI IN8, IN-A1, IN-A2, IN-A3, IN-A4, IN-B1, IN-B2, IN-B3, IN-B4, Black, CBGD 1, CBGD 2, Still 1V, Still 1K, Still 2V, Still 2K, Clip 1V, Clip 1K, Clip 2V, Clip 2K, PGM, PVW, CLN, ME PGM, Key Out, MV1, MV2, AUX1, AUX2, AUX3, AUX4, Clock			
		Default value	IN1	IN2	CBGD 1	CBGD 2
	MV Pattern 2/4	Parameter	Pos5 Signal	Pos6 Signal	Pos7 Signal	Pos8 Signal
		Setting range	The setting range is the same as for the MV Pattern 1/4 sub menu.			
		Default value	CBAR	Black	Still 1K	Clip 1K
	MV Pattern 3/4	Parameter	Pos9 Signal	Pos10 Signal	Pos11 Signal	Pos12 Signal
		Setting range	The setting range is the same as for the MV Pattern 1/4 sub menu.			
		Default value	CLN	ME PGM	Key Out	AUX1
	MV Pattern 4/4	Parameter	Pos13 Signal	Pos14 Signal	Pos15 Signal	Pos16 Signal
		Setting range	The setting range is the same as for the MV Pattern 1/4 sub menu.			
		Default value	AUX2	AUX3	AUX4	Clock
	MV Frame	Parameter	Frame	Character	Label	
		Setting range	LUM0%, LUM25%, LUM50%, LUM75%, LUM100%, Off		On, Off	
		Default value	LUM75%		On	
	MV Tally Red	Parameter	Box	Label Left	Label Right	
		Setting range	On, Off	On, Off	On, Off	
		Default value	Off	Off	Off	
	MV Tally Green	Parameter	Box	Label Left	Label Right	
		Setting range	On, Off	On, Off	On, Off	
		Default value	Off	Off	Off	
Display	Parameter	Level Meter	Input Status	Marker	Marker Size	
	Setting range	OFF, IN ON, OUT ON, IN/OUT ON	On, Off	4:3, 16:9, Off	80 to 100%	
	Default value	OFF	On	Off	95%	
Input	Input	Parameter	Select		Color Space	SDI/HDMI
		Setting range	IN1, IN2, SDI IN3, SDI IN4, SDI IN5, SDI IN6, SDI IN7, SDI IN8, IN-A1, IN-A2, IN-A3, IN-A4, IN-B1, IN-B2, IN-B3, IN-B4		HDR BT.2020, HDR BT.709, SDR BT.709	SDI IN, HDMI IN
		Default value	IN1		SDR BT.709	SDI IN

Setting menu table

Menu	Sub menu	Parameter	Parameter 1	Parameter 2	Parameter 3	Parameter 4
	Use [F1] to select.		Use [F2] to select.	Use [F3] to select.	Use [F4] to select.	Use [F5] to select.
Input (SDI) / X(***) ● IN1, IN2, SDI IN3 to 8, IN-A1 to 4 or IN-B1 to 4 is displayed in the X part. ● The material name (up to 32 characters) is displayed in the *** part.	Status	Parameter	Format	Audio	Color Space	
		Setting range				
		Default value				
	FS	Parameter	Mode	Delay		
		Setting range	Off, Normal, Auto	0F to 8F		
		Default value	Auto	0F		
	Freeze	Parameter	Select	Freeze		
		Setting range	Frame, Field	On, Off		
		Default value	Frame	Off		
	Name	Parameter	Type	Name		
		Setting range	Default, User			
		Default value	Default			
	Up/Down Converter	Parameter	Move Detect	Sharp		
		Setting range	1 to 5	1 to 5		
		Default value	3	3		
	ROI	Parameter	Pos-X	Pos-Y	Size	Pos-Speed
		Setting range	- 45.00 to 45.00	- 45.00 to 45.00	10.00 to 100.00	1 to 100
		Default value	0.00	0.00	100.0	50
	ROI Preset	Parameter	TransTime			
		Setting range	00s00f to 16s39f			
		Default value	01s00f			
	C/C Operation	Parameter	C/C	Limit		
		Setting range	On, Off	Off, 108, 104, 100		
		Default value	Off	Off		
	C/C Process	Parameter	Y-Gain	Pedestal	C-Gain	Hue
		Setting range	0.0 to 200.0	- 20.0 to 200.0	0.0 to 200.0	0.0 to 359.9
		Default value	100.0	0.0	100.0	0.0
	C/C Tone1 Black	Parameter	Red	Green	Blue	RGB Link
		Setting range	- 10.0 to 108.0	- 10.0 to 108.0	- 10.0 to 108.0	On, Off
		Default value	0.0	0.0	0.0	Off
	C/C Tone2 Gray L	Parameter	Red	Green	Blue	
		Setting range	- 10.0 to 108.0	- 10.0 to 108.0	- 10.0 to 108.0	
		Default value	33.3	33.3	33.3	
C/C Tone3 Gray H	Parameter	Red	Green	Blue		
	Setting range	- 10.0 to 108.0	- 10.0 to 108.0	- 10.0 to 108.0		
	Default value	66.6	66.6	66.6		
C/C Tone4 White	Parameter	Red	Green	Blue		
	Setting range	- 10.0 to 108.0	- 10.0 to 108.0	- 10.0 to 108.0		
	Default value	100.0	100.0	100.0		

Setting menu table

Menu	Sub menu		Parameter 1	Parameter 2	Parameter 3	Parameter 4
	Use [F1] to select.		Use [F2] to select.	Use [F3] to select.	Use [F4] to select.	Use [F5] to select.
Input (SDI) / X(***) • IN1, IN2, SDI IN3 to 8, IN-A1 to 4 or IN-B1 to 4 is displayed in the X part. • The material name (up to 32 characters) is displayed in the *** part.	C/C Matrix R/G	Parameter	R-G	R-B	G-R	G-B
		Setting range	- 0.60 to 0.60	- 0.60 to 0.60	- 0.60 to 0.60	- 0.60 to 0.60
		Default value	0.00	0.00	0.00	0.00
	C/C Matrix B	Parameter	B-R	B-G		
		Setting range	- 0.60 to 0.60	- 0.60 to 0.60		
		Default value	0.00	0.00		
	C/C Setting	Parameter	Init Target	Initialize	Copy Target	Copy From
		Setting range	Process, Tone, RGB Matrix, All	Execute	SDI IN5, SDI IN6, SDI IN7, SDI IN8, IN-A1, IN-A2, IN-A3, IN-A4, IN-B1, IN-B2, IN-B3, IN-B4	Execute
		Default value	All	-	SDI IN5	-
	Input (HDMI) / X(***) • IN1, IN2, IN-A1 to 4 or IN-B1 to 4 is displayed in the X part. • The material name (up to 10 characters) is displayed in the *** part.	Freeze	Parameter	Select	Freeze	
		Setting range	Frame, Field	On, Off		
		Default value	Frame	Off		
Limited		Parameter	Limited			
		Setting range	On, Off			
		Default value	Off			
Name		Parameter	Type	Name		
		Setting range	Default, User			
		Default value	Default			
HDMI Input		Parameter	Scale			
		Setting range	Fit-V, Fit-H, Full			
		Default value	Full			
HDMI Status		Parameter	Size	Dot Clock	H-Frequency	V-Frequency
		Setting range	-			
		Default value	***x****	***. *MHz	**.*kHz	**.*Hz
ROI		Parameter	Pos-X	Pos-Y	Size	Pos-Speed
		Setting range	- 45.00 to 45.00	- 45.00 to 45.00	10.00 to 100.00	1 to 100
		Default value	0.00	0.00	100.0	50
ROI Preset		Parameter	TransTime			
		Setting range	00s00f to 16s39f			
		Default value	01s00f			
C/C Operation		Parameter	C/C	Limit		
		Setting range	On, Off	Off, 108, 104, 100		
		Default value	Off	Off		
C/C Process		Parameter	Y-Gain	Pedestal	C-Gain	Hue
		Setting range	0.0 to 200.0	- 20.0 to 200.0	0.0 to 200.0	0.0 to 359.9
		Default value	100.0	0.0	100.0	0.0
C/C Tone1 Black		Parameter	Red	Green	Blue	RGB Link
	Setting range	- 10.0 to 108.0	- 10.0 to 108.0	- 10.0 to 108.0	On, Off	
	Default value	0.0	0.0	0.0	Off	

Setting menu table

Menu	Sub menu		Parameter 1	Parameter 2	Parameter 3	Parameter 4
	Use [F1] to select.		Use [F2] to select.	Use [F3] to select.	Use [F4] to select.	Use [F5] to select.
Input (HDMI) / X(***) • IN1, IN2, IN-A1 to 4 or IN-B1 to 4 is displayed in the X part. • The material name (up to 10 characters) is displayed in the *** part.	C/C Tone2 Gray L	Parameter	Red	Green	Blue	
		Setting range	- 10.0 to 108.0	- 10.0 to 108.0	- 10.0 to 108.0	
		Default value	33.3	33.3	33.3	
	C/C Tone3 Gray H	Parameter	Red	Green	Blue	
		Setting range	- 10.0 to 108.0	- 10.0 to 108.0	- 10.0 to 108.0	
		Default value	66.6	66.6	66.6	
	C/C Tone4 White	Parameter	Red	Green	Blue	
		Setting range	- 10.0 to 108.0	- 10.0 to 108.0	- 10.0 to 108.0	
		Default value	100.0	100.0	100.0	
	C/C Matrix R/G	Parameter	R-G	R-B	G-R	G-B
		Setting range	- 0.60 to 0.60	- 0.60 to 0.60	- 0.60 to 0.60	- 0.60 to 0.60
		Default value	0.00	0.00	0.00	0.00
	C/C Matrix B	Parameter	B-R	B-G		
		Setting range	- 0.60 to 0.60	- 0.60 to 0.60		
	Default value	0.00	0.00			
C/C Setting	Parameter	Init Target	Initialize	Copy Target	Copy From	
	Setting range	Process, Tone, RGB Matrix, All	Execute	IN-A1, IN-A2, IN-A3, IN-B1, IN-B2, IN-B3	Execute	
	Default value	All	-	-	-	
Input	Camera Settings1	Parameter	IP Address	Port	Edit IP Address	Scan IP Address
		Setting range	Need Edit/Scan Now Scanning... Not Detected Select From List	1 to 65535	Execute	Execute
		Default value	Need Edit/Scan	80		-
	Camera Settings2	Parameter	Edit User Name	Edit Password	Name	Network Status
		Setting range	Execute	Execute	Name registered on the camera	No IP Address, Now Checking..., Connected, Unauthorized, Not Connected
		Default value			-	No IP Address
	Camera Settings3	Parameter	Pan Direction	Tilt Direction		Tally (Group1)
		Setting range	Normal, Reverse	Normal, Reverse		Disable, Enable
		Default value	Normal	Normal		Enable
	Camera Settings4	Parameter	Zoom Direction	Focus Direction	Iris Direction	
	Setting range	Normal, Reverse	Normal, Reverse	Normal, Reverse		
	Default value	Normal	Normal	Normal		

Setting menu table

Menu	Sub menu	Parameter	Parameter 1	Parameter 2	Parameter 3	Parameter 4	
	Use [F1] to select.		Use [F2] to select.	Use [F3] to select.	Use [F4] to select.	Use [F5] to select.	
Output	Output	Parameter	Select	Mode	Color Space		
		Setting range	SDI OUT1, SDI OUT2, SDI OUT3, SDI OUT4, SDI OUT5, HDMI OUT1, HDMI OUT2, OUT-A1, OUT-A2, OUT-A3, OUT-A4, OUT-B1, OUT-B2, OUT-B3, OUT-B4	Normal, 1080p, 1080i, 720p	HDR BT.2020, HDR BT.709, SDR BT.709		
		Default value	SDI OUT1	Normal	SDR BT.709		
Output (SDI) / Y <ul style="list-style-type: none"> SDI OUT1 to SDI OUT5, OUT A1, OUT A2, OUT A3, OUT A4, OUT B1, OUT B2, OUT B3 or OUT B4 is displayed in the Y part. (OUT A1, OUT A2, OUT A3, OUT A4, OUT B1, OUT B2, OUT B3 and OUT B4 take effect when the AV-UHS5M2 unit has been connected.)	Assign	Parameter	Source				
		Setting range	PGM, PVW, CLN, ME PGM, AUX1, AUX2, AUX3, AUX4, MV1, MV2, Key Out				
		Default value	PGM(OUT1), PVW(OUT2), AUX1(OUT3), AUX2(OUT4), AUX3(OUT5), AUX4(OUTA1), AUX1(OUTA2), AUX2(OUTA3), AUX3(OUTA4), AUX3(OUTB1), AUX4(OUTB2), AUX1(OUTB3), AUX3(OUTB4)	Normal			
		Down Converter	Parameter	Delay	Sharp		
			Setting range	Minimum, 1F Fix	1 to 5		
			Default value	Minimum	3		

Setting menu table

Menu	Sub menu	Parameter	Parameter 1	Parameter 2	Parameter 3	Parameter 4
	Use [F1] to select.		Use [F2] to select.	Use [F3] to select.	Use [F4] to select.	Use [F5] to select.
Output (HDMI) / Y • HDMI OUT1, HDMI OUT2, OUT A1, OUT A2, OUT A3, OUT A4, OUT B1, OUT B2, OUT B3 or OUT B4 is displayed in the Y part.	Assign	Parameter	Source			
		Setting range	PGM, PVW, CLN, ME PGM, AUX1, AUX2, AUX3, AUX4, MV1, MV2, Key Out			
		Default value	MV1(HDMI OUT1), MV2(HDMI OUT2), AUX4(OUTA1), AUX1(OUTA2), AUX2(OUTA3), AUX3(OUTB1), AUX4(OUTB2), AUX1(OUTB3)			
	HDMI Output	Parameter	Size	Color	Scale	Move Detect
		Setting range	Auto, XGA, WXGA, SXGA, WSXGA+, UXGA, WUXGA, WQHD, Native	Auto, RGB, YUV444, YUV422	Fit-V, Fit-H, Full, Full90%, Full80%	1 to 5
		Default value	Auto	Auto	Full	3

Setting menu table

Menu	Sub menu		Parameter 1	Parameter 2	Parameter 3	Parameter 4
	Use [F1] to select.		Use [F2] to select.	Use [F3] to select.	Use [F4] to select.	Use [F5] to select.
Config	Operate	Parameter	Bus Mode	Time Unit	Delegation	
		Setting range	A/B, PGM-A/ PST-B, PGM-B/ PST-A	Sec, Frame	On, Off	
		Default value	PGM-A/PST-B	Sec	On	
	Key/DSK Link	Parameter	Key1	Key2	Key3	
		Setting range	Off, Group1, Group2, Group3	Off, Group1, Group2, Group3	Off, Group1, Group2, Group3	
		Default value	Off	Off	Off	
	Key/DSK Link	Parameter	DSK1	DSK2		
		Setting range	Off, Group1, Group2, Group3	Off, Group1, Group2, Group3		
		Default value	Off	Off		
	Assign	Parameter	FTB Source	DSK1 on AUX1	DSK2 on AUX2	
		Setting range	Still1, Still2, Clip1, Clip2, CBGD1, CBGD2, White, Black	On, Off	On, Off	
		Default value	Black	Off	Off	
	ROI	Parameter	SDI IN	IN-A	IN-B	
		Setting range	On, Off	On, Off	On, Off	
		Default value	Off	Off	Off	
	Latency	Parameter	BKGD	Key		
		Setting range	1F Fix, Minimum	1F Fix, Minimum		
		Default value	Minimum	Minimum		
	LCD Backlight	Parameter	Light	Adjust		
		Setting range	On, Off, 60, 120, 180	80%, 90%, 100%, 110%, 120%, 130%, 140%, 150%		
		Default value	On	100%		
	Button Illumination	Parameter	Dimmer	Lighting	XPT Color	Transition Color
		Setting range	Off, 80%, 90%, 100%, 110%, 120%, 130%, 140%, 150%		Input, Color Group1, Color Group2, Color Group3, Color Group4, Color Group5, Color Group6, Color Group7, Color Group8	
		Default value	100%	150%	Input	Input
	Color Group SDI IN 1/2	Parameter	IN1	IN2	SDI IN3	SDI IN4
		Setting range	Color Group1, Color Group2, Color Group3, Color Group4, Color Group5, Color Group6, Color Group7, Color Group8			
		Default value	Color Group1	Color Group1	Color Group1	Color Group1
	Color Group SDI IN 2/2	Parameter	SDI IN5	SDI IN6	SDI IN7	SDI IN8
		Setting range	The setting range is the same as for the Color Group SDI IN 1/2 sub menu.			
		Default value	Color Group1	Color Group1	Color Group1	Color Group1
	Color Group Option	Parameter	IN-A1	IN-A2	IN-A3	IN-A4
		Setting range	The setting range is the same as for the Color Group SDI IN 1/2 sub menu.			
		Default value	Color Group1	Color Group1	Color Group1	Color Group1

Setting menu table

Menu	Sub menu		Parameter 1	Parameter 2	Parameter 3	Parameter 4
	Use [F1] to select.		Use [F2] to select.	Use [F3] to select.	Use [F4] to select.	Use [F5] to select.
Config	Color Group Option	Parameter	IN-B1	IN-B2	IN-B3	IN-B4
		Setting range Default value	The setting range is the same as for the Color Group SDI IN 1/2 sub menu.			
			Color Group1	Color Group1	Color Group1	Color Group1
	Color Group Internal	Parameter	Black	CBGD 1	CBGD 2	CBAR
		Setting range Default value	The setting range is the same as for the Color Group SDI IN 1/2 sub menu.			
			Color Group1	Color Group1	Color Group1	Color Group1
	Color Group Still	Parameter	Still 1V	Still 1K	Still 2V	Still 2K
		Setting range Default value	The setting range is the same as for the Color Group SDI IN 1/2 sub menu.			
			Color Group1	Color Group1	Color Group1	Color Group1
	Color Group Clip	Parameter	Clip 1V	Clip 1K	Clip 2V	Clip 2K
		Setting range Default value	The setting range is the same as for the Color Group SDI IN 1/2 sub menu.			
			Color Group1	Color Group1	Color Group1	Color Group1
	Color Group Other 1/2	Parameter	CLN	ME PGM	Key Out	Shift
		Setting range Default value	The setting range is the same as for the Color Group SDI IN 1/2 sub menu.			
			Color Group1	Color Group1	Color Group1	Color Group1
	Color Group Other 2/2	Parameter	Macro Attach			
		Setting range Default value	The setting range is the same as for the Color Group SDI IN 1/2 sub menu.			
			Color Group1			
	Color Group Transition	Parameter	AUTO	CUT	MIX	WIPE
		Setting range Default value	The setting range is the same as for the Color Group SDI IN 1/2 sub menu.			
			Color Group1	Color Group1	Color Group1	Color Group1
	Color Group Next Trans	Parameter	BKGD	KEY		
		Setting range	The setting range is the same as for the Color Group SDI IN 1/2 sub menu.			
		Default value	Color Group1	Color Group1		
	Color Group KEY ON	Parameter	KEY1 ON	KEY2 ON	KEY3 ON	
		Setting range	The setting range is the same as for the Color Group SDI IN 1/2 sub menu.			
		Default value	Color Group1	Color Group1	Color Group1	
	Color Group DSK/FTB ON	Parameter	DSK1 ON	DSK2 ON	FTB ON	
		Setting range	The setting range is the same as for the Color Group SDI IN 1/2 sub menu.			
		Default value	Color Group1	Color Group1	Color Group1	
Button Color Group1	Parameter	R	G	B		
	Setting range	0.0 to 1.5	0.0 to 1.5	0.0 to 1.5		
	Default value	0.1	0.1	0.1		

Setting menu table

Menu	Sub menu		Parameter 1	Parameter 2	Parameter 3	Parameter 4
	Use [F1] to select.		Use [F2] to select.	Use [F3] to select.	Use [F4] to select.	Use [F5] to select.
Config	Button Color Group2	Parameter	R	G	B	
		Setting range	0.0 to 1.5	0.0 to 1.5	0.0 to 1.5	
		Default value	0.1	0.1	0.0	
	Button Color Group3	Parameter	R	G	B	
		Setting range	0.0 to 1.5	0.0 to 1.5	0.0 to 1.5	
		Default value	0.0	0.1	0.1	
	Button Color Group4	Parameter	R	G	B	
		Setting range	0.0 to 1.5	0.0 to 1.5	0.0 to 1.5	
		Default value	0.0	0.1	0.1	
	Button Color Group5	Parameter	R	G	B	
		Setting range	0.0 to 1.5	0.0 to 1.5	0.0 to 1.5	
		Default value	0.1	0.0	0.1	
	Button Color Group6	Parameter	R	G	B	
		Setting range	0.0 to 1.5	0.0 to 1.5	0.0 to 1.5	
		Default value	0.1	0.0	0.0	
	Button Color Group7	Parameter	R	G	B	
		Setting range	0.0 to 1.5	0.0 to 1.5	0.0 to 1.5	
		Default value	0.0	0.0	0.1	
	Button Color Group8	Parameter	R	G	B	
		Setting range	0.0 to 1.5	0.0 to 1.5	0.0 to 1.5	
		Default value	0.0	0.0	0.0	
	WFM	Parameter	Style	Mode		
		Setting range	Parade, Overlay	YPbPr, RGB, Y		
		Default value	Parade	YPbPr		
	Vector	Parameter	Bar Target			
		Setting range	75%, 100%			
		Default value	100%			
	User Button1-4	Parameter	User1	User2	User3	User4
		Setting range	Key1 PVW, Key2 PVW, Key3 PVW, DSK1 PVW, DSK2 PVW, GPII-EN, GPIO-EN, SHIFT, AUX Trans, AUX1 Trans, AUX2 Trans, DSK1 on AUX1, DSK2 on AUX2, Effect Dissolve, Macro Attach, None			
		Default value	Key1 PVW	Key2 PVW	Key3 PVW	DSK1 PVW
	User Button5-8	Parameter	User5	User6	User7	User8
		Setting range	The setting range is the same as for the User Button1-4 sub menu.			
	Default value	DSK2 PVW	AUX Trans	Effect Dissolve	SHIFT	
GPI-In Setting	Parameter	GPI-In Enable	AUX Sel			
	Setting range	On, Off	AUX1, AUX2, AUX3, AUX4			
	Default value	On	AUX1			

Setting menu table

Menu	Sub menu		Parameter 1	Parameter 2	Parameter 3	Parameter 4
	Use [F1] to select.		Use [F2] to select.	Use [F3] to select.	Use [F4] to select.	Use [F5] to select.
Config	GPI-In Port1/2	Parameter	Port1 Assign	Port2 Assign	Port3 Assign	Port4 Assign
		Setting range	No Assign, AUTO, CUT, KEY1 ON, KEY2 ON, KEY3 ON, DSK1 ON, DSK2 ON, FTB ON, BKGD AUTO, BKGD CUT, KEY1 AUTO, KEY1 CUT, REC Still1, REC Still2, REC Clip1, PLAY Clip1, STOP Clip1, REC Clip2, PLAY Clip2, STOP Clip2, AUX XPT1 to 24, TlyG1 DSBL, TlyG2 DSBL, AUX Tly DSBL, MACRO001 to 100, MACRO Cancel			
		Default value	No Assign	No Assign	No Assign	No Assign
	GPI-In Port2/2	Parameter	Port5 Assign	Port6 Assign	Port7 Assign	Port8 Assign
		Setting range	The setting range is the same as for the GPI-In Port1/2 sub menu.			
		Default value	No Assign	No Assign	No Assign	No Assign
	GPI-Out Setting	Parameter	GPI-Out Enable	AUX Tly Sel		
		Setting range	On, Off	AUX1, AUX2, AUX3, AUX4		
		Default value	On	AUX1		
	GPI-Out Port1/5	Parameter	Port1 Assign	Port2 Assign	Port3 Assign	Port4 Assign
		Setting range	No Assign, AUTO, CUT, KEY1 ON, KEY2 ON, KEY3 ON, DSK1 ON, DSK2 ON, FTB ON, BKGD AUTO, BKGD CUT, KEY1 AUTO, KEY1 CUT, TlyG1 SDI IN1 to TlyG1 SDI IN8, TlyG1 HDMI IN1, TlyG1 HDMI IN2, TlyG1 IN-A1 to TlyG1 IN-A4, TlyG1 IN-B1 to TlyG1 IN-B4, TlyG2 SDI IN1 to TlyG2 SDI IN8, TlyG2 HDMI IN1, TlyG2 HDMI IN2, TlyG2 IN-A1 to TlyG2 IN-A4, TlyG2 IN-B1 to TlyG2 IN-B4, AuxTly SDI IN1 to AuxTly SDI IN8, AuxTly HDMI IN1, AuxTly HDMI IN2, AuxTly IN-A1 to AuxTly IN-A4, AuxTly IN-B1 to AuxTly IN-B4, Event MEM			
		Default value	No Assign	No Assign	No Assign	No Assign
	GPI-Out Port2/5	Parameter	Port5 Assign	Port6 Assign	Port7 Assign	Port8 Assign
		Setting range	The setting range is the same as for the GPI-Out Port1/5 sub menu.			
		Default value	No Assign	No Assign	No Assign	No Assign
	GPI-Out Port3/5	Parameter	Port9 Assign	Port10 Assign	Port11 Assign	Port12 Assign
		Setting range	The setting range is the same as for the GPI-Out Port1/5 sub menu.			
		Default value	No Assign	No Assign	No Assign	No Assign
	GPI-Out Port4/5	Parameter	Port13 Assign	Port14 Assign	Port15 Assign	Port16 Assign
		Setting range	The setting range is the same as for the GPI-Out Port1/5 sub menu.			
		Default value	No Assign	No Assign	No Assign	No Assign
	GPI-Out Port5/5	Parameter	Port17 Assign	Port18 Assign	Port19 Assign	
		Setting range	The setting range is the same as for the GPI-Out Port1/5 sub menu.			
		Default value	No Assign	No Assign	No Assign	
System Menu	Parameter	Lock				
	Setting range	On, Off				
	Default value	Off				

Setting menu table

Menu	Sub menu		Parameter 1	Parameter 2	Parameter 3	Parameter 4
	Use [F1] to select.		Use [F2] to select.	Use [F3] to select.	Use [F4] to select.	Use [F5] to select.
Config	Key Source Signal Coupling1	Parameter	Fill/Source			
		Setting range	Fill To Source, Source To Fill			
		Default value	Fill To Source			
	Key Source Signal Coupling2	Parameter	IN1	IN2	SDI IN3	SDI IN4
		Setting range	IN1, IN2, SDI IN3, SDI IN4, SDI IN5, SDI IN6, SDI IN7, SDI IN8, IN-A1, IN-A2, IN-A3, IN-A4, IN-B1, IN-B2, IN-B3, IN-B4, Black, CBGD 1, CBGD 2, CBAR, Still 1V, Still 1K, Still 2V, Still 2K, Clip 1V, Clip 1K, Clip 2V, Clip 2K			
		Default value	IN1	IN2	SDI IN3	SDI IN4
	Key Source Signal Coupling3	Parameter	SDI IN5	SDI IN6	SDI IN7	SDI IN8
		Setting range	The setting range is the same as for the Key Source Signal Coupling2 sub menu.			
		Default value	SDI IN5	SDI IN6	SDI IN7	SDI IN8
	Key Source Signal Coupling4	Parameter	IN-A1	IN-A2	IN-A3	IN-A4
		Setting range	The setting range is the same as for the Key Source Signal Coupling2 sub menu.			
		Default value	IN-A1	IN-A2	IN-A3	IN-A4
	Key Source Signal Coupling5	Parameter	IN-B1	IN-B2	IN-B3	IN-B4
		Setting range	The setting range is the same as for the Key Source Signal Coupling2 sub menu.			
		Default value	IN-B1	IN-B2	IN-B3	IN-B4
	Key Source Signal Coupling6	Parameter	Black	CBGD 1	CBGD 2	CBAR
		Setting range	The setting range is the same as for the Key Source Signal Coupling2 sub menu.			
		Default value	Black	CBGD 1	CBGD 2	CBAR
	Key Source Signal Coupling7	Parameter	Still 1V	Still 1K	Still 2V	Still 2K
		Setting range	The setting range is the same as for the Key Source Signal Coupling2 sub menu.			
		Default value	Still 1V	Still 1K	Still 2V	Still 2K
	Key Source Signal Coupling8	Parameter	Clip 1V	Clip 1K	Clip 2V	Clip 2K
		Setting range	The setting range is the same as for the Key Source Signal Coupling2 sub menu.			
		Default value	Clip 1V	Clip 1K	Clip 2V	Clip 2K
System/Locked (When locked)			(All menus grayed out)			

Setting menu table

Menu	Sub menu	Parameter	Parameter 1	Parameter 2	Parameter 3	Parameter 4
	Use [F1] to select.		Use [F2] to select.	Use [F3] to select.	Use [F4] to select.	Use [F5] to select.
System (When unlocked)	Format	Parameter	Format	Switcher Mode	Color Space	
		Setting range	2160/59.94P, 50P, 29.97P, 25P, 24P, 23.98P 1080/59.94P, 50P, 59.94i, 50i, 29.97p, 25p, 24p, 23.98p, 29.97Psf, 25Psf, 24Psf, 23.98Psf 720/59.94P, 50P	2K, 4K	HDR, BT.2020, HDR BT.709, SDR BT.709	
		Default value	1080/59.94i	2K	SDR BT.709	
	Output Phase	Parameter	System	H-Phase	V-Phase	
		Setting range	0H, 1H	- 0.50 to 0.49	- 100 to 100	
		Default value	0H	0	0	
	Reference	Parameter	Sync	BB Setup	Gen Lock	
		Setting range	BB, BB Advanced, Tri- level Sync, Internal	0IRE, 7.5IRE	Locked, Unlock	
		Default value	BB	7.5IRE	Unlock	
	Ancillary1	Parameter	AUX	PGM	PVW	CLN
		Setting range	On, Off	On, Off	On, Off	On, Off
		Default value	Off	Off	Off	Off
	Ancillary2	Parameter	MV			
		Setting range	PGM, PVW, Off			
		Default value	Off			
	Audio1	Parameter	AUX1	AUX2	AUX3	AUX4
		Setting range	IN1, IN2, SDI IN3 to 8, IN-A1 to 4, IN-B1 to 4, Follow Video, OFF			
		Default value	Follow Video			
	Audio2	Parameter	PGM	PVW	CLN	MV
		Setting range	IN1, IN2, SDI IN3 to 8, IN-A1 to 4, IN-B1 to 4, Follow Video, OFF			
		Default value	Follow Video			
	Test Tone	Parameter	Color Bar			
		Setting range	Normal, Low, Off			
	Default value	Normal				

Setting menu table

Menu	Sub menu		Parameter 1	Parameter 2	Parameter 3	Parameter 4
	Use [F1] to select.		Use [F2] to select.	Use [F3] to select.	Use [F4] to select.	Use [F5] to select.
System (When unlocked)	Alarm	Parameter	Power	Fan	Temperature	
		Setting range	Alarm, No Alarm	Alarm, No Alarm	Alarm, No Alarm	
		Default value				
	Initial	Parameter	Initial	Fader Initial		
		Setting range	Execute	Execute		
		Default value				
	Network1	Parameter	IP Address			
		Setting range	0 to 255			
		Default value	192.168.0.8			
	Network2	Parameter	Subnet Mask			
		Setting range	0 to 255			
		Default value	192.168.0.8			
	Network3	Parameter	Default Gateway			
		Setting range	0 to 255			
		Default value	192.168.0.8			
	Network4	Parameter	MAC Address			
		Setting range	Display only			
		Default value				
	ExtPanel Info	Parameter	Disable/Enable	PortNo		
		Setting range	Disable, Enable	62000 to 65535		
		Default value	Disable	62010		
	ExtPanelip SMEMRecall1	Parameter	ME	DSK	AUX	
		Setting range	On, Off	On, Off	On, Off	
		Default value	Off	Off	Off	
	ExtPanelip SMEMRecall2	Parameter	CBGD	XPT		
		Setting range	On, Off	On, Off		
		Default value	Off	Off		
	ExtControl Switcher	Parameter	Disable/Enable	PortNo	IntervalTime	Response
		Setting range	Disable, Enable	62000 to 65535	0ms, 16ms, 32ms, 48ms 64ms, 80ms	On, Off
		Default value	Disable	62000	16ms	Off
	ExtControl AUX Panel1	Parameter	IP Address1	IP Address2	IP Address3	IP Address4
		Setting range	0 to 255	0 to 255	0 to 255	0 to 255
		Default value	0.0.0.0	0.0.0.0	0.0.0.0	0.0.0.0
	ExtControl AUX Panel2	Parameter	IP Address5	IP Address6	IP Address7	IP Address8
		Setting range	0 to 255	0 to 255	0 to 255	0 to 255
		Default value	0.0.0.0	0.0.0.0	0.0.0.0	0.0.0.0
ExtControl AUX Panel3	Parameter	IP Address9	IP Address10	IP Address11	IP Address12	
	Setting range	0 to 255	0 to 255	0 to 255	0 to 255	
	Default value	0.0.0.0	0.0.0.0	0.0.0.0	0.0.0.0	

Setting menu table

Menu	Sub menu		Parameter 1	Parameter 2	Parameter 3	Parameter 4
	Use [F1] to select.		Use [F2] to select.	Use [F3] to select.	Use [F4] to select.	Use [F5] to select.
System (When unlocked)	ExtControl AUX Panel4	Parameter	IP Address13	IP Address14	IP Address15	IP Address16
		Setting range Default value	0 to 255 0.0.0.0	0 to 255 0.0.0.0	0 to 255 0.0.0.0	0 to 255 0.0.0.0
	ExtControl AUX Panel5	Parameter	IP Address17	IP Address18	IP Address19	IP Address20
		Setting range Default value	0 to 255 0.0.0.0	0 to 255 0.0.0.0	0 to 255 0.0.0.0	0 to 255 0.0.0.0
	ExtControl AUX Panel6	Parameter	PortNo			
		Setting range Default value	60000 to 65535 65000			
	Macro Trigger Control1	Parameter	Disable/Enable			
		Setting range Default value	Disable, Enable Disable			
	Macro Trigger Control2	Parameter	IP Address1	Macro1	IP Address2	Macro2
		Setting range Default value	0 to 255 0.0.0.0	No Assign, Macro001 to Macro100 No Assign	0 to 255 0.0.0.0	No Assign, Macro001 to Macro100 No Assign
	Macro Trigger Control3	Parameter	IP Address3	Macro3	IP Address4	Macro4
		Setting range Default value	0 to 255 0.0.0.0	No Assign, Macro001 to Macro100 No Assign	0 to 255 0.0.0.0	No Assign, Macro001 to Macro100 No Assign
	Macro Trigger Control4	Parameter	IP Address5	Macro5	IP Address6	Macro6
		Setting range Default value	0 to 255 0.0.0.0	No Assign, Macro001 to Macro100 No Assign	0 to 255 0.0.0.0	No Assign, Macro001 to Macro100 No Assign
	Macro Trigger Control5	Parameter	IP Address7	Macro7	IP Address8	Macro8
		Setting range Default value	0 to 255 0.0.0.0	No Assign, Macro001 to Macro100 No Assign	0 to 255 0.0.0.0	No Assign, Macro001 to Macro100 No Assign

Setting menu table

Menu	Sub menu		Parameter 1	Parameter 2	Parameter 3	Parameter 4
	Use [F1] to select.		Use [F2] to select.	Use [F3] to select.	Use [F4] to select.	Use [F5] to select.
System (When unlocked)	Macro Trigger Control6	Parameter	IP Address9	Macro9	IP Address10	Macro10
		Setting range	0 to 255	No Assign, Macro001 to Macro100	0 to 255	No Assign, Macro001 to Macro100
		Default value	0.0.0.0	No Assign	0.0.0.0	No Assign
	Macro Trigger Control7	Parameter	IP Address11	Macro11	IP Address12	Macro12
		Setting range	0 to 255	No Assign, Macro001 to Macro100	0 to 255	No Assign, Macro001 to Macro100
		Default value	0.0.0.0	No Assign	0.0.0.0	No Assign
	Macro Trigger Control8	Parameter	IP Address13	Macro13	IP Address14	Macro14
		Setting range	0 to 255	No Assign, Macro001 to Macro100	0 to 255	No Assign, Macro001 to Macro100
		Default value	0.0.0.0	No Assign	0.0.0.0	No Assign
	Macro Trigger Control9	Parameter	IP Address15	Macro15	IP Address16	Macro16
		Setting range	0 to 255	No Assign, Macro001 to Macro100	0 to 255	No Assign, Macro001 to Macro100
		Default value	0.0.0.0	No Assign	0.0.0.0	No Assign
	Macro Trigger Control10	Parameter	IP Address17	Macro17	IP Address18	Macro18
		Setting range	0 to 255	No Assign, Macro001 to Macro100	0 to 255	No Assign, Macro001 to Macro100
		Default value	0.0.0.0	No Assign	0.0.0.0	No Assign
	Macro Trigger Control11	Parameter	IP Address19	Macro19	IP Address20	Macro20
		Setting range	0 to 255	No Assign, Macro001 to Macro100	0 to 255	No Assign, Macro001 to Macro100
		Default value	0.0.0.0	No Assign	0.0.0.0	No Assign
	Tally Mode	Parameter	Tally Target			
		Setting range	On, Off			
	Default value	On				

Setting menu table

Menu	Sub menu		Parameter 1	Parameter 2	Parameter 3	Parameter 4
	Use [F1] to select.		Use [F2] to select.	Use [F3] to select.	Use [F4] to select.	Use [F5] to select.
System (When unlocked)	Tally MV Color	Parameter	Group1	Group2		
		Setting range	Red	Green		
		Default value	Red	Green		
	Tally Target	Parameter	Group1	Group2		
		Setting range	Off, PGM, CLN, ME PGM, Key Out, AUX1, AUX2, AUX3, AUX4			
		Default value	PGM	PVW		
	Now	Parameter	Get Date	Get Time		
		Setting range	Execute	Execute		
		Default value				
	Date	Parameter	Year	Month	Day	Set
		Setting range	2000 to 2037	1 to 12	1 to 31	Execute
		Default value	-	-	-	
	Time	Parameter	Hour	Minute	Second	Set
		Setting range	0 to 23	0 to 59	0 to 59	Execute
		Default value	-	-	-	
	System Version	Parameter	System Version		Set	Delete
		Setting range	Version number		Execute	Execute
		Default value				
	System Core Version	Parameter	System Core Version		Update	
		Setting range	Version number		Execute	
		Default value				
	Option	Parameter	Slot A	Slot B		
		Setting range	SDI-IN, HDMI-IN, SDI-OUT, HDMI-OUT, 4K-DVE, None			
	Default value					

Appendix (glossary)

Defined below are the terms used in this manual.

Word	Explanation
AB Bus system	A bus control mode. By executing a transition, the A bus and B bus signals are output to the program images alternately.
Ancillary Data	The auxiliary data other than the video signals which is transmitted inside the data stream of the video serial interface. The data superimposed on the vertical blanking period is referred to as the V ancillary data (VANC).
Aspect ratio	The ratio between the horizontal and vertical dimensions of an image or screen. It is 16:9 for the HD format and 4:3 for the SD format.
AUX [Auxiliary Bus]	A spare bus which can be switched by signals other than the main line output signals.
BB [Black burst]	The black burst signal. A full-screen black level composite signal which is used as the reference signal for gen-lock.
Border	The area or margin that is added to the edge of a wipe or key. Its width and color can be adjusted. The defocusing of the area around a border is referred to as the soft effect.
Chroma key	This refers to the function for creating the key signals based on the color information of the video signals and combining the keys.
Clip	The threshold level of the luminance when key signals are created from a key source.
Color Background	The signals which are output from the internal color generator and used as the background image.
Cut	This refers to the effect where the display is instantly switched to the next image.
Density	A parameter which is used to adjust the density of the key signals.
Down Converter	This is the function that converts material in the 4K format into the 2K/HD format.
DSK [Downstream Key]	This refers to the key combination process which is performed at the end of the mix effect. The key is always combined with the foremost image.
DVE [Digital Video Effect]	This refers to the transition patterns accompanying size reductions or slide effects.
Embedded Audio	This refers to the audio data packets which are transferred inside the data stream of the video serial interface.
Flip Flop system (PGM/PST system)	A bus control mode. The signals selected by the program bus are always output as the program images. By executing a transition, the program bus and preset bus signals are switched over.
Flying Key	This function uses DVE effects to move, expand or reduce key signals.
Frame Synchronizer	A function which matches the synchronization of non-synchronized video input signals.
Freeze	A function which continues the display of the same image, creating the impression that the image has been "frozen".
FTB [Fade to Black]	This is the effect where the background image is faded out to the black screen.
Genlock	A function for synchronizing the video signals using an external sync signal as the reference.
GPI [General Purpose Interface]	Interface signals which control auto transition from an external source.
Hue	The color tone of the video signals.
IRE	A unit used for video signal levels. The setup level (black level) of the signals is expressed as 0 IRE, 7.5 IRE, etc.
Key Edge	The border or shadow added to the edges of keys.

Appendix (glossary)

Word	Explanation
Key Fill	The signal that uses key combination processing to fill in the areas left blank by the key signals.
Key Gain	A parameter which is used to adjust the amplitude of the key signals.
Key Invert	A function which inverts the key signals.
Key Mask	This is the function that specifies the area for key combination using the box pattern, etc. When only part of the area of the key signals is used, key combination is executed with the unnecessary area masked.
Key Source	The video signals for creating the key signals.
Line Synchronizer	A function to automatically adjust the input image signal phase to the horizontal synchronization reference signal phase.
Linear Key	The function which combines keys using monochrome key signals with gradations in its outlines as a reference.
Lum [Luminance]	The brightness portion of the video signals.
Luminance Key	The function which creates key signals based on the luminance (brightness) information of the video signals to combine keys.
ME [Mix Effect]	A video effect device which combines a number of video signals to create mix, wipe, key and other video signals.
Mix	The picture-changing effect produced by overlapping one image with the next. It is also referred to as "dissolve".
Multi View Display	This function combines multiple materials and displays them on one screen. PGM, PVW and the input material can be previewed at the same time on a single screen.
PinP [Picture in Picture]	This function combines a sub screen image with the background image.
PVW [Preview]	The function for checking ahead of time the image which will be output after the next transition. The image is output from the PVW system.
PGM [Program Bus]	The bus which always carries the program output signals.
PST [Preset Bus]	The bus which carries the program output signals after the next background transition.
Sat [Saturation]	This refers to the intensity of the color chrominance level of video signals.
SDI [Serial Digital Interface]	The standard by which video signals in various SD and HD formats are transmitted along a single coaxial cable.
Self Key	A function that creates key signals from key fill signals for combining keys.
Setup Data	The memory in which the control panel statuses can be saved and recalled. The button selection statuses as well as the border, color and other setting information can be saved in this memory.
Tally	The signal which outputs the program output statuses of the input signals to an external device. The LED that indicates the program output status on the control panel is also referred to as tally.
Transition	A function that switches from one image to another. Wipe, mix and other effects are available for the images during switching.
Tri-level Sync	The sync signal used for HD formats.
Trimming	This is the function that eliminates the unnecessary parts at the top, bottom, left and/or right of the images which are combined using the PinP function.

Appendix (glossary)

Word	Explanation
Up Converter	This is the function that converts material in the 2K/HD format into the 4K format which yields a high resolution.
Video Memory	This is the memory in which the images (still images and moving images) with key signals can be stored.
Wipe	A video effect in which one image is gradually replaced by another as the boundary between the two is moved using a preselected pattern.

Index

A	
AUX bus crosspoint button	18
B	
Background	176
3D Modify	176
Border	176
Border Color	176
Clip Trans Sync	176
Modify	176
Position	176
Transition Margin	176
Transition Time	176
BKGD, KEY pattern selector button	19
C	
Camera	186
ABB	187
AWB	186
Camera Control	186
Camera Information	186
Control Speed	186
Gain1	187
Gain2	187
Lens Control	186
Lock	187
OSD Menu & Color Bars	186
Pedestal	187
Preset Settings	187
Chroma Key	182
Adjust	182
Adjusting Mode	182
Auto Compute	182
Chroma Key	182
Fine Tuning	182
Sampling	182
Sampling Area	182
Value	182
Color Background	177
CBGD1 Main	177
CBGD1 Move	177
CBGD1 Sub	177
CBGD1 Wash	177
CBGD1 Wave	177
CBGD2 Main	177
CBGD2 Move	177
CBGD2 Sub	177
CBGD2 Wash	177
CBGD2 Wave	177
Config	200
Assign	200
Button Color Group1	201
Button Color Group2	202
Button Color Group3	202
Button Color Group4	202
Button Color Group5	202
Button Color Group6	202
Button Color Group7	202
Button Color Group8	202
Button Illumination	200
Color Group Clip	201
Color Group DSK/FTB ON	201
Color Group Internal	201
Color Group KEY ON	201
Color Group Next Trans	201
Color Group Option	200
Color Group Other 1/2	201
Color Group Other 2/2	201
Color Group SDI IN 1/2	200
Color Group SDI IN 2/2	200
Color Group Still	201
Color Group Transition	201
GPI-In Port1/2	203
GPI-In Port2/2	203
GPI-In Setting	202
GPI-Out Port1/5	203
GPI-Out Port2/5	203
GPI-Out Port3/5	203
GPI-Out Port4/5	203
GPI-Out Port5/5	203
GPI-Out Setting	203
Key/DSK Link	200
Key Source Signal Coupling1	204
Key Source Signal Coupling2	204
Key Source Signal Coupling3	204
Key Source Signal Coupling4	204
Key Source Signal Coupling5	204
Key Source Signal Coupling6	204
Key Source Signal Coupling7	204
Key Source Signal Coupling8	204
Latency	200
LCD Backlight	200
Operate	200
ROI	200
System Menu	203
User Button1-4	202
User Button5-8	202
Vector	202
WFM	202
D	
DSK1	182
Adjust	182
DSK	182
DSK On	183
DSK Priority	183
DSK Signal Coupling	183
Fill Matte	182
Mask	183
Mask Adjust	183
PinP	183
PinP Border	183
PinP Position	183
PinP Sync	183

Index

PinP Trim	183
PinP Trim Adjust	183
DSK2	184
Adjust	184
DSK	184
DSK On	184
DSK Priority	184
DSK Signal Coupling	184
Fill Matte	184
Mask	184
Mask Adjust	184

E

Event Memory	191
Event Duration	191
Mark	191
Path	191
Play	191
Register	191
Target Select1	191
Target Select2	191
Timeline	191
Total Duration	191

F

Fader lever	21
--------------------------	-----------

I

Input	194, 197
Camera Settings1	197
Camera Settings2	197
Camera Settings3	197
Camera Settings4	197
Input	194
Input (HDMI)	196
C/C Matrix B	197
C/C Matrix R/G	197
C/C Operation	196
C/C Process	196
C/C Setting	197
C/C Tone1 Black	196
C/C Tone2 Gray L	197
C/C Tone3 Gray H	197
C/C Tone4 White	197
Freeze	196
HDMI Input	196
HDMI Status	196
Limited	196
Name	196
ROI	196
ROI Preset	196
Input (SDI)	195
C/C Matrix B	196
C/C Matrix R/G	196
C/C Operation	195

C/C Process	195
C/C Setting	196
C/C Tone1 Black	195
C/C Tone2 Gray L	195
C/C Tone3 Gray H	195
C/C Tone4 White	195
Freeze	195
FS	195
Name	195
ROI	195
ROI Preset	195
Status	195
Up/Down Converter	195

K

Key1	178
3D Modify	178
Adjust	178
Edge1	178
Edge2	178
Edge Color	178
Fill Matte	178
Flying Key Aspect	178
Flying Key Rotation	178
Flying Key Rotation/Size	178
Key	178
Key On	179
Key Priority	179
Key Signal Coupling	179
Mask	179
Mask Adjust	179
PinP	179
PinP Border	179
PinP Position	179
PinP Sync	179
PinP Trim	179
PinP Trim Adjust	179
Position	178
Transition	178
Key2	180
Adjust	180
Edge1	180
Edge2	180
Edge Color	180
Fill Matte	180
Key	180
Key On	181
Key Priority	181
Key Signal Coupling	181
Mask	180
Mask Adjust	180
PinP	180
PinP Border	180
PinP Position	180
PinP Sync	181
PinP Trim	181
PinP Trim Adjust	181

Index

Key3	181
Adjust	181
Fill Matte	181
Key	181
Key On	181
Key Priority	181
Key Signal Coupling	181
Mask	181
Mask Adjust	181

L

LAN cable	140
------------------------	------------

M

Macro	190
Attach	191
Insert Delay	190
Macro Assign 1/6	190
Macro Assign 2/6	190
Macro Assign 3/6	190
Macro Assign 4/6	190
Macro Assign 5/6	190
Macro Assign 6/6	190
Register	191
Store Select1	190
Store Select2	190

Memory operation button	19
--------------------------------------	-----------

Menu	28
-------------------	-----------

Menu selection buttons	23, 28
-------------------------------------	---------------

Multi View Display	192
---------------------------------	------------

Display	193, 194
MV	192
MV Frame	193, 194
MV Pattern 1/4	193, 194
MV Pattern 2/4	193, 194
MV Pattern 3/4	193, 194
MV Pattern 4/4	193, 194
MV Split	193, 194
MV Tally Green	194
MV Tally Group1	193
MV Tally Group2	193
MV Tally Red	194

O

Output	198
Output	198

Output (HDMI)	199
Assign	199
HDMI Output	199

Output (SDI)	198
Assign	198
Down Converter	198

P

PGM/A bus crosspoint button	18
------------------------------------------	-----------

Positioner	24
-------------------------	-----------

Project File	188
Last Load Date	188
Last Load File	188
Project File	188
Target Select1	188
Target Select2	188

PST/B bus crosspoint button	18
------------------------------------------	-----------

R

Rotary encoder	23, 24, 28
-----------------------------	-------------------

S

SD Card	188
Card Information	188
Card Management	188
Create Thumbnail	188
File	188
Mode	188
Target Select1	188
Target Select2	188

Shot Memory	191
Path	191
Register	191
Target Select1	191
Target Select2	191

System	205
Alarm	206
Ancillary1	205
Ancillary2	205
Audio1	205
Audio2	205
Date	209
ExtControl AUX Panel1	206
ExtControl AUX Panel2	206
ExtControl AUX Panel3	206
ExtControl AUX Panel4	207
ExtControl AUX Panel5	207
ExtControl AUX Panel6	207
ExtControl Switcher	206
ExtPanel Info	206
ExtPanelip SMEMRecall1	206
ExtPanelip SMEMRecall2	206
Format	205
Initial	206
Macro Trigger Control1	207
Macro Trigger Control2	207
Macro Trigger Control3	207
Macro Trigger Control4	207
Macro Trigger Control5	207
Macro Trigger Control6	208

Index

Macro Trigger Control7	208	XPT Assign 6/6	192
Macro Trigger Control8	208	XPT Setting	192
Macro Trigger Control9	208	XPT Switch	192
Macro Trigger Control10	208		
Macro Trigger Control11	208		
Network1	206		
Network2	206		
Network3	206		
Network4	206		
Now	209		
Option	209		
Output Phase	205		
Reference	205		
System Core Version	209		
System Version	209		
Tally Mode	208		
Tally MV Color	209		
Tally Target	209		
Test Tone	205		
Time	209		

T

Time	185
AUX1 BUS Trans	185
AUX2 BUS Trans	185
BKGD	185
DSK1	185
DSK2	185
Effect Dissolve	185
FTB	185
Key1	185
Key2	185
Key3	185

U

User button	20
--------------------------	-----------

V

Video Memory	189
Limit Time	189
Memory	189
Play Mode1	189
Play Mode2	189
Rec1	189
Rec2	189
Rec3	189
Video Memory1	189
Video Memory2	189
Video Memory3	189

X

XPT	192
XPT Assign 1/6	192
XPT Assign 2/6	192
XPT Assign 3/6	192
XPT Assign 4/6	192
XPT Assign 5/6	192

Panasonic Corporation

Web Site: <https://www.panasonic.com>

© Panasonic Corporation 2020