

# Panasonic®

## Operating Instructions Functional Manual LCD Projector

Model No. **PT-AR100EA**

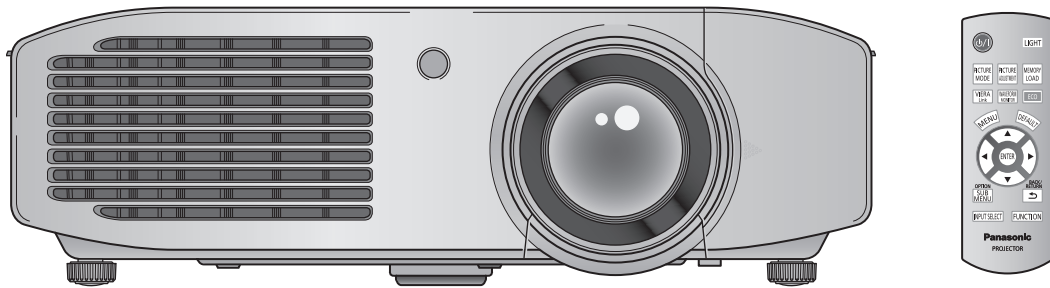

Thank you for purchasing this Panasonic product.

- Before operating this product, please read the instructions (Basic Guide / Functional Manual) carefully and save this manual for future use.
- Please ensure you read the “Read this first!” (➡ pages 6 to 12) carefully prior to use.

**HDMI™**  
HIGH-DEFINITION MULTIMEDIA INTERFACE

ENGLISH

TQBJ0406

**WARNING:**

This equipment has been tested and found to comply with the limits for a Class B digital device, pursuant to Part 15 of the FCC Rules. These limits are designed to provide reasonable protection against harmful interference in a residential installation.

This equipment generates, uses and can radiate radio frequency energy and, if not installed and used in accordance with the instructions, may cause harmful interference to radio communications.

However, there is no guarantee that interference will not occur in a particular installation. If this equipment does cause harmful interference to radio or television reception, which can be determined by turning the equipment off and on, the user is encouraged to try to correct the interference by one or more of the following measures:

- Reorient or relocate the receiving antenna.
- Increase the separation between the equipment and receiver.
- Connect the equipment into an outlet on a circuit different from that to which the receiver is connected.
- Consult the dealer or an experienced radio/TV technician for help.

**FCC CAUTION:** To assure continued compliance, use only shielded interface cables when connecting to computers or peripheral devices. Any unauthorized changes or modifications to this equipment will void the users authority to operate.

## Features of the Projector

### Harmonization with projection environment

- ▶ This projector is equipped with technology to automatically adjust the image according to the lighting of the projection environment (brightness, color).

### Improved brightness

- ▶ A newly developed high luminance lamp and an optical system have been introduced to facilitate the joy of viewing in a bright living room.

### Wide range of picture modes

- ▶ This projector is equipped with an exclusive mode for enjoying games and sports content at high image quality levels.

## Quick Steps

See the relevant page for details.

1. **Set up your projector**  
(➡ page 20)



2. **Connect the projector to other devices**  
(➡ page 25)



3. **Connect the power cord**  
(➡ page 27)



4. **Switch on the projector**  
(➡ page 28)



5. **Select the input signal**  
(➡ page 30)



6. **Adjust the image**  
(➡ page 30)

# Contents

Be sure to read "Read this first!". (→ pages 6 to 12)

## Important Information

<b>Read this first!</b> .....	<b>6</b>
<b>Precautions for use</b> .....	<b>13</b>
Cautions when transporting.....	13
Cautions when installing.....	13
Cautions on use .....	15
About disposal.....	15
Accessories .....	16
Optional accessories .....	16

## Introduction

<b>About your projector</b> .....	<b>17</b>
Remote control.....	17
Projector body .....	18

## Getting Started

<b>Setting up</b> .....	<b>20</b>
Projection method.....	20
Parts for ceiling mount (optional).....	20
Projection related .....	21
Front adjustable feet and throwing angle .....	22
Lens shift and positioning .....	23
<b>Connections</b> .....	<b>25</b>
Before connecting to the projector .....	25
Connecting example: COMPONENT IN/ S-VIDEO IN/VIDEO IN .....	25
Connecting example: HDMI IN/COMPUTER IN.....	26

## Basic Operation

<b>Switching the projector on/off</b> .....	<b>27</b>
Power cord .....	27
Power indicator .....	27
Switching on the projector .....	28
Switching off the power.....	29
<b>Projecting an image</b> .....	<b>30</b>
Selecting the input signal.....	30
Adjusting the image .....	30
<b>Remote control operation</b> .....	<b>31</b>

Illuminating button lights .....	31
Selecting the picture mode.....	31
Adjusting the picture .....	31
Loading a saved setting.....	32
Displaying the [VIERA LINK MENU] menu .....	32
Displaying the waveform monitor .....	32
Resetting to the default settings .....	32
Submenu.....	33
Switching the input signal .....	33
Using the <FUNCTION> button .....	33
Displaying the [ECO MANAGEMENT] menu.....	33

## Settings

<b>Menu navigation</b> .....	<b>34</b>
Navigating through the menu .....	34
Menu list .....	35
<b>[PICTURE] menu</b> .....	<b>37</b>
[PICTURE MODE].....	37
[CONTRAST] .....	37
[BRIGHTNESS] .....	37
[COLOUR].....	37
[TINT].....	37
[COLOUR TEMPERATURE] .....	38
[SHARPNESS].....	38
[DYNAMIC IRIS] .....	38
[LIGHT HARMONIZER] .....	38
[WAVEFORM MONITOR] .....	39
[SPLIT ADJUST] .....	41
[ADVANCED MENU] .....	42
[PICTURE MEMORY] .....	53
SIGNAL MODE.....	54
<b>[POSITION] menu</b> .....	<b>55</b>
[H-POSITION].....	55
[V-POSITION] .....	55
[DOT CLOCK].....	55
[CLOCK PHASE] .....	55
[ASPECT].....	56
[WSS] .....	58
[OVER SCAN].....	58
[KEystone] .....	58



[AUTO SETUP].....	58
[SCREEN AREA MEMORY].....	59
<b>[OPTION] menu .....</b>	<b>63</b>
[ON-SCREEN DISPLAY].....	63
[BACK COLOUR] .....	63
[STARTUP LOGO].....	64
[AUTO SEARCH].....	64
[HDMI SIGNAL LEVEL].....	64
[FRAME RESPONSE].....	64
[PROJECTION METHOD].....	64
[TRIGGER 1/2 SETTING] .....	65
[HIGH ALTITUDE MODE] .....	66
[LAMP POWER] .....	66
[ECO MANAGEMENT] .....	67
[FUNCTION BUTTON].....	68
[VIERA LINK SETTINGS].....	68
[OTHER FUNCTIONS].....	70
[TEST PATTERN] .....	70
[LAMP RUNTIME] .....	70

## Maintenance

<b>TEMP and LAMP Indicators.....</b>	<b>71</b>
Managing the indicated problems.....	71
<b>Care and replacement .....</b>	<b>73</b>
Before cleaning the projector / replacing components .....	73
Cleaning the projector.....	73
Component replacement.....	75
<b>Troubleshooting .....</b>	<b>80</b>
<b>Ceiling mount bracket safeguards .....</b>	<b>81</b>

## Appendix

<b>Using VIERA Link.....</b>	<b>82</b>
Summary of VIERA Link features .....	82
VIERA Link “HDAVI Control” .....	83
<b>Technical information.....</b>	<b>86</b>
List of compatible signals .....	86
Serial terminal .....	87
<b>Specifications .....</b>	<b>90</b>
Dimensions .....	92
<b>Index.....</b>	<b>93</b>

# Read this first!

**WARNING:** THIS APPARATUS MUST BE EARTHED.

**WARNING:** To prevent damage which may result in fire or shock hazard, do not expose this appliance to rain or moisture.

Machine Noise Information Ordinance 3. GSGV, January 18, 1991: The sound pressure level at the operator position is equal or less than 70 dB (A) according to ISO 7779.

**WARNING:**

1. Remove the plug from the mains socket when this unit is not in use for a prolonged period of time.
2. To prevent electric shock, do not remove cover. No user serviceable parts inside. Refer servicing to qualified service personnel.
3. Do not remove the earthing pin on the mains plug. This apparatus is equipped with a three prong earthingtype mains plug. This plug will only fit an earthing-type mains socket. This is a safety feature. If you are unable to insert the plug into the mains socket, contact an electrician. Do not defeat the purpose of the earthing plug.

**CAUTION:** To assure continued compliance, follow the attached installation instructions, which includes using the provided power cord and shielded interface cables when connecting to computer or peripheral device. If you use serial port to connect PC for external control of projector, you must use optional RS-232C serial interface cable with ferrite core. Any unauthorized changes or modifications to this equipment will void the user's authority to operate.

**IMPORTANT: THE MOULDED PLUG****FOR YOUR SAFETY, PLEASE READ THE FOLLOWING TEXT CAREFULLY.**

This appliance is supplied with a moulded three pin mains plug for your safety and convenience. A 13 amp fuse is fitted in this plug. Should the fuse need to be replaced, please ensure that the replacement fuse has a rating of 13 amps and that it is approved by ASTA or BSI to BS1362.

Check for the ASTA mark  or the BSI mark  on the body of the fuse.

If the plug contains a removable fuse cover, you must ensure that it is refitted when the fuse is replaced. If you lose the fuse cover, the plug must not be used until a replacement cover is obtained. A replacement fuse cover can be purchased from an Authorised Service Center.

**If the fitted moulded plug is unsuitable for the mains socket in your home, then the fuse should be removed and the plug cut off and disposed of safely. There is a danger of severe electrical shock if the cut off plug is inserted into any 13 amp socket.**

If a new plug is to be fitted, please observe the wiring code as shown below.

If in any doubt, please consult a qualified electrician.

**WARNING:** THIS APPLIANCE MUST BE EARTHED.

**IMPORTANT:** The wires in this mains lead are coloured in accordance with the following code:

Green - and - Yellow:	Earth
Blue:	Neutral
Brown:	Live

As the colours of the wire in the mains lead of this appliance may not correspond with the coloured markings identifying the terminals in your plug, proceed as follows.

The wire which is coloured GREEN - AND - YELLOW must be connected to the terminal in the plug which is marked with the letter E or by the Earth symbol or coloured GREEN or GREEN - AND - YELLOW.

The wire which is coloured BLUE must be connected to the terminal in the plug which is marked with the letter N or coloured BLACK.

The wire which is coloured BROWN must be connected to the terminal in the plug which is marked with the letter L or coloured RED.

**How to replace the fuse:** Open the fuse compartment with a screwdriver and replace the fuse.

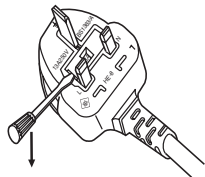

## Read this first!

### WARNING:

#### ■ POWER

**The wall outlet or the circuit breaker shall be installed near the equipment and shall be easily accessible when problems occur. If the following problems occur, cut off the power supply immediately.**

Continued use of the projector in these conditions will result in fire or electric shock.

- If foreign objects or water get inside the projector, cut off the power supply.
- If the projector is dropped or the cabinet is broken, cut off the power supply.
- If you notice smoke, strange smells or noise coming from the projector, cut off the power supply.

Please contact an Authorized Service Center for repairs, and do not attempt to repair the projector yourself.

**During a thunderstorm, do not touch the projector or the cable.**

Electric shocks can result.

**Do not do anything that might damage the power cord or the power plug.**

If the power cord is used while damaged, electric shocks, short-circuits or fire will result.

- Do not damage the power cord, make any modifications to it, place it near any hot objects, bend it excessively, twist it, pull it, place heavy objects on top of it or wrap it into a bundle.

Ask an Authorized Service Center to carry out any repairs to the power cord that might be necessary.

**Completely insert the power plug into the wall outlet and the power connector into the projector terminal.**

If the plug is not inserted correctly, electric shocks or overheating may occur and fire will result.

- Do not use plugs which are damaged or wall outlets which are coming loose from the wall.

**Do not use anything other than the provided power cord.**

Failure to observe this will result in electric shocks or fire.

**Clean the power plug regularly to prevent it from becoming covered in dust.**

Failure to observe this will cause a fire.

- If dust builds up on the power plug, the resulting humidity can damage the insulation.
  - If not using the projector for an extended period of time, pull the power plug out from the wall outlet.
- Pull the power plug out from the wall outlet and wipe it with a dry cloth regularly.

**Do not handle the power plug and power connector with wet hands.**

Failure to observe this will result in electric shocks.

**Do not overload the wall outlet.**

If the power supply is overloaded (ex., by using too many adapters), overheating may occur and fire will result.

**WARNING:****■ ON USE/INSTALLATION**

**Do not place the projector on soft materials such as carpets or sponge mats.**

Doing so will cause the projector to overheat, which can cause burns, fire or damage to the projector.

**Do not set up the projector in humid or dusty places or in places where the projector may come into contact with oily smoke or steam, ex. a bathroom.**

Using the projector under such conditions will result in fire, electric shocks or deterioration of components. Deterioration of components (such as ceiling mount brackets) may cause the projector which is mounted on the ceiling to fall down.

**Do not install this projector in a place which is not strong enough to take the full weight of the projector or on top of a surface which is sloped or unstable.**

Failure to observe this will cause projector to fall down or tip over the projector, and severe injury or damage could result.

**Do not cover the air inlet port or the air outlet port.**

Doing so will cause the projector to overheat, which can cause fire or damage to the projector.

- Do not place the projector in narrow, badly ventilated places such as closets or bookshelves.
- Do not place the projector on cloth or papers, as these materials could be drawn into the air inlet port.

**Do not place your hands or other objects close to the air outlet port.**

Doing so will cause burns or damage your hands or other objects.

- Heated air comes out of the air outlet port. Do not place your hands or face, or objects which cannot withstand heat close to this port.

**Do not cover the air intake/exhaust ports or place anything within 100 mm (4") of them.**

Doing so will cause the projector to overheat, which can cause fire or damage to the projector.

**Do not look and place your skin into the lights emitted from the lens while the projector is being used.**

Doing so can cause burns or loss of sight.

- Strong light is emitted from the projector's lens. Do not look or place your hands directly into this light.
- Be especially careful not to let young children look into the lens. In addition, turn off the main power when you are away from the projector.

**Never attempt to remodel or disassemble the projector.**

High voltages can cause fire or electric shocks.

- For any inspection, adjustment and repair work, please contact an Authorized Service Center.

**Do not project an image with the lens cover attached.**

Doing so can cause fire.

**Do not allow metal objects, flammable objects, or liquids to enter inside of the projector. Do not allow the projector to get wet.**

Doing so may cause short circuits or overheating, and result in fire, electric shock, or malfunction of the projector.

- Do not place containers of liquid or metal objects near the projector.
- If liquid enters inside of the projector, consult your dealer.
- Particular attention must be paid to children.

**Use the ceiling mount bracket specified by Panasonic.**

Defects in the ceiling mount bracket will result in falling accidents.

- Attach the supplied safety cable to the ceiling mount bracket to prevent the projector from falling down.

**Installation work (such as ceiling mount bracket) should only be carried out by a qualified technician.**

If installation is not carried out and secured correctly it can cause injury or accidents, such as electric shocks.

- Do not use anything other than an authorized ceiling mount bracket.
- Be sure to use the provided accessory wire with an eye bolt as an extra safety measure to prevent the projector from falling down. (Install in a different location to the ceiling mount bracket)

## Read this first!

### WARNING:

#### ■ ACCESSORIES

**Do not use or handle the batteries improperly, and refer to the following.**

Failure to observe this will cause burns, batteries to leak, overheat, explode or catch fire.

- Do not use unspecified batteries.
- Do not disassemble dry cell batteries.
- Do not heat the batteries or place them into water or fire.
- Do not allow the + and - terminals of the batteries to come into contact with metallic objects such as necklaces or hairpins.
- Do not store batteries together with metallic objects.
- Store the batteries in a plastic bag and keep them away from metallic objects.
- Make sure the polarities (+ and -) are correct when inserting the batteries.
- Do not use a new battery together with an old battery or mix different types of batteries.
- Do not use batteries with the outer cover peeling away or removed.

**If the battery fluid leaks, do not touch it with bare hands, and take the following measures if necessary.**

- Battery fluid on your skin or clothing could result in skin inflammation or injury.  
Rinse with clean water and seek medical advice immediately.
- Battery fluid coming in contact with your eyes could result in loss of sight.  
In this case, do not rub your eyes. Rinse with clean water and seek medical advice immediately.

**Do not disassemble the lamp unit.**

If the lamp breaks, it could cause injury.

#### Lamp replacement

The lamp has high internal pressure. If improperly handled, an explosion and severe injury or accidents will result.

- The lamp can easily explode if struck against hard objects or dropped.
- Before replacing the lamp, be sure to disconnect the power plug from the wall outlet.  
Electric shocks or explosions can result if this is not done.
- When replacing the lamp, turn the power off and allow the lamp to cool for at least one hour before handling it otherwise it can cause burns.

**Do not allow infants or pets to touch the remote control.**

- Keep the remote control out of the reach of infants and pets after using it.

**Do not use the supplied power cord with devices other than this projector.**

- Using the supplied power cord with devices other than this projector may cause short circuits or overheating, and result in electric shock or fire.

**Remove the depleted batteries from the remote control promptly.**

- Leaving them in the unit may result in fluid leakage, overheating, or explosion of the batteries.

**CAUTION:****■ POWER**

**When disconnecting the power cord, be sure to hold the power plug and power connector.**

If the power cord itself is pulled, the lead will become damaged, and fire, short-circuits or serious electric shocks will result.

**When not using the projector for an extended period of time, disconnect the power plug from the wall outlet and remove the batteries from the remote control.**

Failure to do so may result in fire or electric shock.

**Disconnect the power plug from the wall outlet before carrying out any cleaning and replacing the unit.**

Failure to do so may result in electric shock.

**■ ON USE/INSTALLATION**

**Do not place heavy objects on top of the projector.**

Failure to observe this will cause the projector to become unbalanced and fall, which could result in damage or injury. The projector will be damaged or deformed.

**Do not put your weight on this projector.**

You could fall or the projector could break, and injury will result.

- Be especially careful not to let young children stand or sit on the projector.

**Do not place the projector in extremely hot locations.**

Doing so will cause the outer casing or internal components to deteriorate, or result in fire.

- Take particular care in locations exposed to direct sunlight or near stoves.

**Always disconnect all cables before moving the projector.**

Moving the projector with cables still attached can damage the cables, which will cause fire or electric shocks to occur.

**■ ACCESSORIES**

**Do not use the old lamp unit.**

If used it could cause lamp explosion.

**If the lamp has broken, ventilate the room immediately. Do not touch or bring your face close to the broken pieces.**

Failure to observe this will cause the user to absorb the gas which was released when the lamp broke and which contains nearly the same amount of mercury as fluorescent lamps, and the broken pieces will cause injury.

- If you believe that you have absorbed the gas or that the gas has got into your eyes or mouth, seek medical advice immediately.
- Ask your dealer about replacing the lamp unit and check the inside of the projector.

## Read this first!

### To remove the battery Remote Control Battery

1. Press the guide and lift the cover.

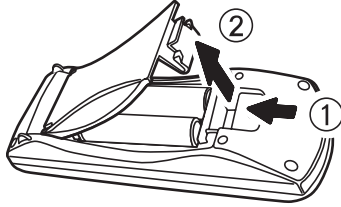

2. Remove the batteries.

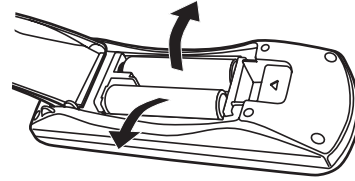

#### Trademarks

- VGA and XGA are trademarks of International Business Machines Corporation.
- SVGA is a registered trademark of the Video Electronics Standards Association.
- HDMI, the HDMI logo and High-Definition Multimedia Interface is a trademark or registered trademark of HDMI Licensing LLC.
- The font used in the on-screen displays is a Ricoh bitmap font, which is manufactured and sold by Ricoh Company, Ltd.
- Other names, company names or product names used in these operating instructions are the trademarks or registered trademarks of their respective holders.

Please note that the operating instructions do not include the ® and TM symbols.

#### Illustrations in these operating instructions

- Note that illustrations of the projector may differ from the ones you actually see.

#### Page references

- In these instructions, references to pages are indicated as: (➡ page 00).

#### Term

- In these instructions, the “Wireless remote control unit” accessory is referred to as the “Remote control”.



# Precautions for use

## ■ Be sure to use the projector after removing the packaging material, such as the fastening tapes and protective sheet.

Take proper care when disposing of the removed packaging material.

## Cautions when transporting

- Ensure that the supplied lens cover is attached when transporting.
- Hold the bottom of the projector when transporting.
- Do not transport with the front adjustable feet extended. Doing so may result in damage to the front adjustable feet.

## Cautions when installing

### ■ Do not set up the projector outdoors.

The projector is designed for indoor use only.

### ■ Do not use under the following conditions.

- Places where vibration and impacts occur such as in a car or vehicle: Doing so may damage the internal parts and result in malfunctions.
- Near the exhaust of an air conditioner: Depending on the conditions of use, the screen may fluctuate due to the hot air from the air exhaust port or the heated or cooled air from the air conditioner. Take care so that the exhaust from the projector or other equipment, or the air from the air conditioner does not blow toward the front of the projector.
- Near lights (studio lamps, etc.) where temperature changes greatly (See "Operating environment" ► page 90): Doing so may shorten the life of the lamp or result in deformation of the outer case and malfunctions.
- Near high-voltage power lines or near motors: Doing so may interfere with the operation of the projector.

### ■ About lens focus

The focus of high brightness projection lenses may not be stable immediately after turning power on due to the effects of heat from light coming from light sources. Adjust lens focus 30 minutes after starting to project a video.

### ■ Make sure to set [HIGH ALTITUDE MODE] to [ON] when using the projector at elevations of 1 400 m (4 593 ft) or higher and lower than 2 700 m (8 858 ft) above sea level.

Failure to do so may shorten the life of the internal parts and result in malfunctions.

### ■ Make sure to set [HIGH ALTITUDE MODE] to [OFF] when using the projector at elevations lower than 1 400 m (4 593 ft) above sea level.

Failure to do so may shorten the life of the internal parts and result in malfunctions.

### ■ Do not install the projector at elevations of 2 700 m (8 858 ft) or higher above sea level.

Failure to do so may shorten the life of the internal parts and result in malfunctions.

### ■ Do not tilt the projector or place it on its side.

Do not tilt the projector body more than approximately  $\pm 30^\circ$  vertically or  $\pm 10^\circ$  horizontally. Overtilting may result in shortening the component's lifespan.

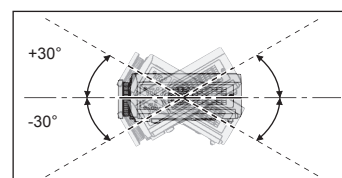

### ■ Do not cover the air intake/exhaust ports or place anything within 100 mm (4") of them.

### ■ Be sure to consult a specialized technician or your dealer when installing the product on a ceiling.

An optional ceiling mount bracket is required.

Model No.: ET-PKA110H (for high ceilings), ET-PKA110S (for low ceilings)

# Precautions for use

## Installation precautions

- Do not stack projectors.
- Do not cover the projector's air intake port or air exhaust port.
- Install the projector so that cold air or hot air from air conditioners does not come in to direct contact with the air intake port or air exhaust port.

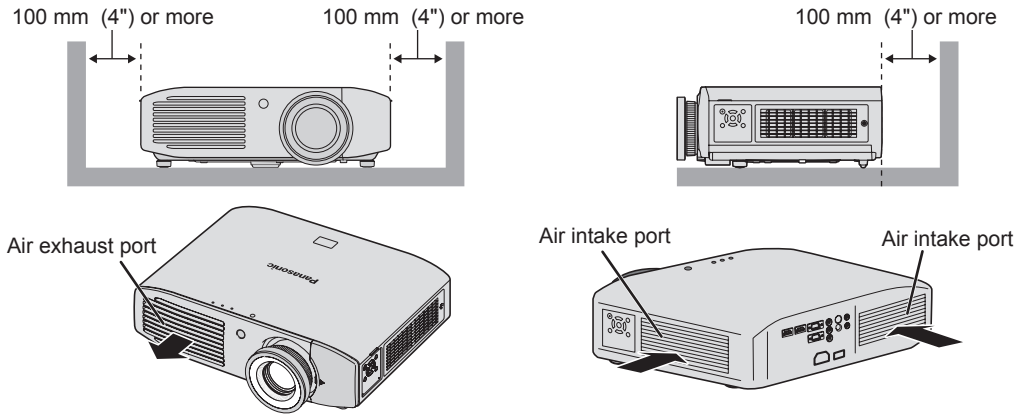

- Do not install the projector in an enclosed space.  
If the projector needs to be installed in an enclosure, provide a separate air conditioning unit or ventilating equipment. Emitted heat accumulates if ventilation is insufficient. This may cause the protection circuit of the projector to operate.
- Use the front adjustable feet for floor installation only and for angle adjustment in such cases.  
If you use the adjustable feet for any other purpose, the set may be damaged.

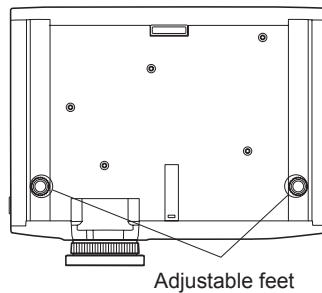

### Cautions on use

#### ■ In order to view clear video images

- Clear, high contrast video can be viewed when curtains are closed and lights near the screen are extinguished in order to stop light from reaching the screen.
- In some rare cases, depending on the usage environment a “flickering” may appear on the screen due to the effects of air from the exhaust port or hot/cold air from air conditioners. Do not set up this projector in a situation where air from the exhaust of this device or other devices, or air from air conditioners is circulated to the front of this device.
- The focus of high brightness projection lenses may not be stable immediately after turning power on due to the effects of heat from light coming from light sources. Focus stabilizes 30 minutes after video projection starts.

#### ■ Do not touch the surface of the projection lens with bare hands.

If fingerprints or dirt are left on the projection lens, they will be enlarged and projected and will prevent the viewing of clear video images. Also, always replace the lens cover when not using the projector.

#### ■ About LCD panels

LCD panels are manufactured using high precision technologies, but in some cases they may have dead pixels, or permanently lit pixels. Please understand that this is not a fault. Also, projecting a still image for extended periods of time may lead to afterimages on LCD panels. Please be aware that in some cases these afterimages may not disappear completely.

#### ■ About optical components

If using in an environment with a high temperature, or where dust or tobacco smoke is present, the replacement cycle of optical components such as LCD panels and polarizing plates may shorten even after less than one year of use. For more details, please contact your dealer.

#### ■ About the lamp

This product uses an internal high pressure mercury lamp for the light source. High pressure mercury lamps have the following characteristics.

- Brightness decreases with usage time.
- In some cases, the lamp may make a large sound, crack, and reach the end of its lifespan as a result of shocks, damage, and deterioration related to usage period.
- Large disparities occur in lifespan due to individual properties and usage conditions. Lifespan is especially affected if you use the lamp continuously for more than 6 hours or switch it ON/OFF rapidly.
- Very occasionally the lamp may crack after starting projection.
- The possibility of cracking increases as the lamp nears the end of its lifespan.
- If the lamp cracks, gas may be leaked from inside and smoke may be seen.
- Please prepare a spare lamp in advance.





### About disposal

To dispose of the product, inquire your local authorities or dealer for correct methods of disposal. The lamp contains mercury. When disposing of used lamp units, contact your local authorities or dealer for correct methods of disposal.

# Precautions for use

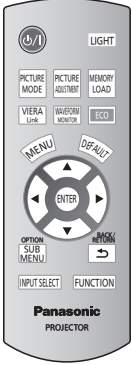
## Accessories

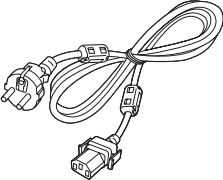
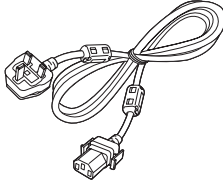
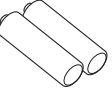
Please confirm that the items displayed below are included.

<p>Wireless remote control unit: 1 (N2QAYB000681)</p> 	<p>Lens cover: 1 (TEEC5524)</p>  <p>(Attached to the projector by default.)</p>	<p>Power cord: 1 (TXFSX01RXQZ)</p> 	<p>Power cord: 1 (TXFSX01RZRZ)</p> 
	<p>AA/R6 battery: 2</p>  <p>(For remote control unit)</p>	<p>CD-ROM: 1 (TXFQB02RWEZ)</p> 	

### Attention

- Dispose of the packaging appropriately after removing from the product.
- Contact an Authorized Service Center if you lose any of the included items.
- The model number of accessories and optional accessories may be changed without prior notification.
- Store small parts out of reach of infants.
- Store the lens cover properly.  
The lens cover protects the projection lens from dust and dirt.  
Attach the lens cover when not using the device.

## Optional accessories

Optional accessories (product names)	Model No.
Ceiling mount bracket	ET-PKA110H (for high ceilings), ET-PKA110S (for low ceilings)
Replacement lamp unit	ET-LAA110

# About your projector

## Remote control

### Top

#### Remote control signal transmitter

Send remote control signal.

Point at the remote control receiver part on the projector when using.

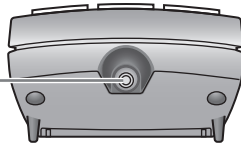

### Front

With the <MAIN POWER> switch of the projector turned <ON>, switch between the standby mode and projection mode.

Cycle through the [PICTURE MODE].

Display the [VIERA LINK MENU] menu.

Display the menu screen.

Display menus of external devices when using VIERA Link.  
Alter the points during a gamma adjustment.

Switch the input signals.

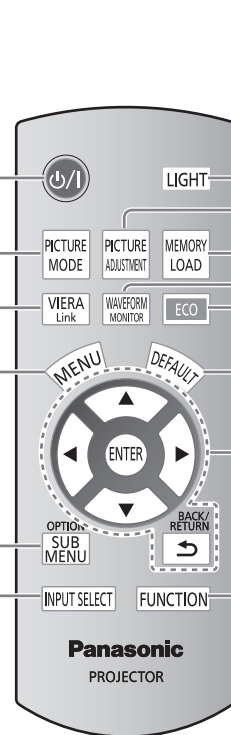

Switch the remote control button lights off or on.

Display the [PICTURE] menu or [ADVANCED MENU] menu.

Display the [MEMORY LOAD] menu.

Display the input waveform.

Display the [ECO MANAGEMENT] menu.

Reset adjusted menu values to the default settings.

Use for menu screen operation.

Allocate frequently used operations and use as a shortcut button.

### Inserting and removing the remote control batteries

Open the cover.

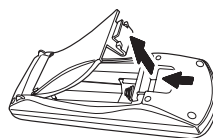

Insert the batteries and replace the cover (insert from - side).

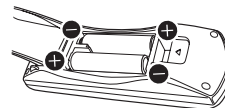

• Follow the reverse procedure to remove the batteries.

### Attention

- Do not drop the remote control.
- Avoid contact with liquids or moisture.
- Do not attempt to disassemble or modify the remote control.

### Note

- Pressing buttons on the remote control when button lights is set to on illuminates the button lights. Button lights dim if no actions are carried out after approximately 5 seconds, and then extinguish if no actions are carried out after a further 5 seconds.
- When pointed directly at the receiver on the front of the projector, the remote control can be used up to a distance of approximately 7 meters. It may also be used at a vertical/horizontal angle of up to  $\pm 30$  degrees.
- The remote control may not operate correctly if there is an obstacle between it and the receiver on the projector. Signals from the remote control can be reflected off a screen when using the projector, but limitations to the range of operability may occur due to reflected light loss resulting from the properties of the screen.
- The remote control may not be usable if the receiver is exposed to fluorescent or other strong lights. As far as is possible, keep the remote control away from light sources.

# About your projector

## Projector body

### Top and front view

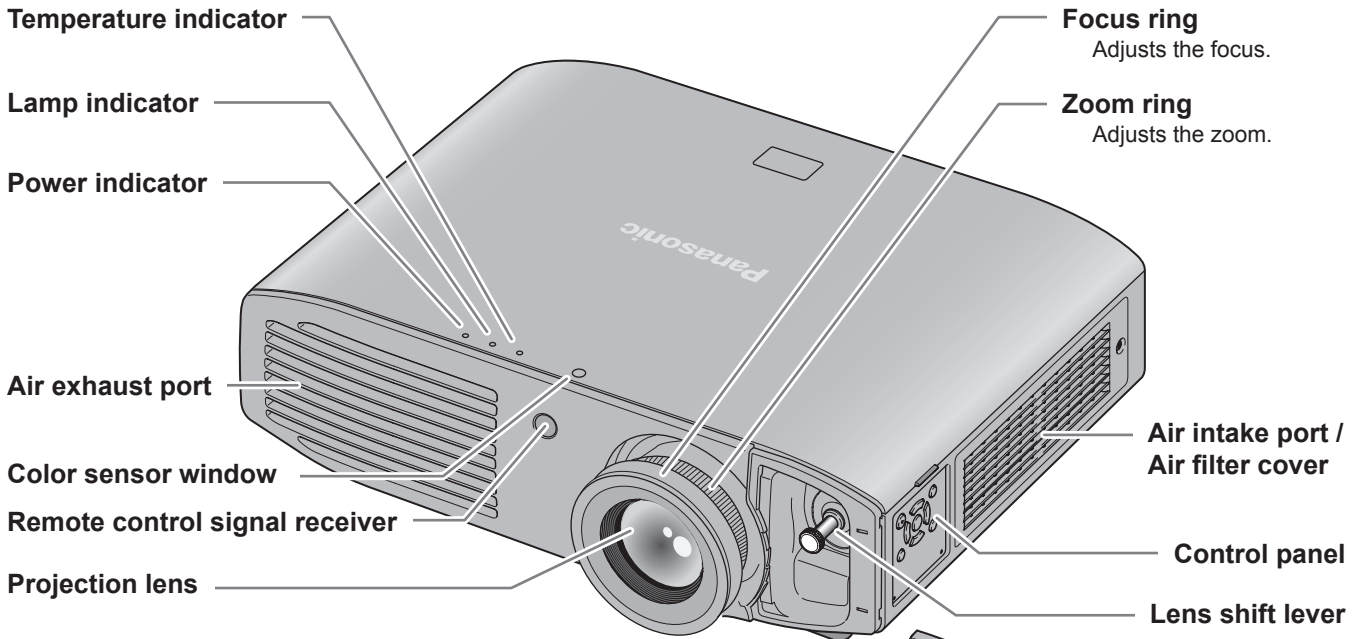

### Attention

- Do not place your hands or objects close to the exhaust port.
  - Do not place hands or face near.
  - Do not place near objects that are intolerant to heat.
  - Inserting fingers may result in injury.

Hot air is expelled from the exhaust port and can cause burns, injuries, and deformation.

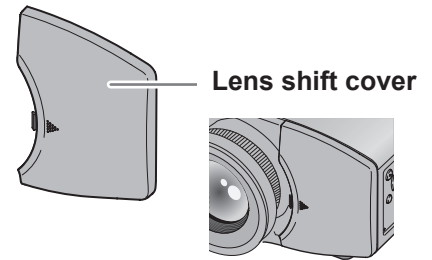

When the lens shift cover is closed

### Attention

- Ensure that there are no build ups of dirt on the air intake and exhaust ports.

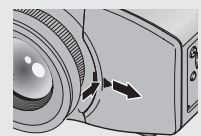

Press the cover and slide.

### Control panel

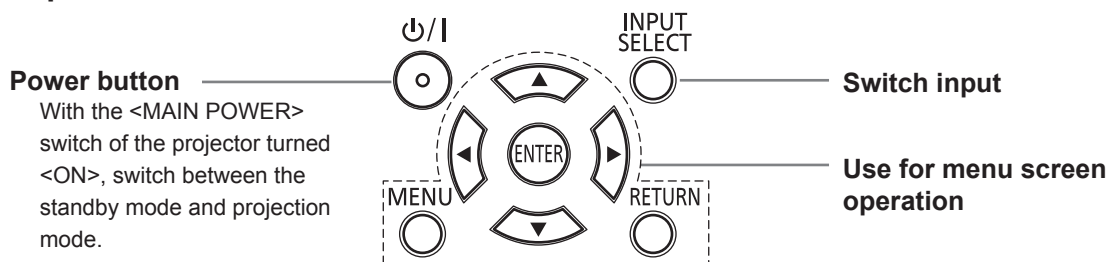

## ■ Back and bottom view

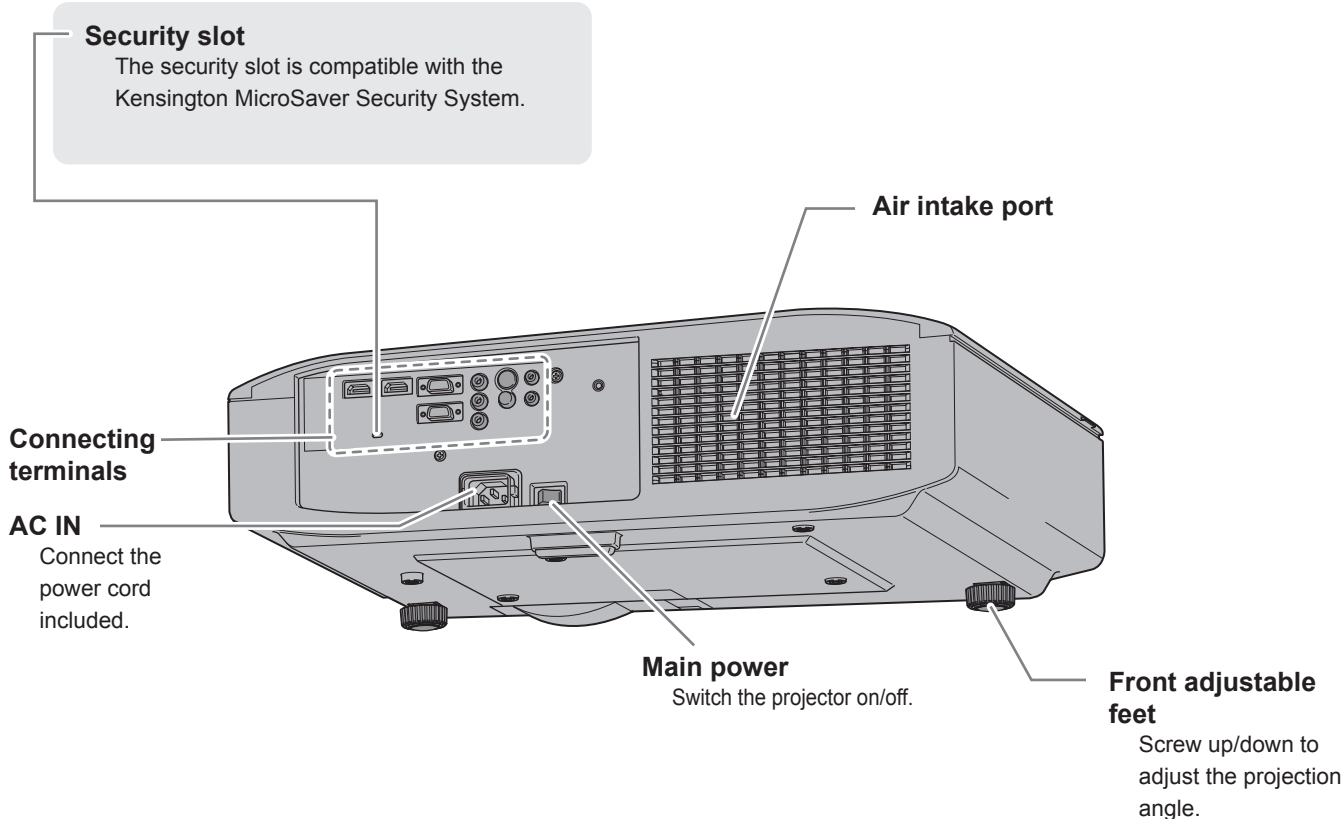

## ■ Connecting terminals

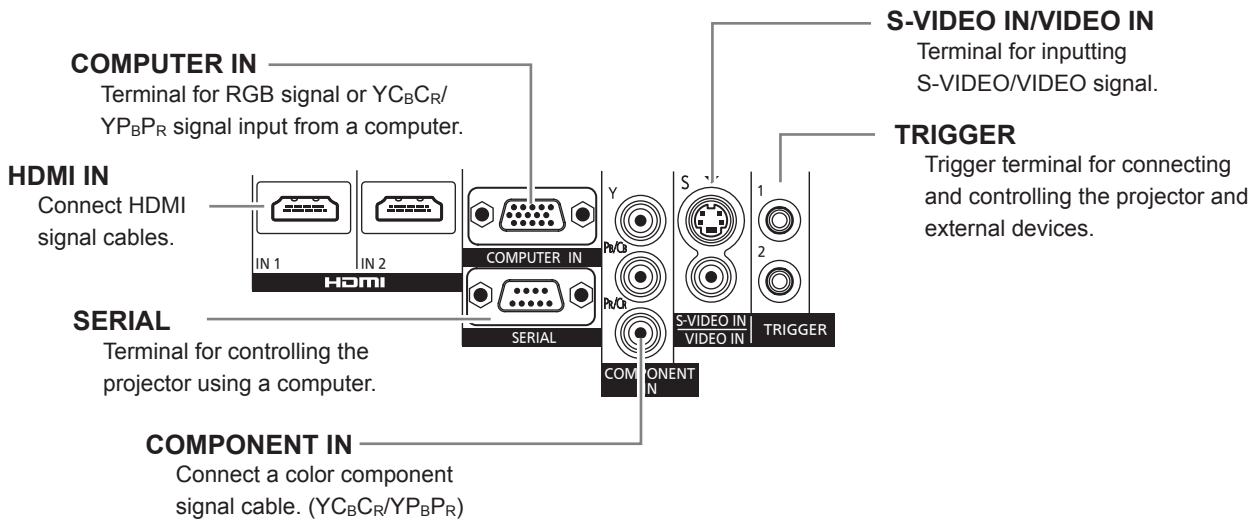

# Setting up

## Projection method

You can use any of the following 4 projection methods. Select a projection method suitable for the position of the projector.

For projection method settings, see [PROJECTION METHOD] in the [OPTION] menu. (▶ page 64)

### ■ Setting on a desk/floor and projecting from front

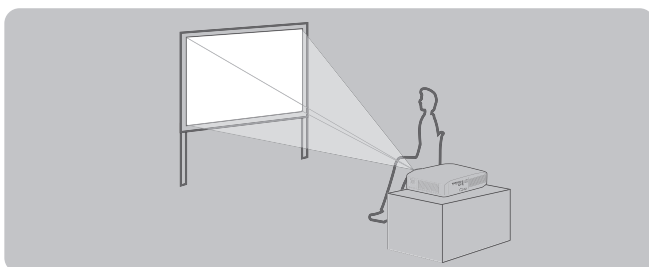

Menu	Method
[PROJECTION METHOD]	[FRONT/DESK]

### ■ Setting on a desk/floor and projecting from rear (using a translucent screen)

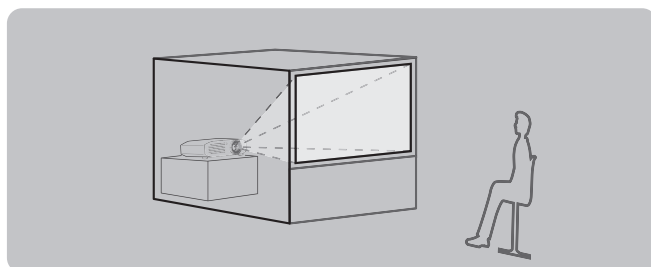

Menu	Method
[PROJECTION METHOD]	[REAR/DESK]

### ■ Mounting on the ceiling and projecting from front

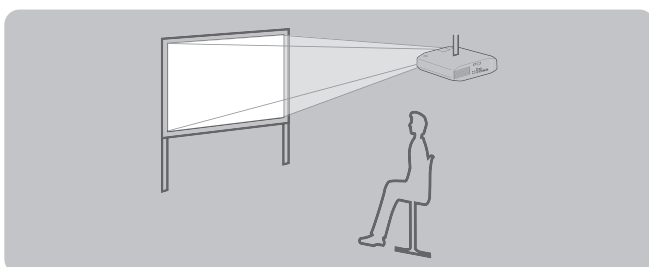

Menu	Method
[PROJECTION METHOD]	[FRONT/CEILING]

### ■ Mounting on the ceiling and projecting from rear (with a translucent screen)

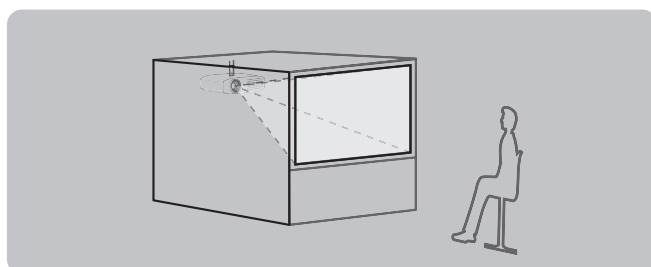

Menu	Method
[PROJECTION METHOD]	[REAR/CEILING]

## Parts for ceiling mount (optional)

You can install the projector on the ceiling using the optional ceiling mount bracket (model no.: ET-PKA110H (for high ceilings) and ET-PKA110S (for low ceilings)).

- Use only the ceiling mount brackets specified for this projector.
- Refer to the installation manual for the ceiling mount bracket when you install the bracket and the projector.

### Attention

To ensure projector performance and security, installation of the ceiling mount bracket must be carried by your dealer or a qualified technician.



## Projection related

Install the projector with reference to the figure below and the projection distance. You can adjust the display size and display position according to the screen size and screen position.

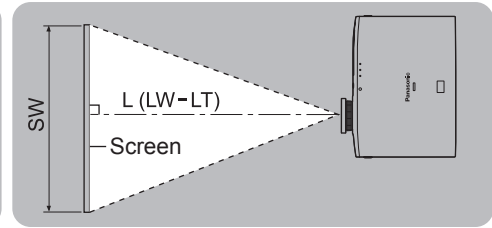
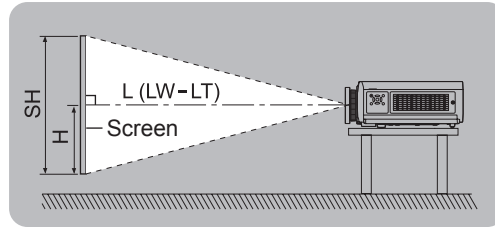
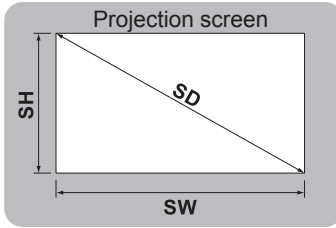

L (LW - LT) *1	Projection distance (m)
SH	Screen height (m)
SW	Screen width (m)
H	Distance from the center of the lens to the image lower end (m)
SD	Screen diagonal size (m)

\*1 LW: Minimum projection distance  
 LT: Maximum projection distance

(All measurements below are approximate and may differ slightly from the actual measurements.)

Projection screen size	16:9 size		
Screen Diagonal (SD)	Minimum distance (LW)	Maximum distance (LT)	Height position (H)
1.02 m (40")	1.11 m (3' 8")	2.29 m (7' 6")	-0.08 to 0.58 m
1.27 m (50")	1.41 m (4' 8")	2.87 m (9' 5")	-0.09 to 0.71 m
1.52 m (60")	1.70 m (5' 7")	3.46 m (11' 4")	-0.11 to 0.86 m
1.78 m (70")	1.99 m (6' 6")	4.04 m (13' 3")	-0.13 to 1.00 m
2.03 m (80")	2.28 m (7' 6")	4.62 m (15' 2")	-0.15 to 1.15 m
2.29 m (90")	2.57 m (8' 5")	5.21 m (17' 1")	-0.17 to 1.29 m
2.54 m (100")	2.87 m (9' 5")	5.79 m (19' 0")	-0.19 to 1.44 m
3.05 m (120")	3.45 m (11' 4")	6.96 m (22' 10")	-0.22 to 1.71 m
3.81 m (150")	4.33 m (14' 2")	8.70 m (28' 7")	-0.28 to 2.15 m
5.08 m (200")	5.79 m (19' 0")	11.62 m (38' 1")	-0.37 to 2.86 m
6.35 m (250")	7.25 m (23' 9")	14.53 m (47' 8")	-0.47 to 3.58 m
7.62 m (300")	8.71 m (28' 7")	17.45 m (57' 3")	-0.56 to 4.30 m

Projection screen size	2.35:1 size		
Screen Diagonal (SD)	Minimum distance (LW)	Maximum distance (LT)	Height position (H)
1.02 m (40")	1.18 m (3' 10")	2.43 m (8' 0")	-0.13 to 0.53 m
1.27 m (50")	1.49 m (4' 11")	3.04 m (10' 0")	-0.15 to 0.65 m
1.52 m (60")	1.80 m (5' 11")	3.66 m (12' 0")	-0.19 to 0.79 m
1.78 m (70")	2.11 m (6' 11")	4.27 m (14' 0")	-0.22 to 0.92 m
2.03 m (80")	2.42 m (7' 11")	4.89 m (16' 1")	-0.25 to 1.05 m
2.29 m (90")	2.73 m (8' 11")	5.51 m (18' 1")	-0.28 to 1.18 m
2.54 m (100")	3.04 m (10' 0")	6.12 m (20' 1")	-0.32 to 1.31 m
3.05 m (120")	3.66 m (12' 0")	7.35 m (24' 1")	-0.37 to 1.56 m
3.81 m (150")	4.58 m (15' 0")	9.20 m (30' 2")	-0.47 to 1.96 m
5.08 m (200")	6.13 m (20' 1")	12.28 m (40' 3")	-0.62 to 2.61 m
6.35 m (250")	7.67 m (25' 2")	15.36 m (50' 5")	-0.78 to 3.27 m
7.62 m (300")	9.22 m (30' 3")	18.44 m (60' 6")	-0.94 to 3.92 m

## Setting up

You can calculate projection dimensions other than those in the above table from the projection screen size SD (m) using the formula below.

All units are meters. (Values obtained using the formula below contain a slight error.)

If the projection screen size is assumed to be SD,

	16:9 size	2.35:1 size
Projection screen height (SH)	= SD (m) × 0.490	= SD (m) × 0.392
Projection screen width (SW)	= SD (m) × 0.872	= SD (m) × 0.920
Minimum distance (LW)	= SD (m) × 1.1503 – 0.056	= SD (m) × 1.2169 – 0.054
Maximum distance (LT)	= SD (m) × 2.2951 – 0.041	= SD (m) × 2.4248 – 0.037

## Front adjustable feet and throwing angle

Install the projector on a flat surface with its front side become parallel to the screen surface so that the screen becomes rectangle.

If the screen is tilted towards the bottom, extend the adjustable feet to make a rectangle screen. If the projector is tilted horizontally, use the adjustable feet to level the projector.

As shown in the diagram, the feet can be extended by turning the front adjustable feet, and can be retracted by turning in the opposite direction.

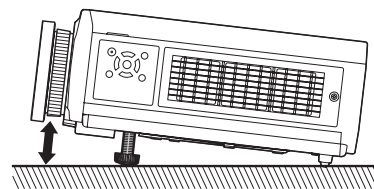
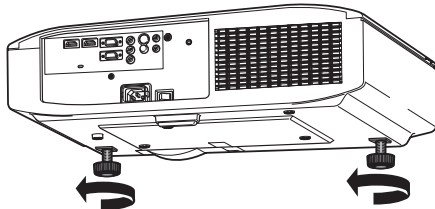

### Attention

- Hot air is expelled from the air exhaust port. Do not touch the air exhaust port (➔ page 18) directly when you adjust the front leg adjustable feet.

### Note

- Tighten the front adjustable feet until you hear them click into place.

## Lens shift and positioning

If the projector is not positioned right in front of the center of the screen, you can adjust the projected image position by moving the lens shift dials within the shift range of the lens.

### ■ Adjusting the lens shift

#### 1) Remove the lens shift cover.

- See “About your projector” (▶ page 18) regarding how to open the lens shift cover.

#### 2) Rotate the lens shift lever in the direction shown in the figure (counterclockwise) to release the lock.

#### 3) Adjust projection using the lens shift lever.

##### ● Horizontal shift

Adjust the projection by moving the lens shift lever horizontally according to the installation position of the screen and projector.

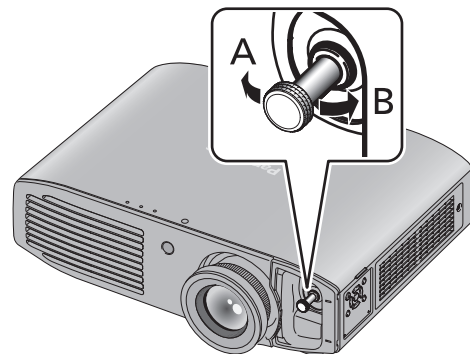
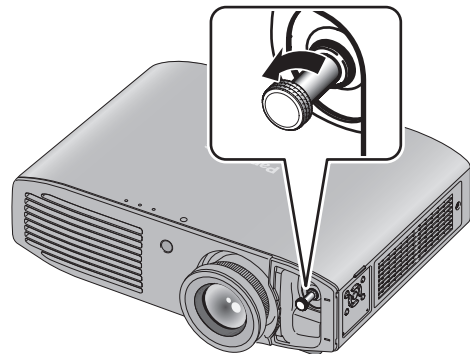
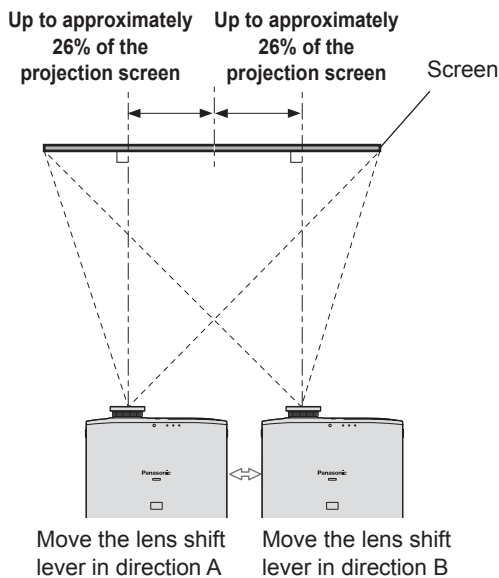

##### ● Vertical shift

Adjust by moving the lens shift lever vertically according to the installation position of the screen and projector.

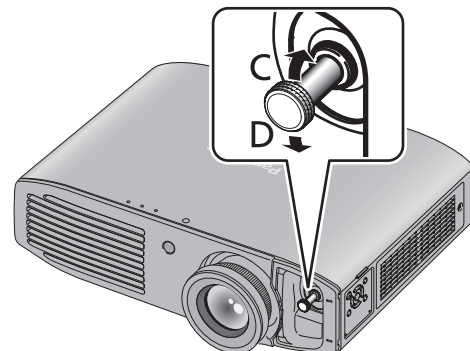
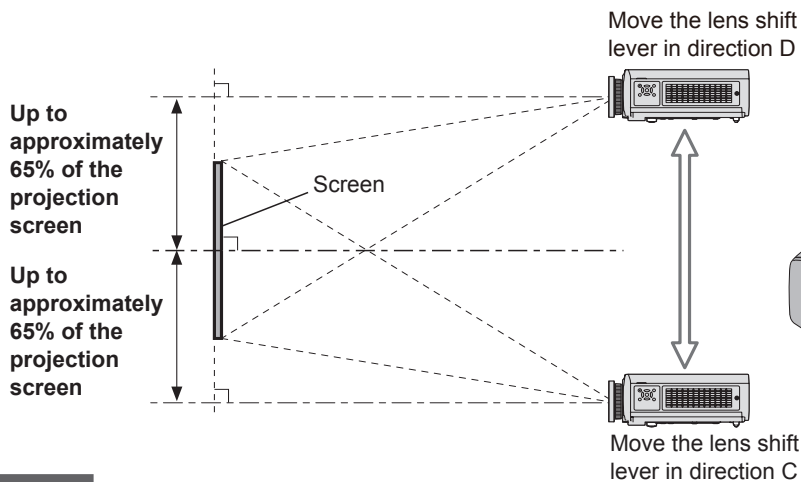

### Attention

- Do not force the lens shift lever. If excessive force is placed on the lever, it may break.

#### 4) Rotate the lens shift lever clockwise to fix.

#### 5) Attach the lens shift cover.

# Setting up

## Projector location range

The setting position can be adjusted within the following range.

See "Projection related" regarding adjustment of the projection screen height (SH) and width (SW). (➡ page 21)

### ● Projector setting range when the screen position is fixed

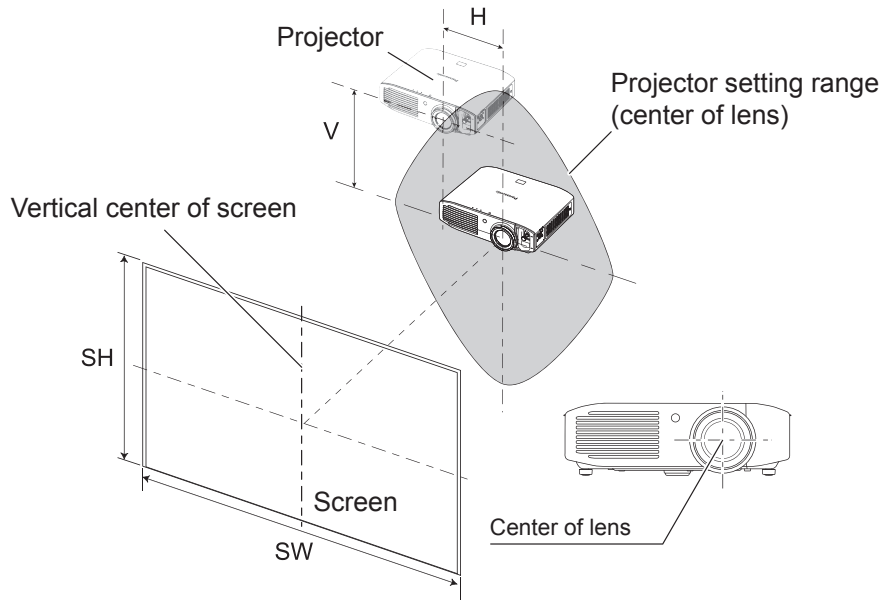

### ● Shift range of the projection screen when the projector position is fixed

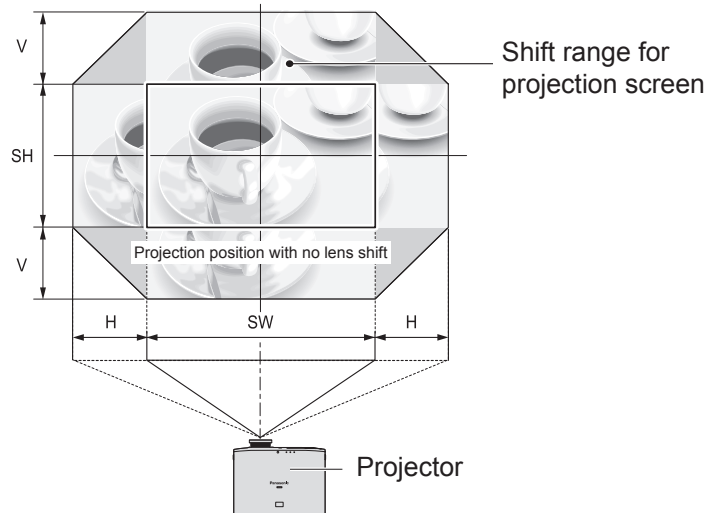

Shift direction	Maximum range of adjustment
Horizontal (H)	Approximately 26% of the projection screen width (SW)
Vertical (V)	Approximately 65% of the projection screen height (SH)

### Note

- Position the projector directly in front of the screen and move the lens shift lever to the center to obtain the optimum projection image quality.
- When the lens shift lever is at the horizontal limit of the shift range, you cannot move the lever to the vertical limit. Likewise, when the lens shift lever is at the vertical limit of the shift range, you cannot move the lever to the horizontal limit.
- Shift the lens position within the adjustment range. If you shift the lens position outside the adjustment range, a restriction is imposed on the lens movement to protect the optical components and the focus changes.
- If the projected image cannot be fit into the screen using the lens shift function alone, adjust the projection angle using the adjustable feet (➡ page 22), and then correct the keystone distortion using the [KEYSTONE] in the [POSITION] menu. (➡ page 58)

# Connections

## Before connecting to the projector

- Read and follow the operating and connecting instructions of each peripheral device.
- The peripheral devices must be turned off.
- If not provided or sold separately with each peripheral device, obtain the connection cables required for system connection in accordance with the device to be connected.
- If the video signal from the video source contains a lot of jitter, the image may appear to be wobble. In such cases, a time base corrector (TBC) must be connected.
- The signals that can be connected to the projector include VIDEO, S-VIDEO, analog-RGB (with TTL sync. level) and digital signal.
- Some computer models are not compatible with the projector.
- See "List of compatible signals" for the types of video signals that can be used with this projector. (▶ page 86)
- Audio cables must be connected from each external device directly to the audio reproduction system.

### Caution

When connecting to a computer or other equipment, use the power cord included with each device and a sealed, commercially available cable.

## Connecting example: COMPONENT IN/S-VIDEO IN/VIDEO IN

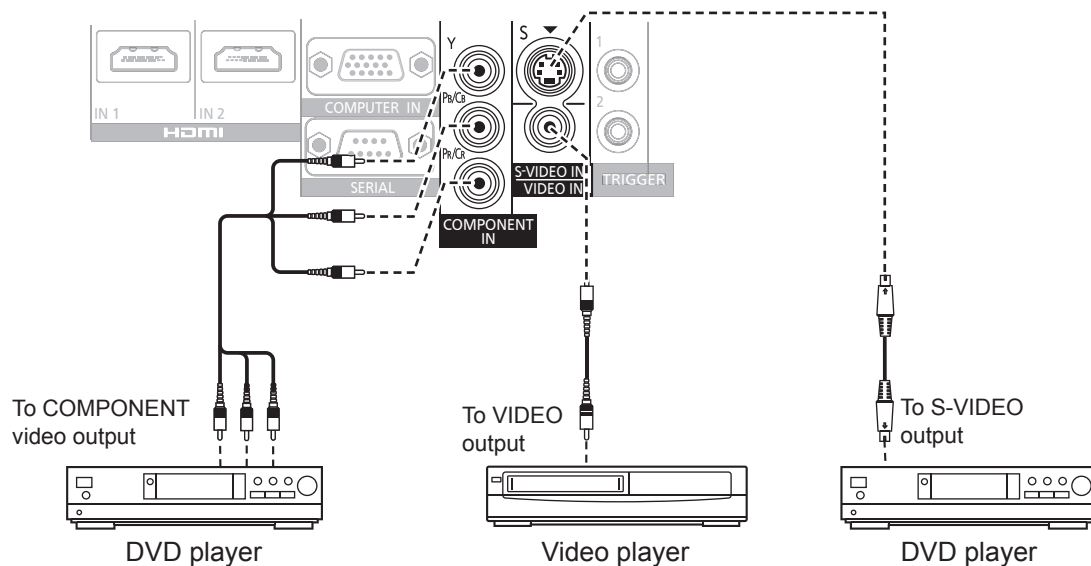

# Connections

## Connecting example: HDMI IN/COMPUTER IN

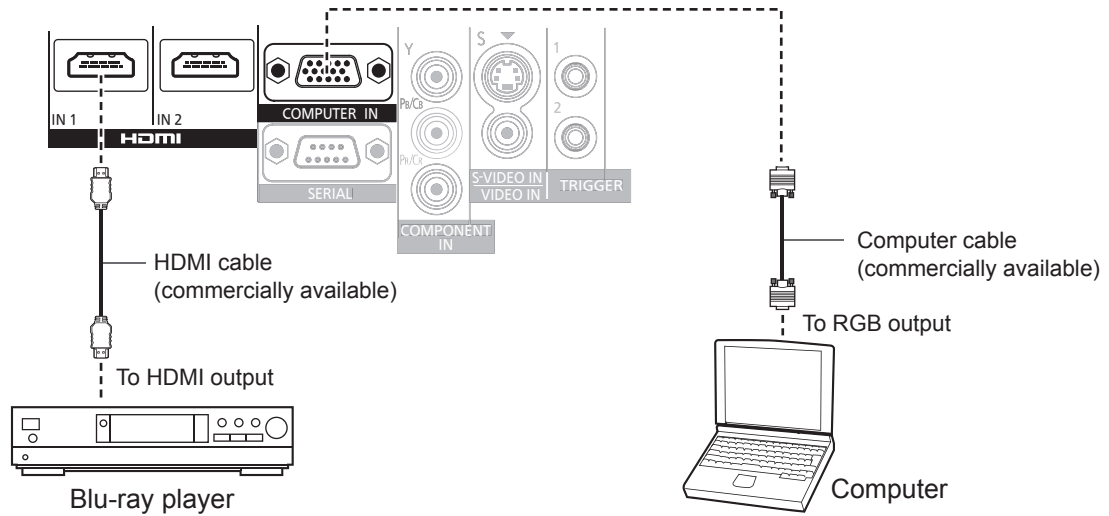

### Note

- Use an HDMI High Speed cable that conforms to HDMI standards. If a cable that does not meet HDMI standards is used, video may be interrupted or may not be displayed.
- It is possible to connect with DVI devices via an HDMI/DVI conversion adapter, but some devices may not project the image properly or other such problems could be encountered.
- When connecting to a serial terminal, see "Serial terminal". (▶ page 87)
- If you use a computer that has a resume function (last memory), you may have to reset the function so that it operates.

# Switching the projector on/off

## Power cord

Use the power cord included to prevent removal of the power cord and make sure it is fully inserted into the projector.

Make sure the <MAIN POWER> switch is on the <OFF> side before connecting the power cord.

Use the power cord included and ensure that it is fully inserted.

For power cord handling details, see "Read this first!". (▶ pages 6 to 12)

### ■ Connecting

Fully insert until the tabs on the left and right make a click sound.

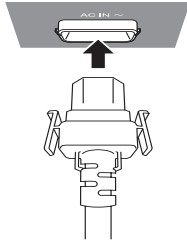

### ■ Disconnecting

Pull out while pushing on the tabs on the sides.

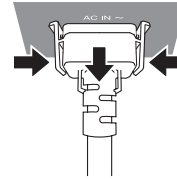

## Power indicator

The power indicator indicates the power status.

Check the status of the power indicator <ON (G) / STANDBY (R)> before operating the projector.

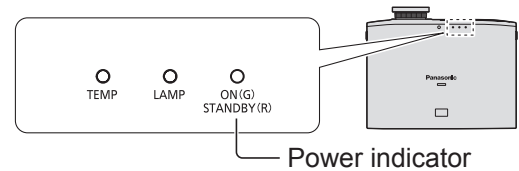

Indicator status		Status
No illumination or flashing		Main power is switched off.
Red	Lit	Power is switched off. (Standby mode.) Press the power <⏻ /   > button to start projection. * Does not operate when the lamp indicator or temperature indicator is flashing.
	Flashing	Power is switched off (standby mode) and the [POWER ON LINK] is set to [ON] in the VIERA Link settings. For details about [POWER ON LINK], see [POWER ON LINK] (▶ page 69).
Green	Flashing	The projector is preparing to project. Projection starts after a brief pause.
	Lit	Projecting.
Orange	Lit	Preparing to switch off the power. The power is switched off after a while. (Changes to the standby mode.)
	Flashing	The power <⏻ /   > button is switched on again in the power off preparation mode. Preparing to project. Projection starts after a brief pause.

# Switching the projector on/off

## Attention

- The internal fan operates and cools the projector while it is preparing to power off (when the power indicator is illuminated orange). Do not switch the main power off or remove the power cord.

## Note

- When the power <⏻ / | > button is pressed while the projector is in the power off preparation mode, it may take some time to enter projection mode.
- The projector consumes approx. 0.08 W of electrical power even when the power is off (when the power indicator is illuminated red).
- Power consumption when the power indicator flashes red is almost the same as when the lamp is illuminated red.

# Switching on the projector

Check external device connections before switching the projector on.

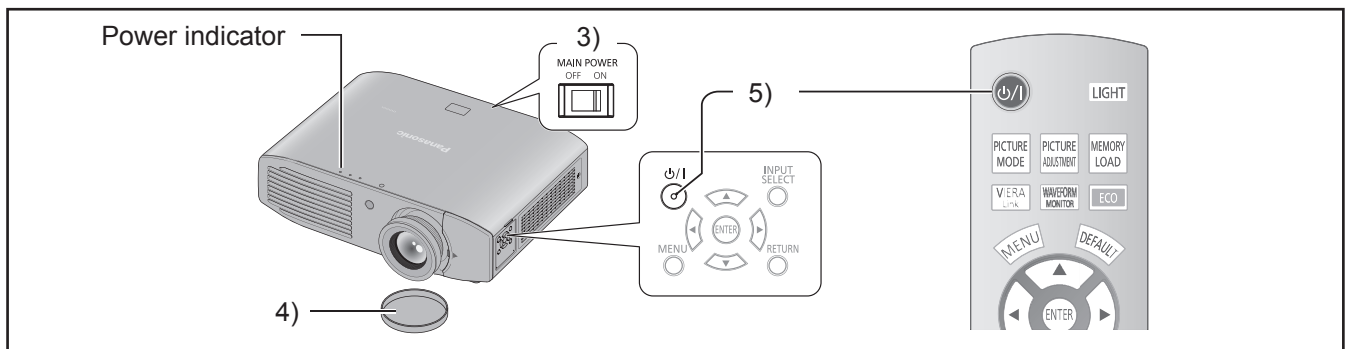

- 1) **Connect the power cord to the projector.**
- 2) **Connect the power plug to an outlet.**
- 3) **Press the <ON> side of the <MAIN POWER> switch to turn on the power.**
  - The power indicator illuminates or flashes red.
- 4) **Remove the lens cover.**
  - Be sure to remove the lens cover before starting projection.
- 5) **Press the power <⏻ / | > button.**
  - The power indicator illuminates green after flashing for a while and projection starts.

## Attention

- Using the projector while the lens cover is attached causes the device to heat up and can result in a fire.

## Note

- When starting up the projector, a small rattling sound may be heard or when the luminous lamp is lit a tinkling sound may be heard, but this is not a malfunction.
- During video projection, the cooling fan operates and makes a sound. This fan sound may change with ambient temperature and becomes louder when the lamp is turned on.
- Setting the [LAMP POWER] in the [OPTION] menu to [ECO] reduces operation sounds. (➔ page 66)
- When the lamp is turned off and immediately turned back on again, the video may temporarily flicker slightly at the start of projection due to lamp characteristics. This is not a malfunction.



# Switching the projector on/off

## Switching off the power

Carefully check the status of the power indicator before operating.

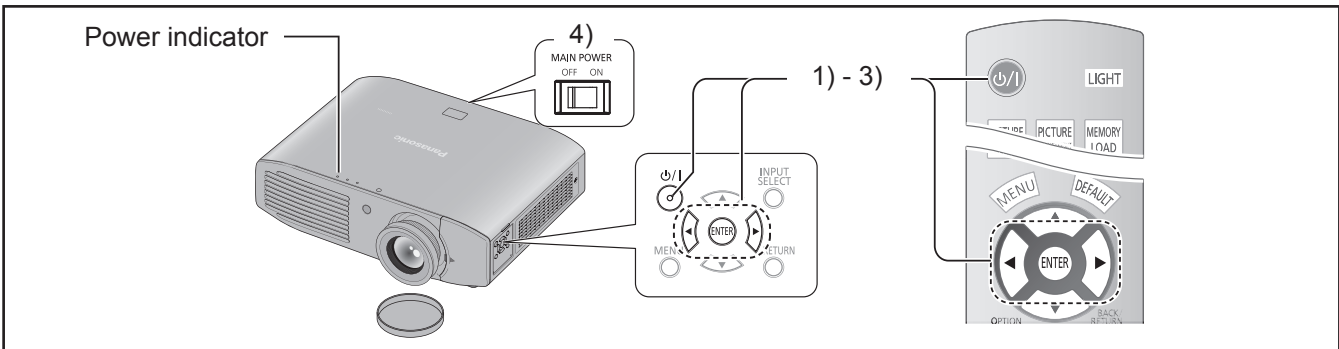

**1) Press the power <⏻ / | > button.**

- The confirmation message is displayed.

**2) Select [OK] with the ◀ ▶ buttons.**

**3) Press the <ENTER> button (or press the power <⏻ / | > button again).**

- The lamp extinguishes and video projection halts.
- The cooling fan continues to operate and the power indicator illuminates orange. Wait for the power indicator to turn red or start flashing red.

**4) Press the <OFF> side of the <MAIN POWER> switch to turn off the power.**

- Never switch off the main power or remove the power cord when the cooling fan is operating.

**Note**

- Select [CANCEL] or press the <MENU> or <RETURN> button to close the power off confirmation message.
- The power can also be switched off when the power <⏻ / | > button is held down for 0.5 seconds or more.

# Projecting an image

Check the connections of the external devices (➡ page 25) and the connection of the power cord (➡ page 27), and switch on the power (➡ page 28), to start projecting. Select the video for projection, and adjust appearance of the projected image.

## Selecting the input signal

### 1) Switch on the external devices.

- Press the play button on an external device, such as a Blu-ray player. When [AUTO SEARCH] in the [OPTION] menu is [ON], the projector automatically searches for an input signal and starts projection. (➡ page 64)

### 2) Switch the video input.

- The video selected with the <INPUT SELECT> button is projected. (➡ page 33)

#### Attention

- The video may not be displayed properly depending on the external device or the DVD being played back. In such cases, set [TV-SYSTEM], [RGB/YC<sub>B</sub>C<sub>R</sub>] or [RGB/YP<sub>B</sub>PR] of the [ADVANCED MENU]. (➡ page 52)
- Check the projection screen and video aspect ratio, and select the most appropriate aspect ratio with [ASPECT] in the [POSITION] menu. (➡ page 56)

## Adjusting the image

### 1) Adjust the angle of the projector.

- Place the projector parallel to the screen, and then install it on a flat surface so that the screen becomes rectangle.
- If the screen is tilted lower than the screen, extend the adjustable feet to make a rectangle screen.
- For details, see “Front adjustable feet and throwing angle”. (➡ page 22)

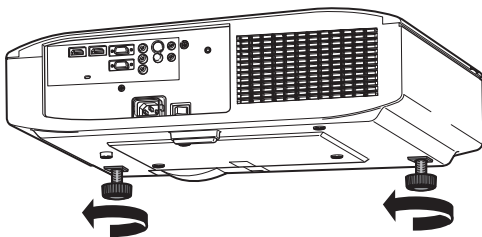

### 2) Remove the lens shift cover.

- For details, see “Opening the lens shift cover”. (➡ page 18)

### 3) Rotate the lens shift lever in a counterclockwise direction to disengage the shift lever lock.

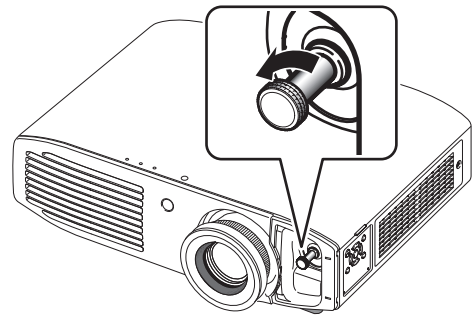

### 4) Adjust the lens shift.

- Adjust the projection position with the shift lever.

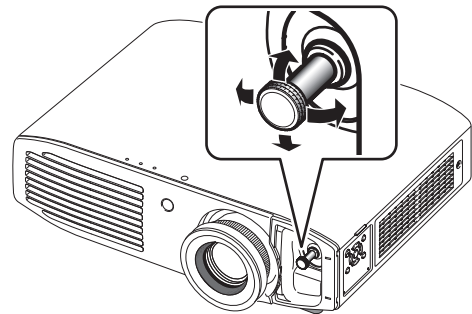

- See “Lens shift and positioning”. (➡ page 23)

### 5) Rotate the shift lever clockwise to fix.

### 6) Attach the lens shift cover.

### 7) Adjusting the zoom and focus.

- Turn zoom ring and focus ring to adjust.

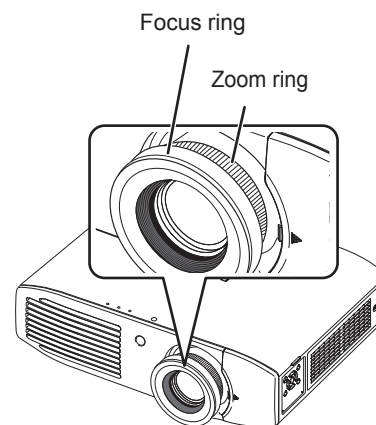

#### Note

- Panasonic recommends that focus adjustment be made after 30 minutes or more have elapsed since picture display.
- As the projection size changes if the focus ring is turned, turn the zoom ring to fine tune the projection size again.

# Remote control operation



You can operate the projector with the remote control within a range of 7 m (23').

## ● Operating by pointing at the projector

Ensure the remote control transmitter is facing the remote control signal receiver on the front of the projector during use.

## ● Facing to the screen

Ensure the remote control transmitter is facing the screen and press the required buttons to operate the projector. The signal will be reflected off the screen. The operating range may differ due to the screen material. This function may not be effective with a translucent screen.

### Note

- Do not let strong light shine onto the signal receiver. The remote control may malfunction under strong light such as fluorescent light.
- If there are any obstacles between the remote control and the remote control signal receiver, the remote control may not operate correctly.

## Illuminating button lights

You can illuminate the button lights on the remote control.

**Press** **LIGHT**

Press the <LIGHT> button again to extinguish the button lights.

### Note

- Button lights dim if no actions are carried out for approximately 5 seconds, and then extinguish if no actions are carried out for a further 5 seconds.
- After the button lights have automatically extinguished, they automatically illuminate again if any button is pressed. (If the <LIGHT> button is pressed within 10 seconds of illuminating, the button lights extinguish and do not automatically illuminate even if another button is pressed.)

## Selecting the picture mode

You can switch to your desired picture mode settings.

**Press** **PICTURE MODE**

The settings change as follows each time the button is pressed.

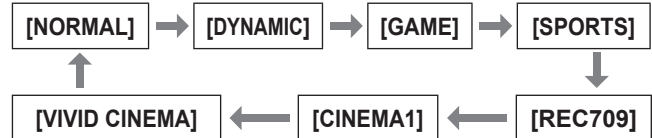

### Note

- You can also switch the picture mode settings using the on-screen menu. For details see [PICTURE MODE] in the [PICTURE] menu. (➡ page 37)

## Adjusting the picture

Switchable setting items from the [PICTURE] menu of the on-screen menu can be displayed in a list.

**Press** **PICTURE ADJUSTMENT**

Press the button to switch between [PICTURE] menu and [ADVANCED MENU] menu. Press ▲ ▼ to select the required menu item and ◀ ▶ to adjust.

- [PICTURE] menu items  
[PICTURE MODE], [CONTRAST], [BRIGHTNESS], [COLOUR], [TINT], [COLOUR TEMPERATURE], [SHARPNESS] and [DYNAMIC IRIS]
- [ADVANCED MENU] menu items  
[GAMMA HIGH], [GAMMA MID], [GAMMA LOW], [CONTRAST], [BRIGHTNESS], [NR], [MPEG NR], [MOTION EFFECT], [x.v.Colour], [DETAIL CLARITY], [CINEMA REALITY], [TV-SYSTEM], [RGB/YC<sub>B</sub>Cr] and [RGB/YP<sub>B</sub>Pr]

### Note

- For details regarding the adjustment method, see the [PICTURE] menu (➡ page 37) and the [ADVANCED MENU] menu (➡ page 42).
- Press the <RETURN> or <MENU> button or wait for 7 seconds without performing any operation to clear the adjustment screen.
- Set the [ADJUSTMENT MODE] to [SIMPLE] for adjusting [GAMMA HIGH], [GAMMA MID], and [GAMMA LOW] (➡ page 42).
- The items for [SHARPNESS] that can be adjusted differ depending on the [ADJUSTMENT MODE].  
[SIMPLE]: [SHARPNESS]  
[ADVANCED]: [H-SHARPNESS]  
[V-SHARPNESS]

# Remote control operation

## Loading a saved setting

Displays the [MEMORY LOAD] menu.

Press 

### Attention

- Setting can also be performed using the on-screen menu. For details, see [MEMORY LOAD] in the [PICTURE] menu. (➡ page 54)

## Displaying the [VIERA LINK MENU] menu

You can control some functions of the external device with this projector remote control.

Press 

### Note

- See “Using VIERA Link” for details. (➡ page 82)

## Displaying the waveform monitor

By displaying the input signal from a connected external device with a waveform, you can check if the video signal (luminance) level is set to a value within this projector’s recommended range, and can adjust it accordingly.

Press 

The settings change as follows each time the <ENTER> button is pressed.

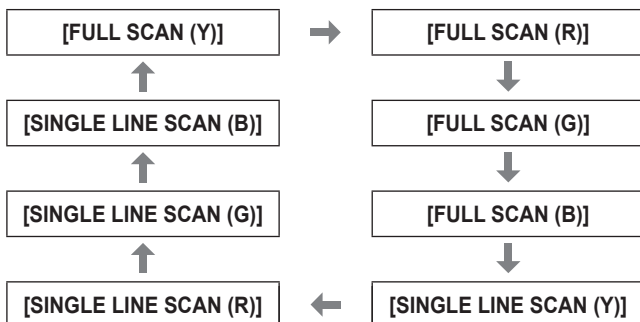

The waveform monitor disappears when the <WAVEFORM MONITOR> button is pressed again.

### Note

- Setting can also be performed using the on-screen menu. For details, see [WAVEFORM MONITOR] in [PICTURE] menu. (➡ page 39)

<b>[FULL SCAN]</b>	Checks that the waveform for each of the Y- (brightness), R- (red), G- (green), and B- (blue) values for the whole image is within the recommended range.
<b>[SINGLE LINE SCAN]</b>	Checks that the waveform for each of the Y- (brightness), R- (red), G- (green), and B- (blue) values for an arbitrary number of lines from the top of the screen to the bottom is within the recommended range. <ul style="list-style-type: none"> <li>● Enables more detailed confirmation than [FULL SCAN].</li> <li>● Line position can be changed with the ▲▼ buttons.</li> <li>● The display position of the [WAVEFORM MONITOR] changes depending on the line position.</li> </ul>

### Note

- Signals lower than 0 % in the waveform monitor will be displayed as same as 0 % on the projected image.
- [SINGLE LINE SCAN] can display horizontal lines in Y- (brightness), R- (red), G- (green), and B- (blue) from the top of the screen to the bottom more finely than [FULL SCAN], and each item can be adjusted in the same way as [FULL SCAN].
- When selecting [FULL SCAN], the display position of the waveform can be set using the ▲▼◀▶ buttons.
- So that the display of individual adjustment screen in [PICTURE] does not interfere with the waveform monitor, the positioning of this screen differs depending on the circumstances at the time.
- The [AUTO ADJUST] is executed by pressing the <DEFAULT> button while the waveform is displayed. (➡ page 39)
- While the waveform monitor is displayed, you cannot adjust the [COLOUR MANAGEMENT] settings.

## Resetting to the default settings

You can reset most of the settings or adjustment values for submenus to factory default settings.

Press 

For details, see “Navigating through the menu - Returning adjusted values to default settings” of “Menu navigation”. (➡ page 34)

## Submenu

When the VIERA Link control is enabled, the function menus of external devices can be displayed.

(➔ page 82)

Furthermore, points for a gamma adjustment can be altered. (➔ page 42)

Press **SUB MENU**

## Switching the input signal

The input for projection can be switched.

Press **INPUT SELECT**

The settings change as follows each time the button is pressed.

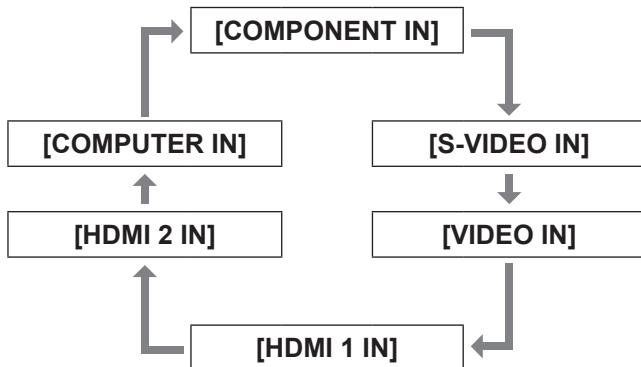

<b>[COMPONENT IN]</b>	COMPONENT signals (Y <sub>C</sub> B <sub>C</sub> R/ Y <sub>P</sub> B <sub>P</sub> R) from the device connected to COMPONENT IN.
<b>[S-VIDEO IN]</b>	S-VIDEO signal from the device connected to S-VIDEO IN.
<b>[VIDEO IN]</b>	VIDEO signal from the device connected to VIDEO IN.
<b>[HDMI 1/2 IN]</b>	HDMI signal from the device connected to HDMI IN 1/HDMI IN 2.
<b>[COMPUTER IN]</b>	RGB signal and COMPONENT signals (Y <sub>C</sub> B <sub>C</sub> R/ Y <sub>P</sub> B <sub>P</sub> R) from the device connected to COMPUTER IN.

When [INPUT GUIDE] on the [OPTION] menu is set to [DETAILED] (➔ page 63), graphical guidance will be displayed on the upper right of the projected image, and the currently selected input terminal can be checked. (The selected input method will be highlighted in yellow.)

Press the button several times or press ▲ ▼ ◀ ▶ to cycle through the input methods.

It may take time for the video to change after switching input.

### Attention

- Input a signal noted in the “List of compatible signals”. (➔ page 86)

### Note

- See “Connecting terminals” regarding input ports. (➔ page 19)
- If no operations are performed for approximately 3 seconds, the input guidance display automatically disappears.
- If a port that has no input is selected, the whole input port graphic flashes. This graphic is displayed until an input is present.

## Using the <FUNCTION> button

Functions used often can be allocated to the <FUNCTION> button on the remote control and this can be used as a short cut button.

Press **FUNCTION**

### ■ Allocating operations to the <FUNCTION> button

- 1) **Press the <MENU> button in the controls of the projector or on the remote control to display the menu items for allocation (main menu, submenu, or detailed menu).**
  - For how to use the on-screen menu, see “Navigating through the menu”. (➔ page 34)
- 2) **Hold the <FUNCTION> button on the remote control down for at least 3 seconds.**
  - After setup is complete the allocated menu items are displayed under the on-screen menu.

### Note

- While the menu is displayed, the projector does not operate even when the button is pressed.

## Displaying the [ECO MANAGEMENT] menu

The settings screen for ECO MANAGEMENT can be displayed. (➔ page 67)

Press **ECO**

# Menu navigation





## Navigating through the menu

### Operating procedure

Press 





1) Press the <MENU> button on the remote control or in the controls of the projector.

- The main menu is displayed.

PICTURE	PICTURE MODE	NORMAL	
	CONTRAST	 0	
POSITION	BRIGHTNESS	 0	
	COLOUR	 0	
	TINT	 0	
LANGUAGE	COLOUR TEMPERATURE	 0	
	SHARPNESS	SIMPLE	
OPTION	DYNAMIC IRIS	ON	
	LIGHT HARMONIZER		
	WAVEFORM MONITOR		
	SPLIT ADJUST		
	ADVANCED MENU		
	PICTURE MEMORY		

2) Press the ▲▼ buttons to select main menu items.

- Select the item to be adjusted from the 4 items [PICTURE], [POSITION], [LANGUAGE] and [OPTION]. The selected item is indicated with a yellow cursor, and the submenu is displayed on the right hand side.

PICTURE	H-POSITION	 0
	V-POSITION	 0
	ASPECT	16:9
POSITION	WSS	ON
	OVER SCAN	 0
LANGUAGE	KEYSTONE	 0
	SCREEN AREA MEMORY	
OPTION		

3) Press the <ENTER> button.

- The submenu is displayed, and submenu items become selectable.

4) Press the ▲▼ buttons to select the submenu item you wish to alter, then press the ◀▶ to switch settings/adjust.

- For items where the setting is switched or that have a bar scale, the menu screen disappears and only the selected item (individual adjustment screen) is displayed, as shown in the diagram below.

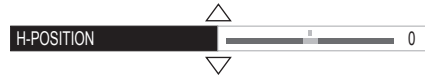

- For items that are only names, pressing the <ENTER> button displays the next screen and advanced settings can be performed.

### Note

- Pressing the <RETURN> or <MENU> button when the menu screen is displayed returns to the previous screen.
- Depending on the signal input, some items may not be adjustable and some functions may not be usable.
- Some items can be adjusted even if a signal is not input.
- See page 35 for the submenu items.

### Returning adjusted values to default settings

Press the <DEFAULT> button on the remote control to return the settings/adjustment values to default settings.

Press 

This function differs depending on the screen displayed.

- When the submenu screen is displayed: The submenu items displayed are returned to their default settings.
- When individual adjustment screen is displayed: Only the item currently being adjusted is returned to its default settings.



### Note

- All settings cannot be simultaneously returned to default settings.
- Some items do not return to default settings even you press the <DEFAULT> button. Please set those items individually.
- The vertical bar above the bar scale on the individual adjustment screen indicates the default setting. The position of the vertical bar varies depending on the input signal.

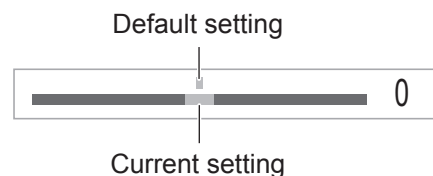



## Menu list

The on-screen menu is used for settings and adjustments on this projector.  
See "Navigating through the menu" for details of on-screen menu operation. (➔ page 34)  
The submenu of the main menu is displayed, and setting/adjustment for each item can be performed.

### ■ [PICTURE]

- S-VIDEO IN/VIDEO IN/COMPONENT (YCbCr/YPbPr) signal input/HDMI

Submenu items	Default setting	Page
[PICTURE MODE]	[NORMAL]	37
[CONTRAST]	[0]	37
[BRIGHTNESS]	[0]	37
[COLOUR]	[0]	37
[TINT]	[0]	37
[COLOUR TEMPERATURE]	[0]	38
[SHARPNESS]	[SIMPLE]	38
[DYNAMIC IRIS]	[ON]	38
[LIGHT HARMONIZER]	—	38
[WAVEFORM MONITOR]	—	39
[SPLIT ADJUST]	—	41
[ADVANCED MENU]	—	42
[PICTURE MEMORY]	—	53
SIGNAL MODE <sup>*1</sup>		54

\*1: COMPONENT IN/HDMI IN only

- COMPUTER (RGB) signal input

Submenu items	Default setting	Page
[PICTURE MODE]	[NORMAL]	37
[CONTRAST]	[0]	37
[BRIGHTNESS]	[0]	37
[COLOUR TEMPERATURE]	[0]	38
[SHARPNESS]	[SIMPLE]	38
[DYNAMIC IRIS]	[ON]	38
[LIGHT HARMONIZER]	—	38
[WAVEFORM MONITOR]	—	39
[SPLIT ADJUST]	—	41
[ADVANCED MENU]	—	42
[PICTURE MEMORY]	—	53
SIGNAL MODE		54

### ■ [POSITION]

- S-VIDEO IN/VIDEO IN

Submenu items	Default setting	Page
[H-POSITION]	[0]	55
[V-POSITION]	[0]	55
[ASPECT]	[AUTO]	56
[WSS] <sup>*1</sup>	[ON]	58
[OVER SCAN]	[+7]	58
[KEystone]	[0]	58
[SCREEN AREA MEMORY]	—	59

\*1: PAL signal input only

- COMPONENT IN/COMPUTER IN

Submenu items	Default setting	Page
[H-POSITION]	[0]	55
[V-POSITION]	[0]	55
[DOT CLOCK] <sup>*1</sup>	[0]	55
[CLOCK PHASE] <sup>*2</sup>	[0]	55
[ASPECT]	[16:9]	56
[WSS] <sup>*3</sup>	[ON]	58
[OVER SCAN] <sup>*4</sup>	[0]	58
[KEystone]	[0]	58
[AUTO SETUP] <sup>*5</sup>	—	58
[SCREEN AREA MEMORY]	—	59

\*1: COMPUTER IN only (exc. 480i, 576i, 480p, 576p)

\*2: Exc. 480i/576i

\*3: COMPONENT IN (576i, 576p) only

\*4: COMPONENT IN and COMPUTER signal (movie based signals) input only

\*5: COMPUTER IN (RGB) signals only (exc. movie based signals)

- HDMI IN

Submenu items	Default setting	Page
[H-POSITION]	[0]	55
[V-POSITION]	[0]	55
[ASPECT]	[16:9]	56
[OVER SCAN]	[0]	58
[KEystone]	[0]	58
[SCREEN AREA MEMORY]	—	59

#### Note

- The default settings may be different depending on the picture menu.

# Menu navigation

## ■ [LANGUAGE]

Language
[DEUTSCH]
[FRANÇAIS]
[ESPAÑOL]
[ITALIANO]
[PORTUGUÊS]
[SVENSKA]
[NORSK]
[DANSK]
[POLSKI]
[ČEŠTINA]
[MAGYAR]
[РУССКИЙ]
[ไทย]
[한국어]
[ENGLISH]
[中文]
[日本語]

## ■ [OPTION]

Submenu items	Default setting	Page
[ON-SCREEN DISPLAY]	—	63
[BACK COLOUR]	[BLUE]	63
[STARTUP LOGO]	[ON]	64
[AUTO SEARCH]	[ON]	64
[HDMI SIGNAL LEVEL] *1	[NORMAL]	64
[FRAME RESPONSE]	[NORMAL]	64
[PROJECTION METHOD]	[FRONT/DESK]	64
[TRIGGER 1 SETTING]	[OFF]	65
[TRIGGER 2 SETTING]	[OFF]	65
[HIGH ALTITUDE MODE]	[OFF]	66
[LAMP POWER]	[NORMAL]	66
[ECO MANAGEMENT]	—	67
[FUNCTION BUTTON]	—	68
[VIERA LINK SETTINGS]	—	68
[OTHER FUNCTIONS]	—	70
[TEST PATTERN]	—	70
[LAMP RUNTIME]	—	70

\*1: HDMI IN only

### Note

- Display of submenu items and default settings differs depending on the selected input port.



# [PICTURE] menu

Select [PICTURE] from the main menu of "Navigating through the menu" (➔ page 34), and choose an item from the submenu.

- After selecting an item, adjust the image with the ◀▶ buttons.

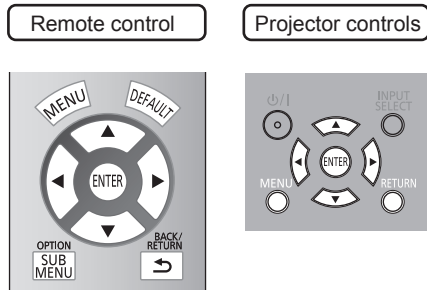

## [PICTURE MODE]

You can use these preset parameter settings to optimize image projection according to image source or projection environment.

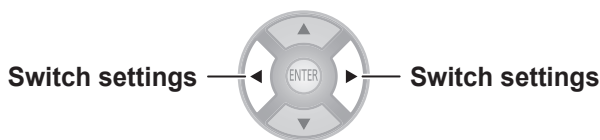

The settings change as follows each time the button is pressed.

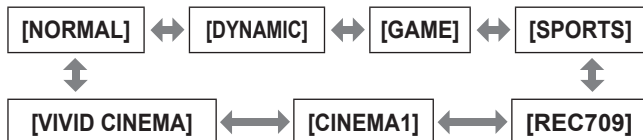

[NORMAL]	For a general image.
[DYNAMIC]	For viewing at high brightness and sharpness.
[GAME]	For use with games.
[SPORTS]	For sports program.
[REC709]	For HDTV standard (ITU-R BT. 709) color temperature 6 500 K at the default setting of the [PICTURE] menu items.
[CINEMA1]	Tuned by top Hollywood colorists for watching a movie with smooth image quality.
[VIVID CINEMA]	For use with a high luminance, clear picture mode.

### Note

- It may take a few seconds for the picture to stabilize after a picture mode change.

## [CONTRAST]

You can adjust the contrast of the colors.

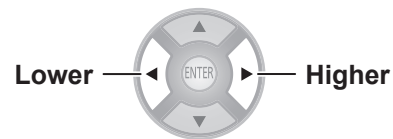

- Setting range: -64 to +64

### Attention

- Adjust the [BRIGHTNESS] in advance if necessary.

## [BRIGHTNESS]

You can adjust the dark (black) part of the projected image.

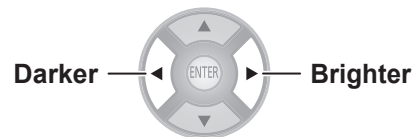

- Setting range: -32 to +32

## [COLOUR]

You can adjust the color saturation of the projected image.

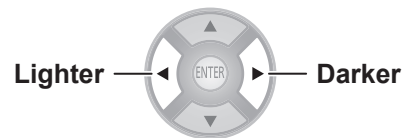

- Setting range: -32 to +32

### Note

- When COMPUTER signal is input, only movie based signals can be adjusted.
- Movie based signals are 480i, 576i, 480p, 576p, 720/60p, 720/50p, 1 080/60i, 1 080/50i, 1 080/60p, 1 080/50p and 1 080/24p.

## [TINT]

You can adjust the skin tone in the projected image.

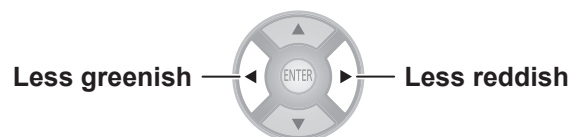

- Setting range: -32 to +32

### Note

- When COMPUTER signal is input, only movie based signals can be adjusted.
- Movie based signals are 480i, 576i, 480p, 576p, 720/60p, 720/50p, 1 080/60i, 1 080/50i, 1 080/60p, 1 080/50p and 1 080/24p.

# [PICTURE] menu

## [COLOUR TEMPERATURE]

You can adjust the color temperature if the white areas of the projected image are bluish or reddish.

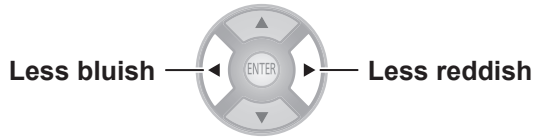

- Setting range: -6 to +6

## [SHARPNESS]

With regards to the input signal, adjust video sharpness using one of [SIMPLE] which adjusts horizontal direction and vertical direction simultaneously or [ADVANCED] which adjusts each individually.

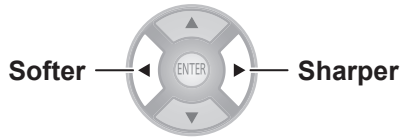

### Note

- Setting range will vary according to the selected input signal.
- [SHARPNESS] can be adjusted using either [SIMPLE] or [ADVANCED]. Both settings cannot be used at the same time.

- **Adjusting the [SHARPNESS].**  
(When [SIMPLE] is selected for the [ADJUSTMENT MODE].)

- 1) Press ◀▶ buttons to select [SIMPLE].

PICTURE		SHARPNESS
ADJUSTMENT MODE		SIMPLE
POSITION		SHARPNESS
		H-SHARPNESS
		V-SHARPNESS
LANGUAGE		

- 2) Select [SHARPNESS] with the ▲▼ buttons, and adjust with the ◀▶ buttons.

- **Adjusting the [SHARPNESS].**  
(When [ADVANCED] is selected for the [ADJUSTMENT MODE].)

- 1) Press the ◀▶ buttons to select [ADVANCED].

PICTURE		SHARPNESS
ADJUSTMENT MODE		ADVANCED
POSITION		H-SHARPNESS
		V-SHARPNESS
LANGUAGE		

- 2) Select item with the ▲▼ buttons, and adjust with the ◀▶ buttons.

- Pressing the ▲▼ buttons on the screen during adjustment switches to the [H-SHARPNESS] or [V-SHARPNESS] adjustment screen.

H-SHARPNESS		0
V-SHARPNESS		0

- The setting range varies according to the selected picture mode and input signal.

## [DYNAMIC IRIS]

You can switch automatic adjustment of the lamp and the lens iris on/off. This augments the video to create a video expression with sharp contrast between light and shade.

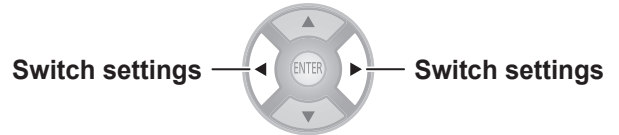

[ON]	Automatic adjustment
[OFF]	No adjustment

## [LIGHT HARMONIZER]

You can optimize the video according to the brightness and color of the surroundings.

PICTURE		LIGHT HARMONIZER
MODE		MANUAL
POSITION		MANUAL ADJUST
		0

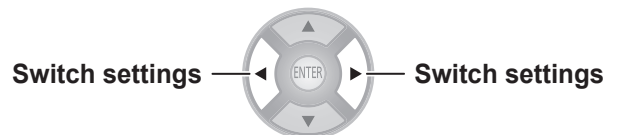

[AUTO]	Light harmonizer on (automatic augmentation). The color sensor detects the brightness of the surroundings and automatically augments the video display.
[MANUAL]	Light harmonizer on (manual setting). When [MANUAL] is selected, [MANUAL ADJUST] can be set using the ◀▶ buttons (setting range: 0 to +3).
[OFF]	Light harmonizer off.

### Note

- [AUTO] mode may not function correctly if an object is placed on the color sensor (▶ page 18) or the projector is placed in a recess.

## [WAVEFORM MONITOR]

By using a commercial test disk etc. and setting the luminance level of the output (brightness) signal from a connected external device to a value within this projector's recommended range, you can perform adjustment so the display performance of the projector can be fully leveraged.

### 1) Press the <ENTER> button.

- The [WAVEFORM MONITOR] menu is displayed.

WAVEFORM MONITOR	
● OFF	
FULL SCAN(Y)	
FULL SCAN(R)	
FULL SCAN(G)	
FULL SCAN(B)	
SINGLE LINE SCAN(Y)	
SINGLE LINE SCAN(R)	
SINGLE LINE SCAN(G)	
SINGLE LINE SCAN(B)	
MONITOR POSITION	UPPER LEFT
AUTO ADJUST	

### 2) Press the ▲ ▼ buttons to select the required item.

- The waveform monitor is displayed.
- Select [OFF] to close the waveform monitor.

### 3) Press the <ENTER> button.

#### Note

- For details, see "Displaying the waveform monitor" in "Remote control operation". (➡ page 32)

## [MONITOR POSITION]

You can set the display position of the input waveform during the FULL SCAN display.

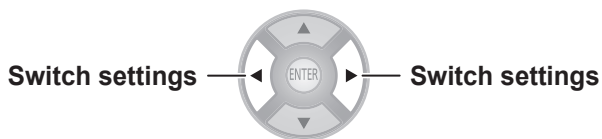

## [AUTO ADJUST]

The luminance level of the output signal from a connected external device is automatically adjusted by setting the automatic waveform adjustment items.

### 1) Press the <ENTER> button.

### 2) Press the ▲ ▼ buttons to select the required item.

Automatic waveform adjustment items	Default setting
[BLACK LEVEL ADJUST]	[ON]
[WHITE LEVEL ADJUST]	[ON]
[RGB ADJUST (BLACK)]	[OFF]
[RGB ADJUST (WHITE)]	[OFF]

### 3) Press the ◀ ▶ buttons to switch adjustment.

### 4) Press the ▲ ▼ buttons to select [START AUTO ADJUST] and press the <ENTER> button.

- [PROCESSING] message is displayed. When adjustment is complete, a confirmation message for applying results is displayed.

### 5) Select [OK] with the ◀ ▶ buttons.

### 6) Press the <ENTER> button.

#### Note

- When [BLACK LEVEL ADJUST] is [ON], the display signal Y (brightness) value's black level is automatically adjusted to the 0% position.
- When [WHITE LEVEL ADJUST] is [ON], the display signal Y (brightness) value's white level is automatically adjusted to the 100% position.
- When [RGB ADJUST (BLACK)] is [ON], the display signal R (Red), G (Green), and B (Blue) value's black level are all automatically adjusted to the 0% position.
- When [RGB ADJUST (WHITE)] is [ON], the display signal R (Red), G (Green), and B (Blue) value's white level are all automatically adjusted to the 100% position.
- [AUTO ADJUST] cannot be executed if the [WAVEFORM MONITOR] is [OFF].
- Project the luminance adjustment signal of a commercial test disk etc., and perform automatic adjustment. However, even with an adjustment disk, correct adjustment may not be possible if noise is included on the disk itself or the playback device generates noise.
- [AUTO ADJUST] adjusts based on the 0% and 100% standard signal within the screen, so correct adjustment cannot be performed if standard signals are not displayed on the screen because of overscan etc., or if a signal that is less than 0% or greater than 100% is displayed on the screen.

# [PICTURE] menu

## Adjust the waveform

Project the brightness adjustment signal of a commercial test disk (0% [0 IRE or 7.5 IRE] - 100% [100 IRE] ) and perform adjustment.

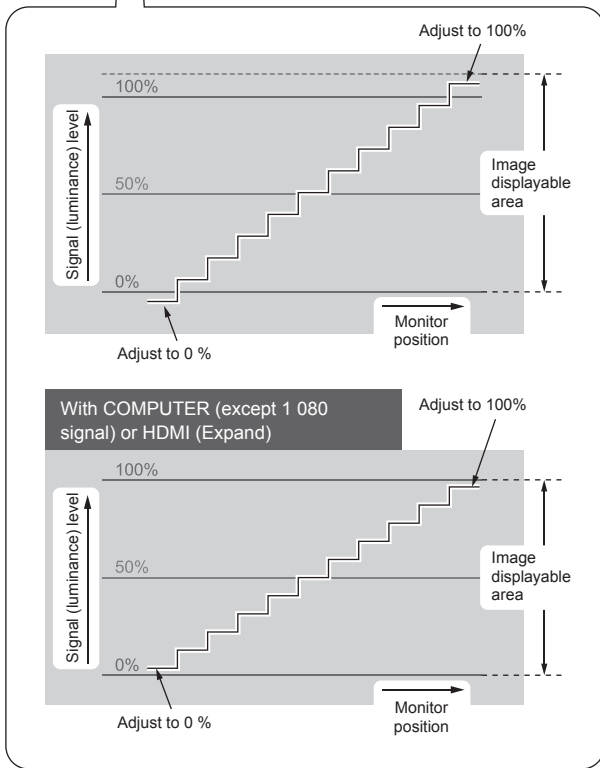
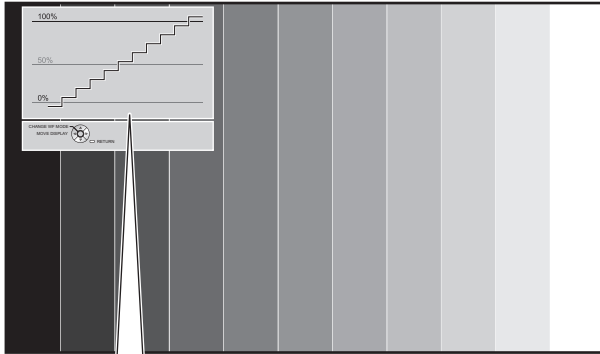

With the [WAVEFORM MONITOR] displayed, press the <MENU> button on the remote control and adjust using [ADVANCED MENU] and [PICTURE] from the on-screen menu.

### 1) Adjust [FULL SCAN(Y)] / [SINGLE LINE SCAN(Y)].

- Set on [PICTURE] and use the ◀▶ buttons to adjust [BRIGHTNESS] and then [CONTRAST].

[BRIGHTNESS]	Adjust the bottom line of the waveform to 0 % (0 or 7.5 IRE) ● Setting range: -32 to +32
[CONTRAST]	Adjust the top line of the waveform to 100 % (100 IRE) ● Setting range: -64 to +64

### 2) Adjust [FULL SCAN(R)] / [SINGLE LINE SCAN(R)].

- Set on [ADVANCED MENU] and use the ◀▶ buttons to adjust [BRIGHTNESS R] and then [CONTRAST R].

[BRIGHTNESS R]	Adjust the bottom line of the waveform to 0 % (0 or 7.5 IRE) ● Setting range: -16 to +16
[CONTRAST R]	Adjust the top line of the waveform to 100 % (100 IRE) ● Setting range: -32 to +32

### 3) Adjust [FULL SCAN(G)] / [SINGLE LINE SCAN(G)].

- Set on [ADVANCED MENU] and use the ◀▶ buttons to adjust [BRIGHTNESS G] and then [CONTRAST G].

[BRIGHTNESS G]	Adjust the bottom line of the waveform to 0 % (0 or 7.5 IRE) ● Setting range: -16 to +16
[CONTRAST G]	Adjust the top line of the waveform to 100 % (100 IRE) ● Setting range: -32 to +32

## 4) Adjust [FULL SCAN(B)] / [SINGLE LINE SCAN(B)].

- Set on [ADVANCED MENU] and use the ◀▶ buttons to adjust [BRIGHTNESS B] and then [CONTRAST B].

[BRIGHTNESS B]	Adjust the bottom line of the waveform to 0 % (0 or 7.5 IRE) ● Setting range: -16 to +16
[CONTRAST B]	Adjust the top line of the waveform to 100 % (100 IRE) ● Setting range: -32 to +32

## [SPLIT ADJUST]

You can perform image adjustment for some [PICTURE] menu items while displaying a certain area of the frozen image in a split window.

### 1) Press the <ENTER> button.

- The [SPLIT ADJUST] menu is displayed.

	PICTURE	SPLIT ADJUST	
	POSITION	AREA SELECT	
	LANGUAGE	SPLIT ADJUST MODE	NORMAL

### 2) Press the ▲▼ buttons to select [AREA SELECT] and then press the <ENTER> button.

- The image is frozen and an area for adjustment is displayed. The image being projected is recorded and displayed as a frozen image.

### 3) Use the ◀▶ buttons to select the area to be adjusted.

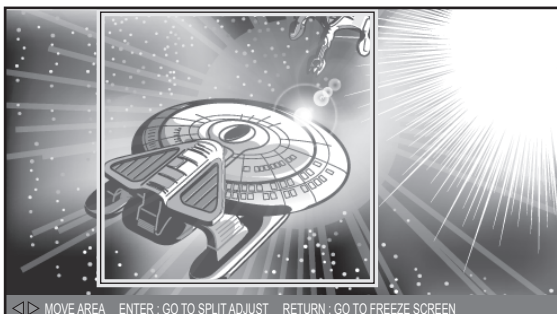

#### Note

- Press the <RETURN> button, and a frozen screen is displayed.

### 4) Press the <ENTER> button.

- Split screen display begins.

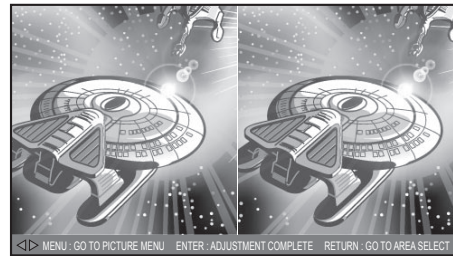

[When [SPLIT ADJUST MODE] is [NORMAL]]

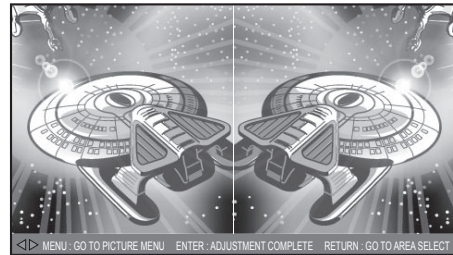

[When [SPLIT ADJUST MODE] is [REVERSE]]

#### Note

- By selecting the [SPLIT ADJUST MODE] with the ▲▼ buttons and switching [NORMAL] to [REVERSE], the screen displayed on the left during split screen display can be reversed and adjusted.

### 5) Press the <MENU> button and make adjustments with the [PICTURE] menu.

- The menu screen is displayed. You can adjust the image for optimal display.

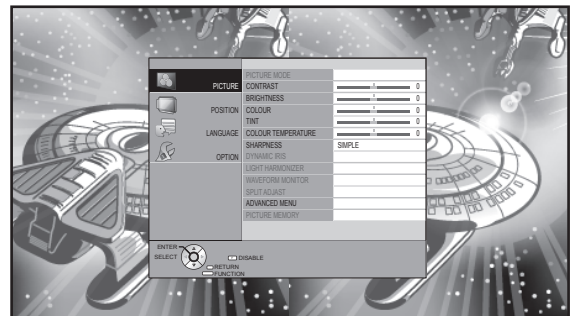

- Items that can be adjusted

Submenu items	Page
[CONTRAST]	37
[BRIGHTNESS]	37
[COLOUR]	37
[TINT]	37
[COLOUR TEMPERATURE]	38
[SHARPNESS]	38
[ADVANCED MENU]	42

### 6) Press the <RETURN> button until getting back to the adjustment screen.

## [PICTURE] menu

### 7) Press the <ENTER> button.

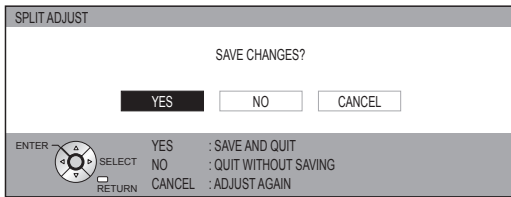

- The confirmation message is displayed. Select [YES] with the ◀▶ buttons and press the <ENTER> button to apply the changes and return to the frozen screen. Select [NO] with the ◀▶ buttons and press the <ENTER> button to return to the frozen screen without applying changes.

#### Note

- Select [CANCEL] on the confirmation message and press the <ENTER> button to return to the adjustment screen.

### 8) Press the <RETURN> button.

- You can now view the projected video with the adjustments applied.

#### Note

- You cannot adjust menu items that are displayed in grey during split adjustment.
- The [KEYSTONE] of [POSITION] becomes inactive during split adjustment.

## [ADVANCED MENU]

You can perform more detailed image adjustment manually.

### Press the <ENTER> button.

- The [ADVANCED MENU] menu is displayed.

### [GAMMA ADJUSTMENT]

You can make detailed adjustments to the light intensity of each input signal level by using the [ADVANCED] mode, or adjust at 3 levels (high, mid, low) by using the [SIMPLE] mode.

#### Note

- You can only carry out the [GAMMA ADJUSTMENT] through either the [ADVANCED] or [SIMPLE] mode. Both settings cannot be used at the same time.

### ● Adjusting the gamma (when [ADVANCED] is selected for [ADJUSTMENT MODE])

#### 1) Press the ◀▶ buttons to select [ADVANCED].

		GAMMA ADJUSTMENT	
	PICTURE	ADJUSTMENT MODE	ADVANCED
		GAMMA HIGH	
	POSITION	GAMMA MID	
		GAMMA LOW	
	LANGUAGE	POINT	5
		Y ADJUST	
	OPTION	R ADJUST	
		G ADJUST	
		B ADJUST	
		INITIALIZE	



2) Press the ▲▼ buttons to select [Y ADJUST] and then press the <ENTER> button.

- The [Y ADJUST] menu is displayed and a maximum of 9 points are adjustable.

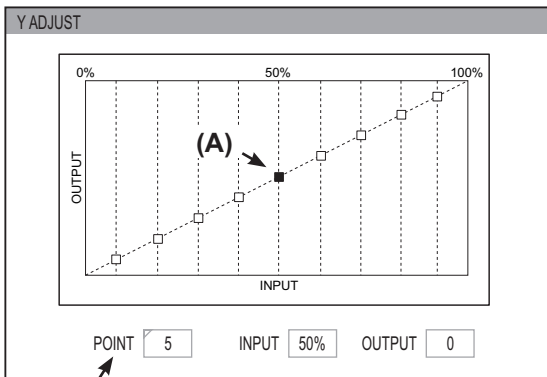

Displays information about the current selected point (A).

Default setting:

POINT [5] INPUT [50 %] OUTPUT [0]

3) Adjust the tone with the ▲▼◀▶ buttons, <ENTER> button, <SUB MENU> button, or <DEFAULT> button.

a. Changing the selected point

- Using the remote control

The selection point moves one point to the right each time the <SUB MENU> button is pressed. The default setting is point 5.

Ex. 5 -> 6 -> ... -> 9 -> 1 -> ...

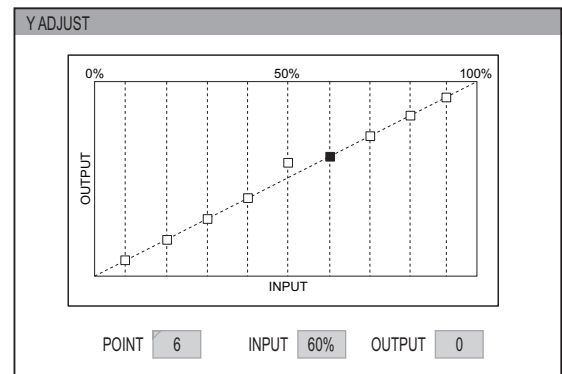
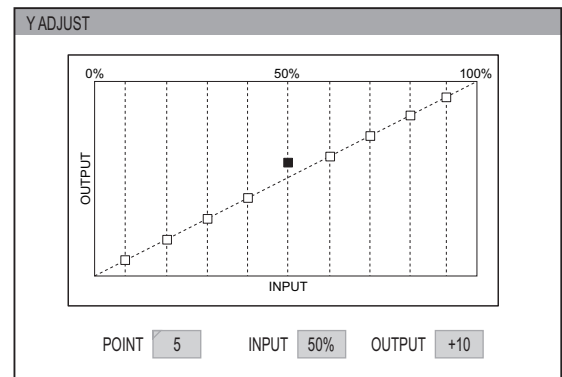

[POINT] [1] to [9]	Display the present selected point number. Numbers 1 to 9 are displayed from the left of the input signal level. Your selected point is indicated in yellow on the graph.
[INPUT] [1 %] to [99 %]	Display the input level of the present selected point. Setting range: from 1 to 99 % in increments of 1 %. Default settings: 10, 20, 30, 40, 50, 60, 70, 80, 90 %
[OUTPUT] [-252] to [+252]	Display the output level of the present selected point. Adjustable range depends on the input level. Default setting: 0

- Using the device control

You can also change the [POINT] from the [GAMMA ADJUSTMENT] menu directly.

Use ▲ ▼ to select [POINT] and ◀ ▶ to change the point.

PICTURE	GAMMA ADJUSTMENT	
	ADJUSTMENT MODE	ADVANCED
POSITION	GAMMA HIGH	
	GAMMA MID	
	GAMMA LOW	
LANGUAGE	POINT	5
OPTION	Y ADJUST	
	R ADJUST	

PICTURE	GAMMA ADJUSTMENT	
	ADJUSTMENT MODE	ADVANCED
POSITION	GAMMA HIGH	
	GAMMA MID	
	GAMMA LOW	
LANGUAGE	POINT	6
OPTION	Y ADJUST	
	R ADJUST	

## [PICTURE] menu

### b. Adjusting the input level

- To adjust the input level from the present setting, press ◀▶ continuously until it reaches your desired level. (It may be moved left and right.)
  - Setting range: from 1 to 99 % in increments of 1 %. (However, it cannot be set beyond the adjacent points.)
  - Only available to adjust the input level in the [Y ADJUST] screen and not other screens. (Input level cannot be adjusted on the [R/G/B ADJUST] screen.)

Ex. Press ◀ in the [Y ADJUST] screen and move the selected point leftward.

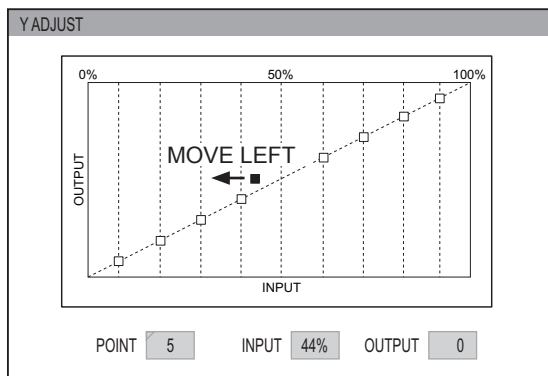
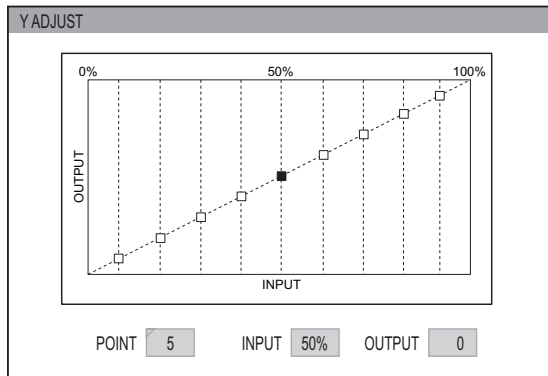

Setting range: 1 to 99 %

### c. Adjusting the output level

- To adjust the output level from the present setting, press ▲▼ continuously until it reaches to your desired level. (It may be moved up and down.)
  - Output level can be adjusted for each color on the [R/G/B ADJUST] screen.

Ex. Press ▲ in the [Y ADJUST] screen and move the selected point upward.

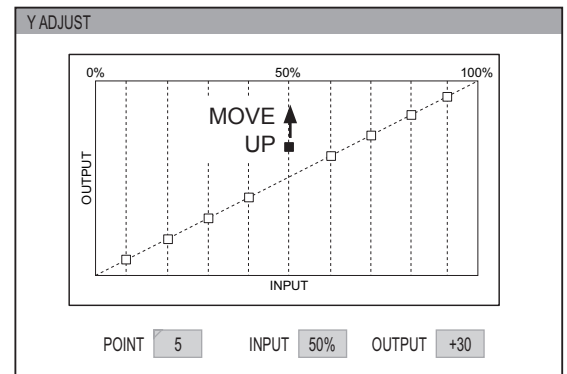
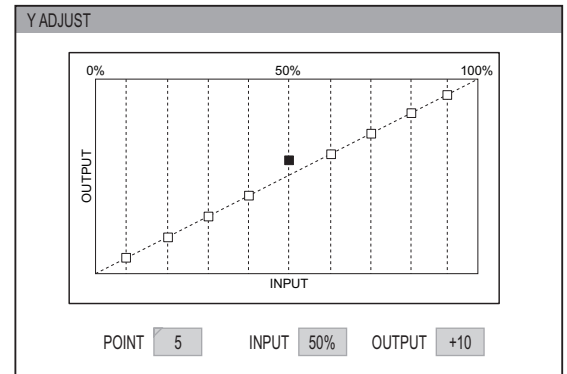

Setting range: -252 to +252



## d. Changing the adjustment by different color types

- The settings change as follows each time the <ENTER> button is pressed.

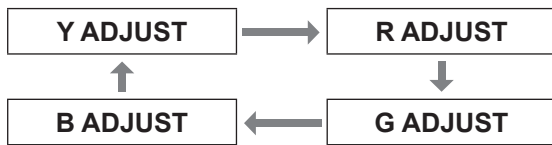

You can also switch each different color adjustment menu through the [GAMMA ADJUSTMENT] menu. Select your required color adjustment ([Y ADJUST], [R ADJUST], [G ADJUST], [B ADJUST]) with ▲ ▼ in the [GAMMA ADJUSTMENT] menu and press the <ENTER> button.

PICTURE	GAMMA ADJUSTMENT	
	ADJUSTMENT MODE	ADVANCED
POSITION	GAMMA HIGH	
	GAMMA MID	
	GAMMA LOW	
LANGUAGE	POINT	5
	OPTION	
	Y ADJUST	
	<b>R ADJUST</b>	
	G ADJUST	
	B ADJUST	
	INITIALIZE	

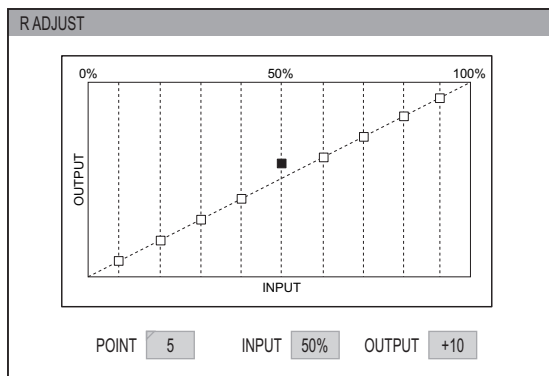

## e. Setting the output levels back to the default setting

- To set the output level on the selected point back to the default setting "0", press the <DEFAULT> button on the remote control.

### Note

- Individual input levels cannot be set back to their default settings by pressing the <DEFAULT> button. Press ◀▶ to move back themselves if needed.

## Initialize the gamma adjustment results

PICTURE	GAMMA ADJUSTMENT	
	ADJUSTMENT MODE	ADVANCED
POSITION	GAMMA HIGH	
	GAMMA MID	
	GAMMA LOW	
LANGUAGE	POINT	5
	OPTION	
	Y ADJUST	
	R ADJUST	
	G ADJUST	
	B ADJUST	
	<b>INITIALIZE</b>	

- Press the ▲ ▼ buttons to select [INITIALIZE] and press the <ENTER> button.

- The confirmation message is displayed for the gamma initialization.

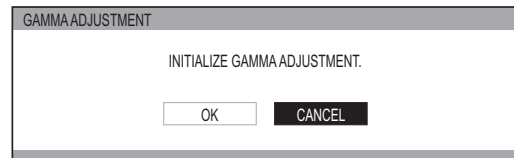

- Select [OK] with the ◀▶ buttons and press the <ENTER> button.

- Your gamma settings in [ADVANCED] mode will return to factory default settings.

### Note

- Initialization is not available in [SIMPLE] mode.

# [PICTURE] menu

## ● Adjusting the gamma (when [SIMPLE] is selected for [ADJUSTMENT MODE])

1) Press the ◀▶ buttons to select [SIMPLE].

PICTURE		GAMMA ADJUSTMENT
PICTURE	ADJUSTMENT MODE	SIMPLE
POSITION	GAMMA HIGH	0
LANGUAGE	GAMMA MID	0
OPTION	GAMMA LOW	0
	POINT	
	Y ADJUST	
	R ADJUST	

2) Select item with the ▲▼ buttons, and adjust with the ◀▶ buttons.

- You can adjust linear intensity at 3 levels (high, mid, low). Press ▲ ▼ to select your required gamma levels.

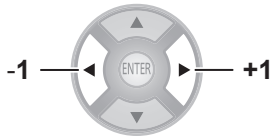

GAMMA HIGH	0
GAMMA MID	0
GAMMA LOW	0

[ADVANCED MENU] menu items	Default setting
[GAMMA HIGH]	0
[GAMMA MID]	0
[GAMMA LOW]	0

- Setting range: -8 to +8

## ■ [CONTRAST]

You can adjust color temperatures centring mainly on white.  
R (RED), G (GREEN), B (BLUE)

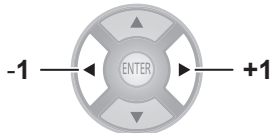

[ADVANCED MENU] menu items	Default setting
[CONTRAST R]	0
[CONTRAST G]	0
[CONTRAST B]	0

- Setting range: -32 to +32

## ■ [BRIGHTNESS]

You can adjust color temperatures centring mainly on black.  
R (RED), G (GREEN), B (BLUE)

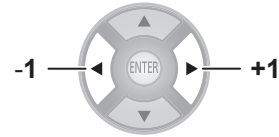

[ADVANCED MENU] menu items	Default setting
[BRIGHTNESS R]	0
[BRIGHTNESS G]	0
[BRIGHTNESS B]	0

- Setting range: -16 to +16

## ■ [NR]

You can eliminate the noise that occurs when the input signal deteriorates.

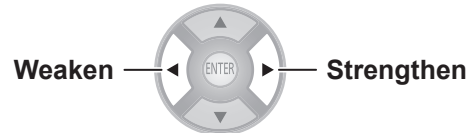

- Setting range: 0 to +3

## ■ [MPEG NR]

You can eliminate the noise that occurs upon projection for videos that use MPEG compression.

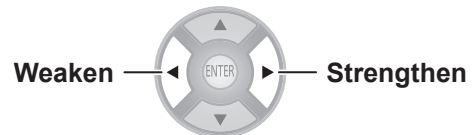

- Setting range: 0 to +3

### Attention

- Use a strong setting when projecting an MPEG video.
- COMPUTER (RGB) signal is not supported.

## ■ [MOTION EFFECT]

Videos with a lot of movement can also be viewed sharply.

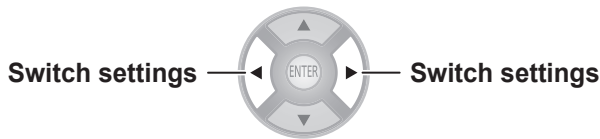

[OFF]	MOTION EFFECT inactive
[ON]	MOTION EFFECT active

### Note

- The effect on the video may be difficult to see in some cases.

## ■ [COLOUR MANAGEMENT]

For the selected [PICTURE MODE], you can adjust a selected color individually with [CURSOR] mode or adjust the six color components (Red, Green, Blue, Cyan, Magenta, Yellow) with [RGBCMY] mode.

Adjustment results can be saved as a profile and called later.

## ● Create a new profile

### Note

- [COLOUR MANAGEMENT] will be unable to adjust with the setting of [REC709] in [PICTURE MODE], when HDMI signal is selected.
- When the input signal is switched while adjusting, adjustment details are not saved.
- If there is another area, which has the exact same or similar color as the target on the same screen, these colors will be adjusted as well.
- You can adjust all colors except white, gray and black.
- If you edit a single color to be individual different colors, the desired color may not be achieved.

## ● Adjusting the selected color (when [CURSOR] is selected for [ADJUSTMENT MODE])

Select the desired color with a cursor and adjust.

- 1) Press the ◀▶ buttons to select [CURSOR] in [ADJUSTMENT MODE].

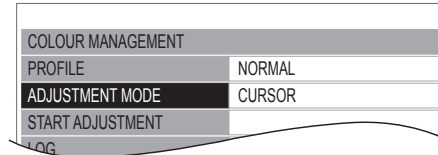

- 2) Press the ▲▼ buttons to select [START ADJUSTMENT] and press the <ENTER> button.

- The cross cursor (A) is displayed, and the projected image is captured.

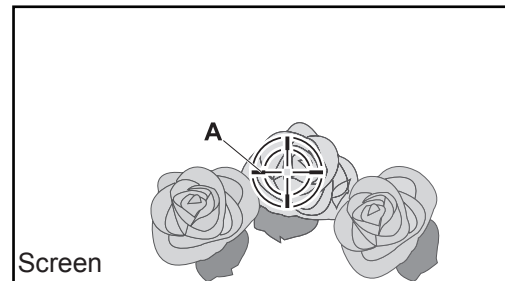

- 3) Move the cursor with the ▲▼◀▶ buttons to the required place to select a color.

- Align the center of the cross cursor on the point in the projected image to be adjusted.

- 4) Press the <ENTER> button.

- [CURSOR] menu (B) and the color selected (C) are displayed.

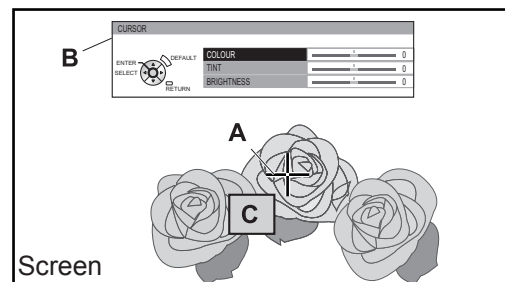

### Note

- In some cases you may be unable to adjust when the very edge point of the projection area is selected.
- You can create a profile only when [ADJUSTMENT MODE] is set to either [CURSOR] or [RGBCMY]. A profile cannot be created from both adjustments.
- White, gray and black cannot be edited.

## [PICTURE] menu

- 5) Press the ▲▼ buttons to select a menu item and the ◀▶ buttons to adjust each item level.

[COLOUR]	Adjust the vividness of the color. ● Setting range: -30 to +30
[TINT]	Adjust the color tone. ● Setting range: -30 to +30
[BRIGHTNESS]	Adjust the brightness of the color. ● Setting range: -20 to +20

- The default setting for each item is [0]. After adjusting, the post-adjustment color (D) is displayed.

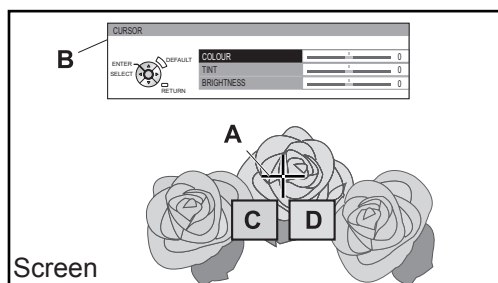

- 6) Press the <ENTER> button.

- [PROCESSING] message is displayed for a few seconds and the result is stored in [LOG]. You can store up to 8 logs under [LOG]. Press the <RETURN> or <MENU> button to adjust the other colors. Repeat from step 3) to store more adjustments.

- 7) Press the <RETURN> button or <MENU> button twice.

- This returns you to the [COLOUR MANAGEMENT] menu.

- Adjusting the selected color (when [RGBCMY] is selected for [ADJUSTMENT MODE])

Select the color from 6 different color types ([RED], [GREEN], [BLUE], [CYAN], [MAGENTA], [YELLOW]) and adjust [COLOUR], [TINT] and [BRIGHTNESS].

- 1) Press the ◀▶ buttons to select [RGBCMY] in [ADJUSTMENT MODE].

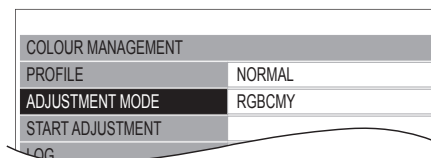

- 2) Press the ▲▼ buttons to select [START ADJUSTMENT] and press the <ENTER> button.

- 3) Press the ▲▼ buttons to select your desired color and press the <ENTER> button.

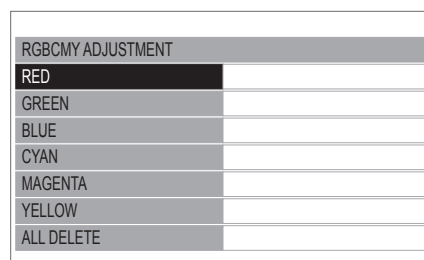

- Menu (B) and the base color (C) is displayed.

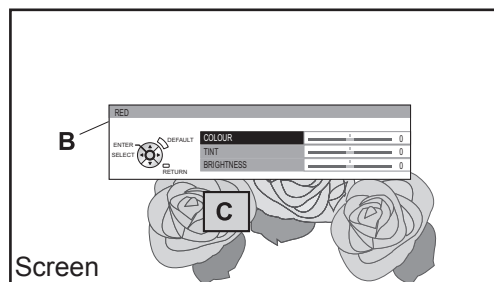

- 4) Press the ▲▼ buttons to select a menu item and the ◀▶ buttons to adjust each item level.

[COLOUR]	Adjust the vividness of the color. ● Setting range: -30 to +30
[TINT]	Adjust the color tone. ● Setting range: -30 to +30
[BRIGHTNESS]	Adjust the brightness of the color. ● Setting range: -20 to +20

- The default setting for each item is [0]. After adjusting, the post-adjustment color (D) is displayed.

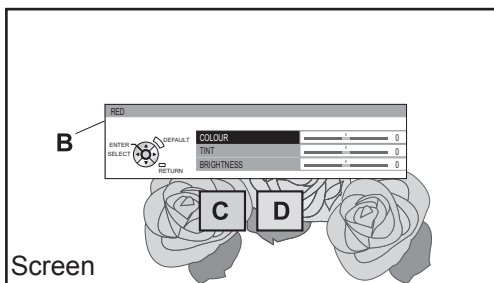

- 5) Press the <ENTER> button.
- [PROCESSING] message is displayed for a few seconds and the result is stored in [LOG]. You can store up to 6 different color adjusted images under [LOG]. Press the <RETURN> button to adjust the other colors. Repeat from step 3) to store more adjustments.
- 6) Press the <RETURN> button or <MENU> button twice.
- This returns you to the [COLOUR MANAGEMENT] menu.

### Note

- Base color (C) and post-adjustment color (D) (displayed when [ADJUSTMENT MODE] is set to [RGB/CMY]), are intended to be guide colors only.

## ● Editing/deleting logs

You can edit or delete stored logs.

Press the ▲▼ buttons to select [LOG] and press the <ENTER> button.

- The [LOG] menu is displayed.

- Managing the stored logs created through the [CURSOR] mode

LOG				
ADJUSTMENT MODE	:	CURSOR		
PICTURE MODE	:	NORMAL		
		COLOUR	TINT	BRIGHTNESS
POINT1		+10	+10	+10
POINT2		+10	+10	+10
POINT3		+10	+10	+10
POINT4		+10	+10	+10
POINT5		+10	+10	+10
POINT6		+10	+10	+10
POINT7		+10	+10	+10
POINT8		+10	+10	+10
ALL DELETE				

Selected color  Adjusted color 

[POINT] [1] - [8]	<p>Press ▲ ▼ to select the point you wish to edit, and press the &lt;ENTER&gt; button to display the screen to select [CHANGE] or [DELETE].</p> <p>[CHANGE]: The [CURSOR] menu is displayed and you can readjust the color.</p> <p>[DELETE]: Deletes point adjustment data.</p> <p>Press the &lt;ENTER&gt; button to display a confirmation message.</p> <p>Select [OK] with the ◀▶ buttons and press the &lt;ENTER&gt; button to delete.</p>
[ALL DELETE]	<p>When [ALL DELETE] is selected using the ▲▼ buttons and &lt;ENTER&gt; is pressed, a confirmation message is displayed.</p> <p>Select [OK] with the ◀▶ buttons and press the &lt;ENTER&gt; button to delete all logs. The [PROFILE] setting will be set to [NORMAL] if all logs are deleted.</p>

# [PICTURE] menu

## ● Managing the stored logs created through the [RGBCMY] mode

LOG			
ADJUSTMENT MODE	: RGBCMY		
PICTURE MODE	: NORMAL		
	COLOUR	TINT	BRIGHTNESS
RED	+10	+10	+10
GREEN	+10	+10	+10
BLUE	+10	+10	+10
CYAN	+10	+10	+10
MAGENTA	+10	+10	+10
YELLOW	+10	+10	+10
ALL DELETE			

Selected color  Adjusted color 

[RED] [GREEN] [BLUE] [CYAN] [MAGENTA] [YELLOW]	<p>Press ▲ ▼ to select the color you wish to edit, and press the &lt;ENTER&gt; button to display the screen to select [CHANGE] or [DELETE].</p> <p>[CHANGE]: You can readjust the color.</p> <p>[DELETE]: Deletes color adjustment history.</p> <p>Press the &lt;ENTER&gt; button to display a confirmation message.</p> <p>Select [OK] with the ◀▶ buttons and press the &lt;ENTER&gt; button to delete.</p>
[ALL DELETE]	<p>When [ALL DELETE] is selected using the ▲ ▼ buttons and &lt;ENTER&gt; is pressed, a confirmation message is displayed.</p> <p>Select [OK] with the ◀▶ buttons and press the &lt;ENTER&gt; button to delete all logs.</p> <p>The [PROFILE] setting will be set to [NORMAL] if all logs are deleted.</p>

### Note

- If [ADJUSTMENT MODE] is set to [RGBCMY], adjusting and registering the [COLOUR], [TINT], and [BRIGHTNESS] as [0] for adjustment values that have been previously registered deletes them from the log.

## ● Saving a log setting as a profile

Save a log setting as a profile.  
You can save up to 3 profiles.

- 1) Press the ▲ ▼ buttons to select [PROFILE SAVE] and press the <ENTER> button.
  - The [PROFILE SAVE] menu is displayed.
- 2) Press the ▲ ▼ buttons to select the number to be saved and press the <ENTER> button.

PROFILE SAVE	
★ USER1	
★ USER2	
★ USER3	

★ : When a profile is already saved  
☆ : Not saved

- The [PROFILE SAVE] confirmation message is displayed.

PROFILE SAVE	
SAVE THE PROFILE DATA AS USER 1.	
OK	CANCEL

- 3) Select [OK] with the ◀▶ buttons.
- 4) Press the <ENTER> button.
  - The [PROFILE NAME INPUT] screen is displayed.

PROFILE NAME INPUT													
A	B	C	D	E	F	G	H	I	J	K	L	M	ALL DELETE
N	O	P	Q	R	S	T	U	V	W	X	Y	Z	
a	b	c	d	e	f	g	h	i	j	k	l	m	
n	o	p	q	r	s	t	u	v	w	x	y	z	
1	2	3	4	5	6	7	8	9	0	SPACE			
!	"	#	\$	%	&	'	*	+	,	-	.	?	@
~		^	(	)	<	>	[	]	{	}	:	;	'
OK							CANCEL						

- 5) Press the ▲ ▼ ◀▶ buttons to select the characters and press the <ENTER> button for input.
  - You can enter up to 14 characters.
  - Select [ALL DELETE] and press the <ENTER> button to erase all input text. If you press the <DEFAULT> button on the remote control, you can erase the character currently selected by the cursor in the input box.
- 6) Select [OK] with the ▲ ▼ ◀▶ buttons.
- 7) Press the <ENTER> button.

### Note

- Press the <ENTER> button without entering any text to keep the default name ([USER1 - 3]).

● **Deleting a profile**

- 1) Press the ▲ ▼ buttons to select [PROFILE DELETE] and press the <ENTER> button.
  - The [PROFILE DELETE] menu is displayed.

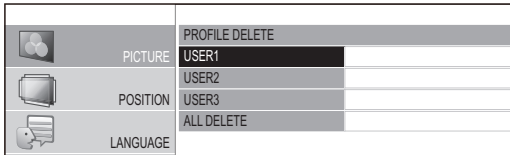

- 2) Press the ▲ ▼ buttons to select the profile to be deleted and press the <ENTER> button.
  - Select [ALL DELETE] to delete all profiles.
  - The [PROFILE DELETE] confirmation message is displayed.

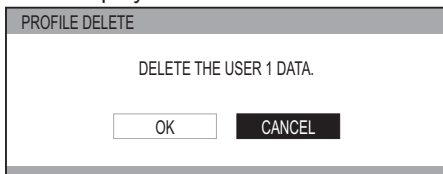

- 3) Select [OK] with the ◀ ▶ buttons.
- 4) Press the <ENTER> button.

**Note**

- If all profiles are deleted, the system returns to the [COLOUR MANAGEMENT] menu.

● **Changing a profile name**

- 1) Press the ▲ ▼ buttons to select [PROFILE NAME CHANGE] and press the <ENTER> button.
  - The [PROFILE NAME CHANGE] menu is displayed.

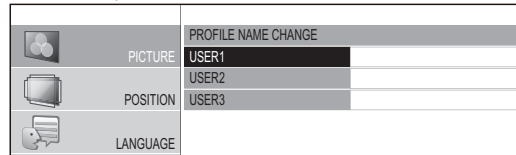

- 2) Press the ▲ ▼ buttons to select the profile name to be changed and press the <ENTER> button.
  - The [PROFILE NAME INPUT] screen is displayed.

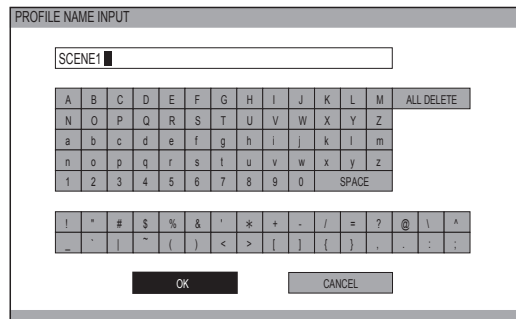

- 3) Press the ▲ ▼ ◀ ▶ buttons to specify the location of the required character and press the <ENTER> button.
  - You can enter up to 14 characters.
  - Select [ALL DELETE] and press the <ENTER> button to erase all input text. If you press the <DEFAULT> button on the remote control, you can erase the character currently selected by the cursor in the input box.
- 4) Press the ▲ ▼ ◀ ▶ buttons to select [OK].
- 5) Press the <ENTER> button.

**Note**

- Press the <ENTER> button without entering any text to keep the default name ([USER1-3]).

# [PICTURE] menu

## ● Loading saved profiles

Select a saved profile (color adjustment result). The adjustment values set in the profile are applied to the [PICTURE MODE] menu and recorded.

- 1) Press the ▲▼ buttons to select [PROFILE].
- 2) Use the ◀▶ buttons to switch the profile.

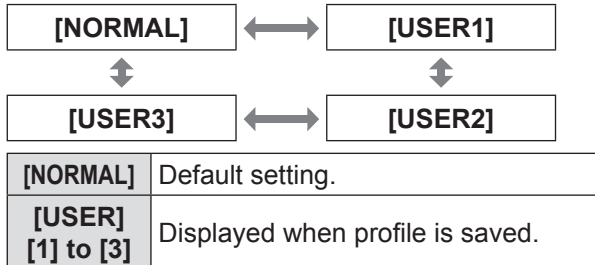

## ■ [x.v.Colour]

You can switch on/off the automatic adjustment system for signals which comply with HDMI standard (x.v.Ycc).

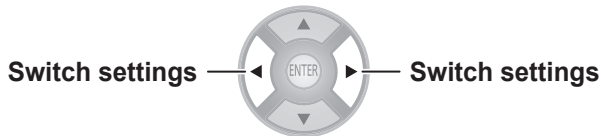

[ON]	Active
[OFF]	Inactive

### Note

- This function is only available when a signal supporting HDMI standards (x.v.Ycc) is input via an HDMI input terminal and [PICTURE MODE] is set to [REC709].

## ■ [DETAIL CLARITY]

You can adjust the detail clarity system levels.

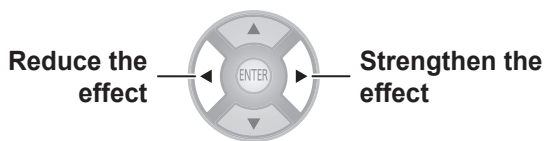

- Setting range: 0 to +7

## ■ [CINEMA REALITY]

You can switch the automatic image synchronizer on/off for 24 frames a second images, such as movies.

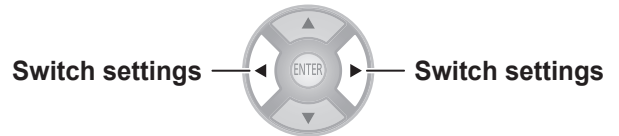

[ON]	Cinema reality active
[OFF]	Cinema reality inactive

### Note

- [CINEMA REALITY] is effective only with interlace signals.

## ■ [TV-SYSTEM]

[Only during VIDEO or S-VIDEO signal input]

The projector automatically detects the input signal but if an unstable signal is input, set the system manually. Set with a system format that matches the input signal.

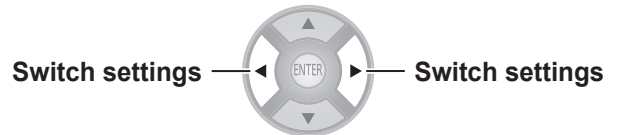

The settings change as follows each time the button is pressed.

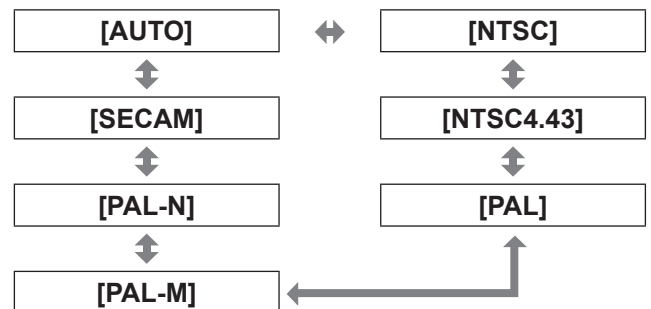

### Attention

- Set this to [AUTO] under normal conditions.
- Switch the settings to the respective TV signal formats.

### Note

- Setting [AUTO] will automatically select NTSC, NTSC4.43, PAL, PAL-M, PAL-N, SECAM, or PAL60.



■ [RGB/YC<sub>B</sub>C<sub>R</sub>], [RGB/YP<sub>B</sub>P<sub>R</sub>]

Set this to [AUTO] under normal conditions. If images are not displayed correctly when this is set to [AUTO], set either [RGB] or [YC<sub>B</sub>C<sub>R</sub>], [YP<sub>B</sub>P<sub>R</sub>] in accordance with the input signal.

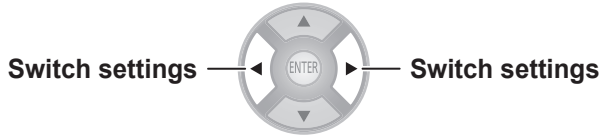

The settings change as follows each time the button is pressed.

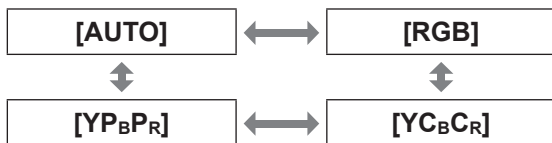

● When using COMPUTER input

- When using 480i, 480p, 576i, 576p, or VGA60 input: Select from [AUTO], [RGB], [YC<sub>B</sub>C<sub>R</sub>].
- When using a movie based signal input other than described above: Select from [AUTO], [RGB], [YP<sub>B</sub>P<sub>R</sub>].

● When using an HDMI 1/2 input

- When using a 480p or 576p input: Select from [AUTO], [RGB], [YC<sub>B</sub>C<sub>R</sub>].
- When using a movie based signal input other than described above: Select from [AUTO], [RGB], [YP<sub>B</sub>P<sub>R</sub>].

Note

- See "List of compatible signals" for signal details. (➡ page 86)
- In some cases the projector may not operate correctly with some connected devices.
- These cannot be selected using COMPONENT input terminals.

[PICTURE MEMORY]

Press the <ENTER> button.

- The [PICTURE MEMORY] menu is displayed.

PICTURE MEMORY	
PICTURE	MEMORY SAVE
POSITION	MEMORY LOAD
LANGUAGE	MEMORY DELETE
	MEMORY NAME CHANGE

■ [MEMORY SAVE]

Values set (adjustment values) for videos can be saved as favorites.

MEMORY SAVE		1/2
PICTURE	★ MEMORY1	
POSITION	★ MEMORY2	
LANGUAGE	☆ MEMORY3	
	☆ MEMORY4	
	☆ MEMORY5	

- ★ : Memory with data already stored.
- ☆ : No data stored

1) Press the ▲ ▼ buttons to select the number to be saved and press the <ENTER> button.

- The [MEMORY SAVE] confirmation message is displayed.

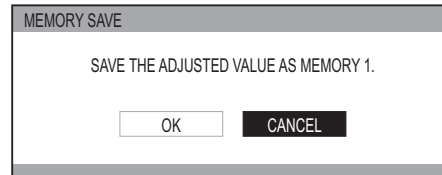

2) Select [OK] with the ◀ ▶ buttons.

3) Press the <ENTER> button.

- [MEMORY NAME INPUT] screen is displayed.

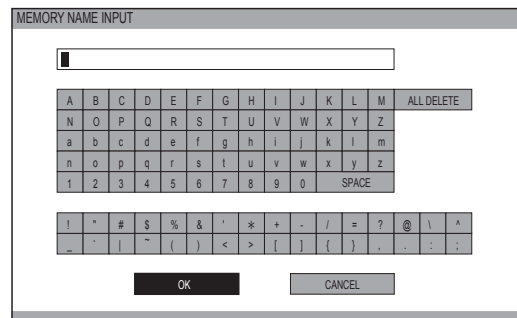

4) Press the ▲ ▼ ◀ ▶ buttons to specify the location of the required character and press the <ENTER> button.

- You can enter up to 16 characters.
- Select [ALL DELETE] and press the <ENTER> button to erase all input text. If you press the <DEFAULT> button on the remote control, you can erase the character currently selected by the cursor in the input box.

## [PICTURE] menu

5) Press the ▲▼◀▶ buttons to select [OK].

6) Press the <ENTER> button.

### Note

- Press the <ENTER> button without entering any text to keep the default name ([MEMORY1-16]).

## ■ [MEMORY LOAD]

You can access the details saved through [MEMORY SAVE].

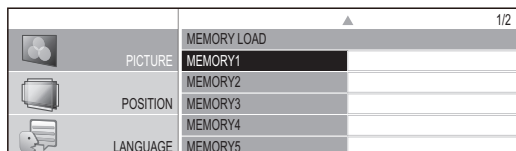

1) Press the ▲▼ buttons to select the memory name to be called.

2) Press the <ENTER> button.

- The video adjustments for the recalled memory name are switched to.

### Note

- If there is no saved setting in the [MEMORY SAVE] or [ALL DELETE] has been performed, the [MEMORY LOAD] menu will not be selectable.
- For details how to access with the remote control, see "Loading a saved setting" in "Remote control operation". (➡ page 32)

## ■ [MEMORY DELETE]

You can delete memory entries.

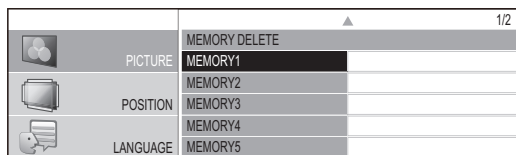

1) Press the ▲▼ buttons and select the memory name to be deleted.

2) Press the <ENTER> button.

- Select [ALL DELETE] to delete all memory entries.
- [MEMORY DELETE] confirmation message is displayed.

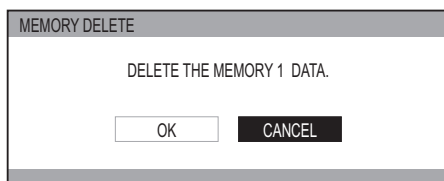

3) Select [OK] with the ◀▶ buttons.

4) Press the <ENTER> button.

## ■ [MEMORY NAME CHANGE]

You can edit the memory name settings.

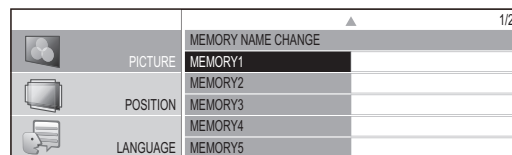

1) Press the ▲▼ buttons and select the memory name to be changed.

2) Press the <ENTER> button.

- The [MEMORY NAME INPUT] screen is displayed.

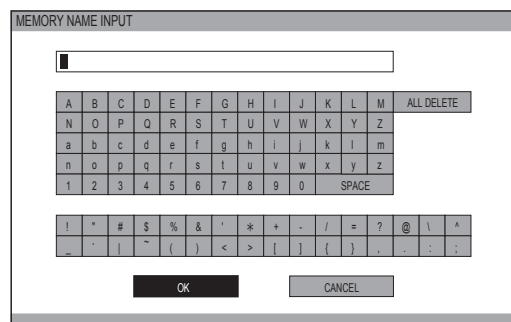

3) Press the ▲▼◀▶ buttons to specify the location of the required character to enter and press the <ENTER> button.

- You can enter up to 16 characters.
- Select [ALL DELETE] and press the <ENTER> button to erase all input text. If you press the <DEFAULT> button on the remote control, you can erase the character currently selected by the cursor in the input box.

4) Press the ▲▼◀▶ buttons to select [OK].

5) Press the <ENTER> button.

### Note

- Press the <ENTER> button without entering any text to keep the default name ([MEMORY1-16]).

## SIGNAL MODE

(Available with signals from COMPUTER IN/COMPONENT IN/HDMI IN only.)

The name of the signal being projected is displayed.

### Note

- See "List of compatible signals" for signal details. (➡ page 86)

# [POSITION] menu

Select [POSITION] from the main menu in “Navigating through the menu” (➡ page 34) and choose an item from the submenu.

- After selecting an item, use the ◀▶ to adjust the screen position.

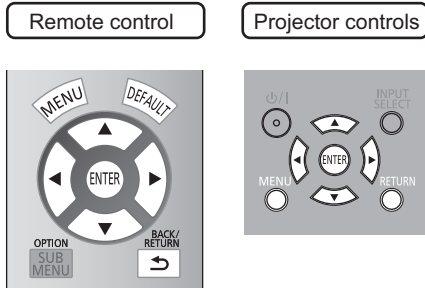

## [H-POSITION]

If the position of the picture projected on the screen deviates when the relative position of the projector and the screen is correctly set, move the picture position horizontally.

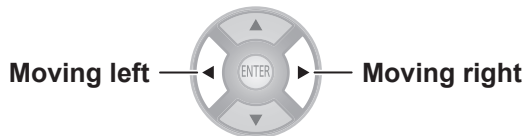

## [V-POSITION]

If the position of the picture projected on the screen deviates when the relative position of the projector and the screen is correctly set, move the picture position vertically.

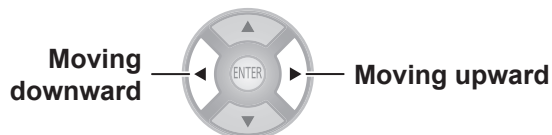

## [DOT CLOCK]

This reduces noise that occurs when projecting striped patterns.

When the kind of striped pattern shown below is projected, periodic noise sometimes occurs. In such cases, use the ◀▶ buttons to adjust to the setting with the least noise.

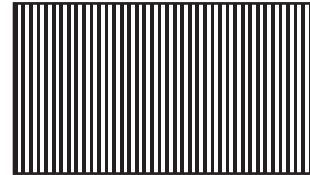

### Note

- Clock adjustment is feasible for COMPUTER (RGB) signal input other than 480i, 576i, 480p, and 576p.

### Attention

- [DOT CLOCK] needs to be adjusted before adjusting the [CLOCK PHASE].

## [CLOCK PHASE]

[Available with signals from COMPUTER IN/ COMPONENT IN only]

If flickering of the image or bleeding of contours occurs, make adjustments to ensure the optimum image display.

Use the ◀▶ buttons to adjust noise so that it is not prominent.

### Note

- If the projecting signal's dot clock frequency is higher than 154 MHz, adjusting [DOT CLOCK] or [CLOCK PHASE] may not eliminate noise.
- [CLOCK PHASE] cannot be adjusted when a 480i or 576i COMPONENT (YCbCr) signal is input.
- [CLOCK PHASE] cannot be adjusted when a 480i or 576i COMPUTER (RGB) signal is input.
- When using digital signal input, adjustment is not feasible.

# [POSITION] menu

## [ASPECT]

You can switch the image aspect ratio manually when needed.

Aspect ratio depends on signals.

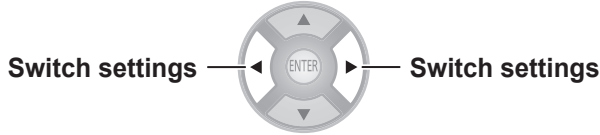

### When a VIDEO/S-VIDEO signal is input

[NTSC/NTSC4.43/PAL-M/PAL60 input]

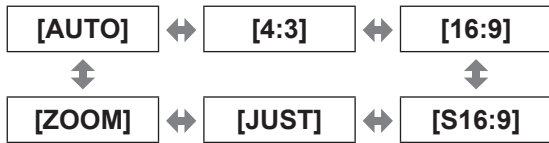

#### Note

- [AUTO] is enabled only when an NTSC signal is input for both VIDEO and S-VIDEO signals.

[PAL/PAL-N/SECAM input]



### When a COMPUTER (RGB) signal is input



#### Note

- If using a 1 280 × 720/60, 1 280 × 768/60, 1 280 × 800/60, WXGA+60, 1 920 × 1 080/50, 1 920 × 1 080/60, or WUXGA60RB signal, the aspect ratio is fixed so this cannot be switched.

### HDMI

[1 080/60i, 1 080/50i, 1 080/60p, 1 080/50p, 1 080/24p, 720/60p, 720/50p input]

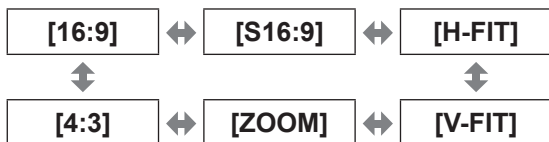

[480p input]

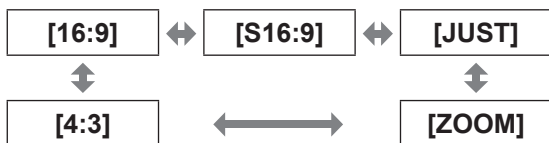

[576p input]



### COMPONENT signal (Y<sub>C</sub>B<sub>C</sub>R/Y<sub>P</sub>B<sub>P</sub>R) / COMPUTER (RGB) signal

[1 080/60i, 1 080/50i, 1 080/60p, 1 080/50p, 1 080/24p, 720/60p, 720/50p input]

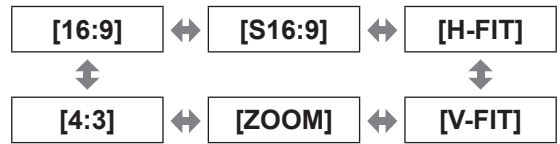

[480i/480p input]

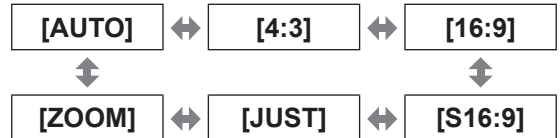

[576i/576p input]



#### Attention

- If a 4:3 aspect video is projected at a 16:9 aspect ratio, the edges may not be visible or the shape of the image may change. Please project videos intended by the author for 4:3 projection at that aspect ratio.

#### Note

- If an aspect ratio that differs from the one used in the input signal is selected, the video will look different from the original.
- If you project a copyrighted image enlarged or distorted by using [ASPECT] function in commercial use in a public place, such as a restaurant or hotel, you might infringe on the copyright of the creator which is protected by copyright law.
- When set to [AUTO], the aspect ratio is automatically switched to the optimum aspect ratio when an aspect ratio identifier is included in the input signal.
- [AUTO] may not be displayed if the input signal is VIDEO or COMPONENT (Y<sub>C</sub>B<sub>C</sub>R/Y<sub>P</sub>B<sub>P</sub>R).
- A black area may appear at the top and bottom of the screen when videos that are wider than 16:9 (cinema vision etc.) are projected.
- When a signal is input that uses overseas broadcasting formats, the supported aspect ratio modes differ from the table shown.

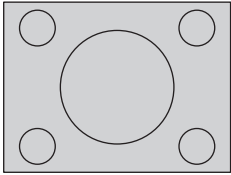
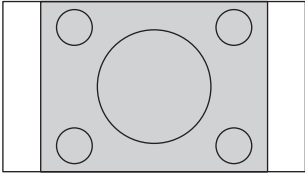
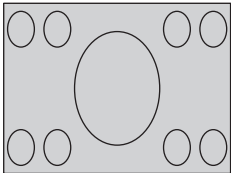
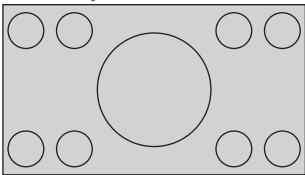
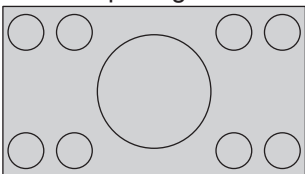
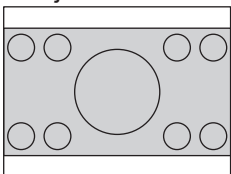
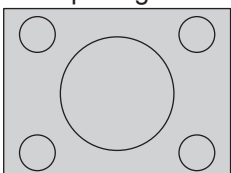
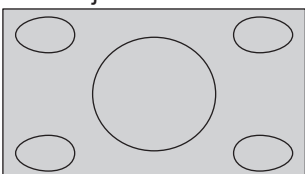
Aspect	Screen
<p><b>[4:3]</b> Projects at 4:3.</p>	<p>Input signal</p>  <p>↓</p> <p>Projection screen</p> 
<p><b>[16:9]</b> Projects at 16:9. (Enlarged horizontally)</p>	<p>Input signal</p>  <p>↓</p> <p>Projection screen</p> 
<p><b>[S16:9]</b> Projects a 16:9 aspect video onto a 4:3 aspect screen.</p>	<p>Input signal</p>  <p>↓</p> <p>Projection screen</p> 
<p><b>[JUST]</b> Adjusts horizontally to fit 16:9. When projecting a 4:3 aspect ratio video, distortion in the center of the screen is reduced. (Enlarged horizontally)</p>	<p>Input signal</p>  <p>↓</p> <p>Projection screen</p> 

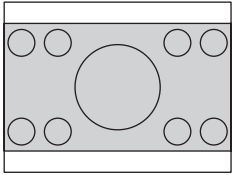
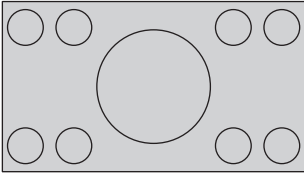
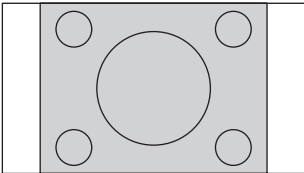
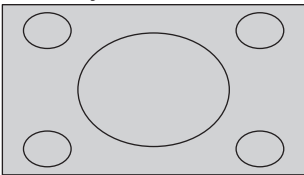
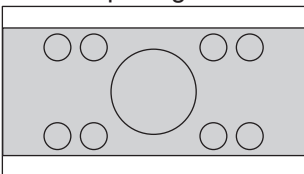
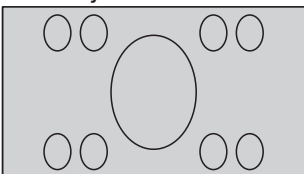
Aspect	Screen
<p><b>[ZOOM]</b> Enlarges while preserving original ratio. The projected video may be clipped in some cases, but the video can be accurately reproduced. Use the ▲ ▼ buttons to adjust vertically. (Not available with HDMI signal.)</p>	<p>Input signal</p>  <p>↓</p> <p>Projection screen</p> 
<p><b>[H-FIT]</b> Adjusts horizontally to fit 16:9. (Enlarged horizontally)</p>	<p>Input signal</p>  <p>↓</p> <p>Projection screen</p> 
<p><b>[V-FIT]</b> Adjusts vertically to fit 16:9. (Enlarged vertically) Use the ▲ ▼ buttons to adjust vertically. (Not available with HDMI signal.)</p>	<p>Input signal</p>  <p>↓</p> <p>Projection screen</p> 

## [POSITION] menu

### [WSS]

In the European broadcasting system, if the input signal contains an identification signal, WSS automatically switches the aspect ratio to the required setting. (➔ page 56)

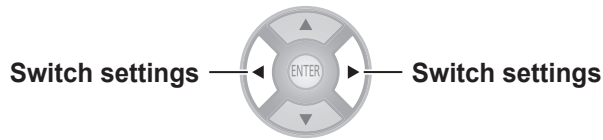

[ON]	Switch automatically
[OFF]	Do not switch automatically

#### Note

- Aspect ratio switches only in the case of these input signals: PAL/625i (576i)/625p (576p)

### [OVER SCAN]

If the 4 edges of an image are partly dropped, you can use this function to adjust and project it properly.

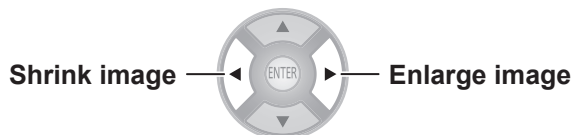

- Setting range: 0 to +10

#### Note

- COMPUTER signal (exc. movie based signals) is not supported.

### [KEystone]

If the projector is aligned non-perpendicularly to the screen, or if the projection screen has an angled surface, you can correct the keystone vertically.

Image	Operation

- Setting range: -32 to +32

#### Note

- You can correct the distortion  $\pm 30$  degrees from the vertical plane. However, if there is overcorrection, the image quality may deteriorate and become blurry. For a better quality image, installing the projector with minimum distortion is recommended.
- The result of the keystone correction will affect the size of the image.
- Keystone correction does not function on the menu screen.
- When adjustment with [KEystone] carried out, the vertical center of the screen and the lens need to be realigned.
- Some distortion may occur due to lens shift adjustment.
- The result of the keystone correction may affect the aspect ratio.

### [AUTO SETUP]

(COMPUTER IN only)

When you select [AUTO SETUP] and then press the <ENTER> button, [H-POSITION], [V-POSITION], [DOT CLOCK], and [CLOCK PHASE] are adjusted automatically in accordance with the input signal.

## [SCREEN AREA MEMORY]

Press the <ENTER> button to display the [SCREEN AREA MEMORY] menu.

SCREEN AREA MEMORY		
PICTURE	MEMORY LOAD	
	MEMORY SAVE	
POSITION	MEMORY EDIT	
	AUTO SWITCHING	
LANGUAGE	H-AREA POSITION	
	V-AREA POSITION	
OPTION	LEFT MASKING AREA	
	RIGHT MASKING AREA	
	UPPER MASKING AREA	
	LOWER MASKING AREA	
	ASPECT	16:9

### [MEMORY LOAD]

- You can recall horizontal and vertical video positions, mask amount adjustment values, and aspect settings saved with [MEMORY SAVE] (➔ page 59).

SCREEN AREA MEMORY LOAD	
PICTURE	MEMORY1
	MEMORY2
POSITION	MEMORY3
	MEMORY4
LANGUAGE	MEMORY5
OPTION	MEMORY6

- Press the ▲ ▼ buttons to select the memory name to be recalled.
- Press the <ENTER> button.
  - The video adjustments for the recalled memory are switched to.

#### Note

- If a setting is not saved using [MEMORY SAVE] or all memories are deleted using [MEMORY DELETE] in the [SCREEN AREA MEMORY] menu, the [MEMORY LOAD] menu will not be displayed.

### [MEMORY SAVE]

This enables saving horizontal video position, vertical video position, adjustment for amount of mask, and aspect settings.

SCREEN AREA MEMORY SAVE	
PICTURE	☆ MEMORY1
	★ MEMORY2
POSITION	☆ MEMORY3
	☆ MEMORY4
LANGUAGE	☆ MEMORY5
OPTION	☆ MEMORY6

★ : Memory with data already stored.

☆ : No data stored

- Press the ▲ ▼ buttons to select the memory to be saved.
- Press the <ENTER> button.
  - The [SCREEN AREA MEMORY SAVE] confirmation message is displayed.

SCREEN AREA MEMORY SAVE	
SAVE THE ADJUSTED VALUE AS MEMORY 1.	
OK	CANCEL

- Select [OK] with the ◀ ▶ buttons.
- Press the <ENTER> button.
  - [SCREEN AREA MEMORY NAME INPUT] screen is displayed.

SCREEN AREA MEMORY NAME INPUT	
[Input Field]	
A B C D E F G H I J K L M	ALL DELETE
N O P Q R S T U V W X Y Z	
a b c d e f g h i j k l m	
n o p q r s t u v w x y z	
1 2 3 4 5 6 7 8 9 0	SPACE
! " # \$ % & ' * + , - . / = ? @ [ \ ] ^ _	
~ `   ~ ( ) < > [ ] { } . : ;	
OK	CANCEL

- Press the ▲ ▼ ◀ ▶ buttons to specify the location of the required character and press the <ENTER> button.
  - You can enter up to 16 characters.
  - Select [ALL DELETE] and press the <ENTER> button to erase all input text. If you press the <DEFAULT> button on the remote control, you can erase the character currently selected by the cursor in the input box.
- Press the ▲ ▼ ◀ ▶ buttons to select [OK].
- Press the <ENTER> button.

#### Note

- Press the <ENTER> button without entering any text to keep the default name ([MEMORY1-6]).



# [POSITION] menu

## ■ [MEMORY EDIT]

You can delete memory entries and edit the memory name settings.

PICTURE	SCREEN AREA MEMORY EDIT
POSITION	MEMORY DELETE
LANGUAGE	MEMORY NAME CHANGE
OPTION	

### ● [MEMORY DELETE]

- 1) Press the ▲ ▼ buttons and select the memory name to be deleted.

PICTURE	SCREEN AREA MEMORY DELETE
POSITION	MEMORY1
LANGUAGE	MEMORY2
OPTION	MEMORY3
	MEMORY4
	MEMORY5
	MEMORY6
	ALL DELETE

- Select [ALL DELETE] to delete all memory entries.

- 2) Press the <ENTER> button.
  - The [SCREEN AREA MEMORY DELETE] confirmation message is displayed.

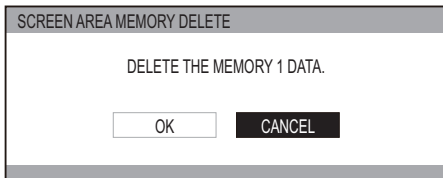

- 3) Select [OK] with the ◀ ▶ buttons.
- 4) Press the <ENTER> button.

### ● [MEMORY NAME CHANGE]

- 1) Press the ▲ ▼ buttons to select the memory name to be changed.

PICTURE	SCREEN AREA MEMORY NAME CHANGE
POSITION	SCREEN 1
LANGUAGE	MEMORY2
OPTION	MEMORY3
	MEMORY4
	MEMORY5
	MEMORY6

- 2) Press the <ENTER> button.
  - [SCREEN AREA MEMORY NAME INPUT] screen is displayed.

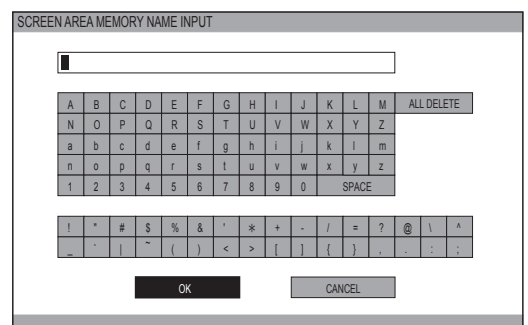

- 3) Press the ▲ ▼ ◀ ▶ buttons to specify the location of the required character and press the <ENTER> button.
  - You can enter up to 16 characters.
  - Select [ALL DELETE] and press the <ENTER> button to erase all input text. If you press the <DEFAULT> button on the remote control, you can erase the character currently selected by the cursor in the input box.

- 4) Press the ▲ ▼ ◀ ▶ buttons to select [OK].
- 5) Press the <ENTER> button.

#### Note

- Press the <ENTER> button without entering any text to keep the default name ([MEMORY1-6]).



## [AUTO SWITCHING]

This function automatically identifies wide signal\*1 or 16:9/4:3 and automatically recalls memory settings that have been set for each screen size.

\*1 : Wide signals are 2.35:1, 2.40:1, 2.50:1, 2.55:1 aspect signals.

		SCREEN AREA MEMORY AUTO SWITCHING
PICTURE	2.35:1 IMAGE DETECTION	OFF
POSITION	16:9 IMAGE DETECTION	OFF
LANGUAGE		
OPTION		

1) Use the ▲ ▼ buttons to select the item for automatic identification.

2) Press the ◀ ▶ buttons to select the required memory for automatic identification.

- The memory setting which has been selected for [2.35:1 IMAGE DETECTION] is loaded after a given period of time once the input signal switches from 16:9/4:3 to 2.35:1.
- The memory setting which has been selected for [16:9 IMAGE DETECTION] is loaded after a given period of time once the input signal switches from 2.35:1 to 16:9/4:3.
- If [OFF] is selected, automatic identification will not be performed.
- This function is not available when [ZOOM] or [V-FIT] is selected from the [ASPECT] menu.

### Note

- If the memory is not registered using [MEMORY SAVE] in the [SCREEN AREA MEMORY] menu, you cannot select [AUTO SWITCHING].
- When displaying the menu or test pattern, automatic identification is not performed.
- Images may not be correctly recognized if there is noise in the picture or external device generates noise. Image size may also not be correctly recognized depending on the video.
- Image size may not be correctly recognized if the input signal level from the external device is not set to the suggested value range. In this case, adjust the input signal level using the [WAVEFORM MONITOR] menu. (▶ page 39)
- Image size may not be correctly recognized if the screen position is not correctly adjusted. In this case, adjust the screen position using the [POSITION] menu. (▶ page 55)

## [H-AREA POSITION]

You can move the frame area horizontally, such as aligning the right or left frame edge to the screen edge.

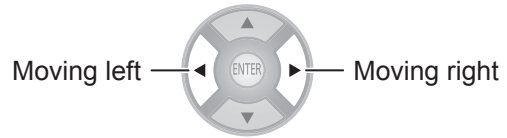

For example, when projecting an overscanned 16:9 projection area at a 4:3 aspect ratio on a 4:3 aspect screen, you can adjust the horizontal discrepancy between the screen position and the video display position.

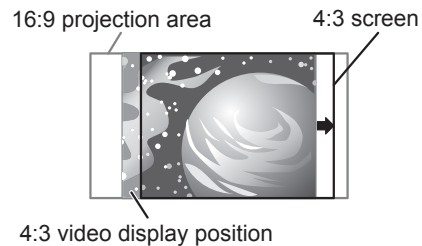

## [V-AREA POSITION]

You can move the frame area vertically, such as aligning the top or bottom frame edge to the screen edge.

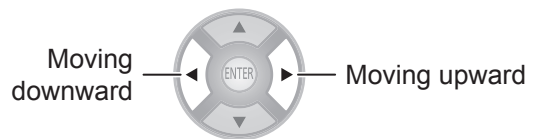

For example, when projecting an overscanned 16:9 projection area at a 2.35:1 cinema scope screen size on a 2.35:1 size cinema scope screen, you can adjust the vertical discrepancy between the screen position and the video display position.

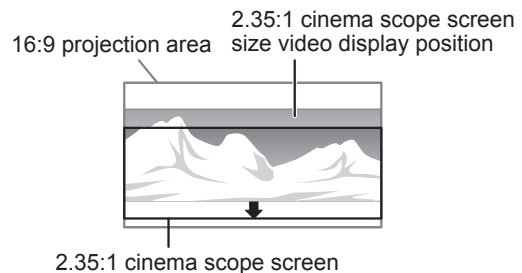

## [POSITION] menu

### ■ [LEFT MASKING AREA]

You can place a blank (mask) area in the left side edge on the screen.

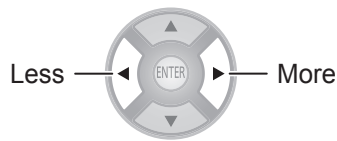

- Setting range: 0 to 70

### ■ [RIGHT MASKING AREA]

You can place a blank (mask) area in the right side edge on the screen.

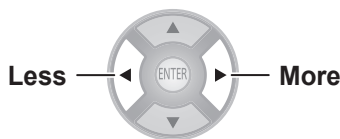

- Setting range: 0 to 70

### ■ [UPPER MASKING AREA]

You can place a blank (mask) area in the upper side edge on the screen.

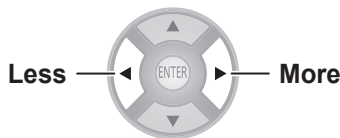

- Setting range: 0 to 70

### ■ [LOWER MASKING AREA]

You can place a blank (mask) area in the lower side edge on the screen.

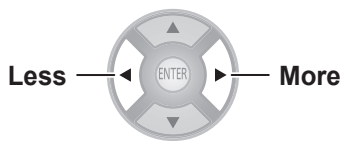

- Setting range: 0 to 70

#### Note

- If it is set to [0], each masking function will be invalid.
- The [MASKING AREA] function will be invalid when adjusting the [COLOUR MANAGEMENT] or [SPLIT ADJUST] settings, when displaying the [TEST PATTERN] or [WAVEFORM MONITOR], or when no signal is detected.

### ■ ASPECT

The aspect ratio for the current video is displayed.

#### Note

- See "[ASPECT]" for ASPECT details. (➡ page 56)

# [OPTION] menu

Select [OPTION] from the main menu of "Navigating through the menu" (➡ page 34), and choose an item from the submenu.

- Select item and use the ◀ ▶ buttons to switch the settings.

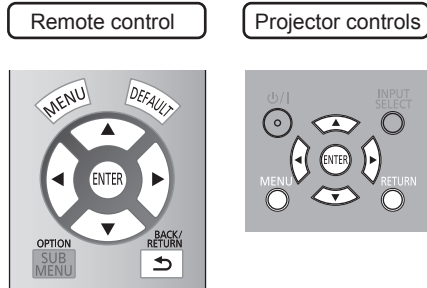

## [ON-SCREEN DISPLAY]

This enables setup related to on-screen display.

Press the <ENTER> button.

- The [ON-SCREEN DISPLAY] menu is displayed.

	ON-SCREEN DISPLAY	
PICTURE	INPUT GUIDE	DETAILED
POSITION	OSD DESIGN	TYPE1
	OSD POSITION	CENTRE
LANGUAGE		
OPTION		

### [INPUT GUIDE]

Set the display method for the currently selected input port name. This is displayed in the top right of the screen when the <INPUT SELECT> button is pressed. (➡ page 33)

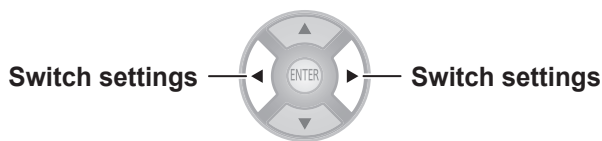

[DETAILED]	Display the input terminal graphically
[OFF]	Turn off the guidance
[SIMPLE]	Display the name of input terminal only

### [OSD DESIGN]

Set the color of the on-screen menu.

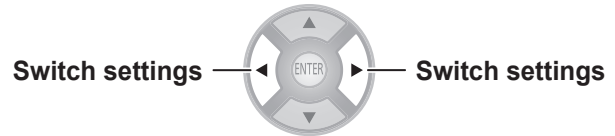

[TYPE1]	Display using normal design
[TYPE2]	Display using black and white design

### [OSD POSITION]

You can change the displaying position of the on-screen menu.

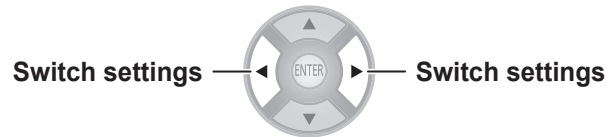

[CENTRE]	Display in the center of the projection screen
[LOWER LEFT]	Display in the bottom left of the projection screen
[LOWER CENTRE]	Display in the bottom center of the projection screen
[LOWER RIGHT]	Display in the bottom right of the projection screen
[UPPER LEFT]	Display in the upper left of the projection screen
[UPPER CENTRE]	Display in the upper center of the projection screen
[UPPER RIGHT]	Display in the upper right of the projection screen

## [BACK COLOUR]

Set the color of the projection screen when no signal is input.



[BLUE]	Display the whole projection screen blue
[BLACK]	Display the whole projection screen black

## [OPTION] menu

### [STARTUP LOGO]

You can switch the Panasonic logo that is displayed when starting up the projector on/off.

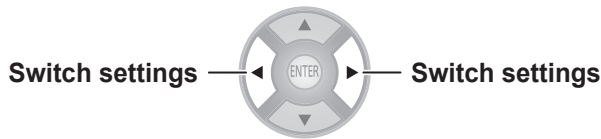

[ON]	Active
[OFF]	Inactive

#### Note

- The logo Panasonic is displayed for 15 seconds.

### [AUTO SEARCH]

Sets whether to automatically search for terminals that have an input signal when the projector is turned on.

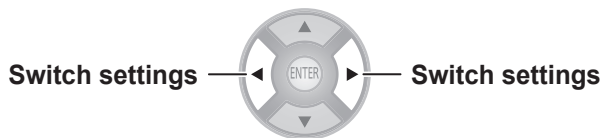

[ON]	Active
[OFF]	Inactive

#### Attention

- Set this to [ON] under normal circumstances.
- When no signal is detected, the last used input will be selected.

### [HDMI SIGNAL LEVEL]

If video is not displayed correctly when this projector is connected to an external device via an HDMI connection, switch the settings.

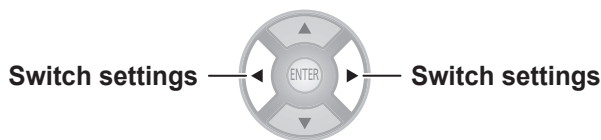

[NORMAL]	Signal level used by general external devices
[EXPAND]	Expanded signal level used by some devices

#### Note

- This may not work correctly with some external devices, and problems such as video not being displayed may occur.

### [FRAME RESPONSE]

Switch this setting when a progressive signal is input and you wish to reduce the time taken from the signal being input to the video being displayed on the screen.

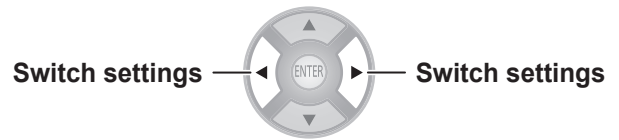

[NORMAL]	Prioritizes the image quality
[FAST]	Prioritizes the frame response

#### Note

- [NORMAL] allows higher quality image viewing.

### [PROJECTION METHOD]

Set the projection method according to the projector installation status. Change the projection method if the screen is displayed upside down or the display is reversed. (➡ page 20)

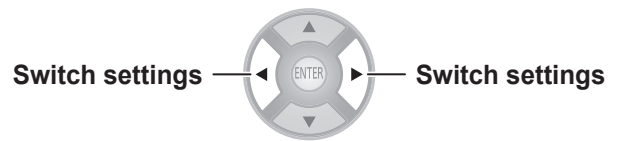

[FRONT/DESK]	When setting on a desk/floor and projecting from the front
[FRONT/CEILING]	When using the ceiling mount bracket (optional accessory) and projecting from the front
[REAR/DESK]	When setting on a desk/floor and projecting from the rear (using a translucent screen)
[REAR/CEILING]	When using the ceiling mount bracket (optional accessory) and projecting from the rear (using a translucent screen)

[TRIGGER 1/2 SETTING]

You can set the function for each trigger terminal.

Attention

- Make sure the <MAIN POWER> switch of the projector is turned <OFF> before a cable is connected to or disconnected from a trigger terminal.

[OUTPUT]

In conjunction with projector operation set in the [TRIGGER 1 SETTING]/[TRIGGER 2 SETTING] menu, a trigger output signal is sent to an external device with a trigger terminal to enable control.

[INPUT]

Receipt of a trigger input signal from an external device enables control of projector operation setup in the [TRIGGER 1 SETTING]/[TRIGGER 2 SETTING] menu.

		ON-SCREEN DISPLAY	▲	1/2
PICTURE		BACK COLOUR	BLUE	
		STARTUP LOGO	ON	
		AUTO SEARCH	ON	
POSITION		HDMI SIGNAL LEVEL	NORMAL	
		FRAME RESPONSE	NORMAL	
LANGUAGE		PROJECTION METHOD	FRONT/DESK	
		TRIGGER 1 SETTING	OFF	
OPTION		TRIGGER 2 SETTING	OFF	
		HIGH ALTITUDE MODE	OFF	
		LAMP POWER	NORMAL	
		ECO MANAGEMENT		
		FUNCTION BUTTON		
		VIERA LINK SETTINGS		

- 1) Use the ▲ ▼ buttons to select [TRIGGER 1 SETTING] or [TRIGGER 2 SETTING] and press the <ENTER> button.

- The [TRIGGER SETTING] menu is displayed.

		TRIGGER 1 SETTING	
PICTURE		● OFF	
		OUTPUT	
POSITION		POWER ON	SELECT 4:3 ASPECT
		SCREEN AREA MEMORY 1	SELECT 16:9 ASPECT
LANGUAGE		SCREEN AREA MEMORY 2	SELECT S16:9 ASPECT
		SCREEN AREA MEMORY 3	SELECT JUST ASPECT
OPTION		SCREEN AREA MEMORY 4	SELECT ZOOM ASPECT
		SCREEN AREA MEMORY 5	SELECT H-FIT ASPECT
		SCREEN AREA MEMORY 6	SELECT V-FIT ASPECT
		BLANK	RS-232C COMMAND LINK
	DELAY TIME	0 SEC.	
	INPUT		
	POWER ON/OFF	BLANK	

- 2) Press the ▲ ▼ ◀ ▶ buttons to select the input/output function and press the <ENTER> button.

- Function settings

[OFF]	Unable to transmit the trigger output signal. Does not function even if trigger input signal is received. (Trigger input signal can be received.)
-------	---

- Output

[POWER ON]	[SELECT 4:3 ASPECT]
[SCREEN AREA MEMORY 1]	[SELECT 16:9 ASPECT]
[SCREEN AREA MEMORY 2]	[SELECT S16:9 ASPECT]
[SCREEN AREA MEMORY 3]	[SELECT JUST ASPECT]
[SCREEN AREA MEMORY 4]	[SELECT ZOOM ASPECT]
[SCREEN AREA MEMORY 5]	[SELECT H-FIT ASPECT]
[SCREEN AREA MEMORY 6]	[SELECT V-FIT ASPECT]
[BLANK]	[RS-232C COMMAND LINK]

When the item which is set in the [TRIGGER 1 SETTING]/[TRIGGER 2 SETTING] menu is chosen or executed in the projector, 12 V is output from a trigger terminal.

Note

- When [AUTO] is selected in the [ASPECT] menu of [POSITION], video is automatically displayed using either 4:3 or 16:9 aspect ratio depending on the input signal, so if this aspect ratio matches the settings made in [TRIGGER 1 SETTINGS] or [TRIGGER 2 SETTINGS] 12 V is output.
- [BLANK]  
When [BLANK] is activated, output is 12 V. If the setting is released, output is 0 V.
- [RS-232C COMMAND LINK]  
Receives commands (▶ page 88) from external device and outputs 12 V.

## [OPTION] menu

### ● Input

[POWER ON/OFF]	[BLANK]
----------------	---------

#### ● [POWER ON/OFF]

If the trigger input signal from the external device is changed from 0 V to 12 V, the projector power will be switched on. And if it is changed from 12 V to 0 V, the power will be switched off.

#### ● [BLANK]

If the trigger input signal from the external device is changed from 0 V to 12 V, the screen will go blank. And if it is changed from 12 V to 0 V, the [BLANK] setting will be released.

### 3) Press the ▲▼◀▶ buttons to move the cursor to [DELAY TIME]

### 4) Press the ◀▶ buttons to set the delay time for the trigger output signal

- The delay time can be set to 2, 4, 6, 8, 10, 20, and 30 seconds.
- It is possible to delay the trigger output signal (12 V) by the amount of time set. (Only available if trigger output item is selected.)

E.g.) Select [SELECT 4:3 ASPECT] of the trigger output function and set the delay time to 10 seconds.

- ➔ Set the [ASPECT] in the [POSITION] menu to [4:3], and 12V is output from the trigger port after 10 seconds.

### Note

- You should not use trigger terminal output as the power source for other devices.
- The projector will not accept trigger input while preparing to project after the power has been switched on and while preparing to shutdown after projection. Input trigger signals after projection starts or after entering standby mode.
- 12 V cannot be output from the trigger terminal when the projector is in standby mode.

## [HIGH ALTITUDE MODE]

Set to [ON] when using at locations between 1400 m and 2 700 m above sea level.

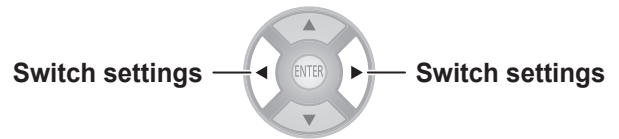

[OFF]	When using at an altitude of less than 1 400 m above sea level
[ON]	When using at high altitudes (between 1 400 m and 2 700 m above sea level)

### Note

- The fan rotation and operating noise increases if set to [ON].

## [LAMP POWER]

Switch the lamp intensity according to the usage environment of the projector and its intended use.

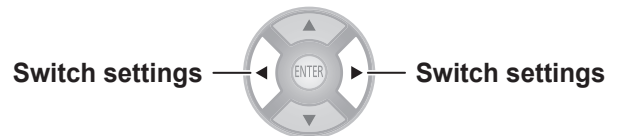

[NORMAL]	When higher luminance is required
[ECO]	When lower luminance is sufficient

### Note

- The brightness in the [ECO] settings is lowered enabling saving power and reducing operating noise. It is recommended that you use the [ECO] setting when viewing in a place where natural light is blocked and there is no artificial light.
- When no input signal is detected, the function is disabled.

## [ECO MANAGEMENT]

You can reduce power consumption by optimizing the lamp power in accordance with the usage state.

Press the <ENTER> button.

- The [ECO MANAGEMENT] menu is displayed.

		ECO MANAGEMENT	
PICTURE	AUTO POWER SAVE	ON	
	AMBIENT LIGHT DETECTION	ON	
POSITION	SIGNAL DETECTION	ON	
	BLANK DETECTION	ON	
LANGUAGE	SLEEP	OFF	
OPTION			

### Note

- [LAMP POWER] may not automatically decrease in the following cases.
  - When [LAMP POWER] is set to [ECO].
  - Immediately after the lamp illuminates or after [LAMP POWER] is set.
- When [AUTO POWER SAVE] is [OFF], [AMBIENT LIGHT DETECTION], [SIGNAL DETECTION], and [BLANK DETECTION] cannot be set.

## [AUTO POWER SAVE]

Sets whether the functions [AMBIENT LIGHT DETECTION], [SIGNAL DETECTION], and [BLANK DETECTION] are active.

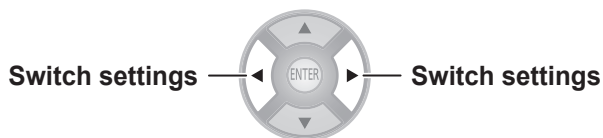

[ON]	Energy saving settings active
[OFF]	Energy saving settings inactive

### Note

- Settings cannot be made when [LAMP POWER] is set to [ECO].

## [AMBIENT LIGHT DETECTION]

You can adjust the lamp power in accordance with brightness of the installation location.

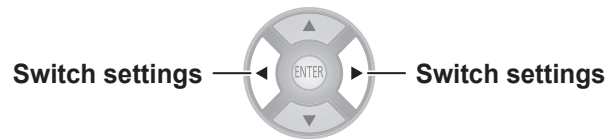

[ON]	Adjust lamp power
[OFF]	Do not adjust lamp power

## [SIGNAL DETECTION]

You can reduce the lamp power when no signal is input.

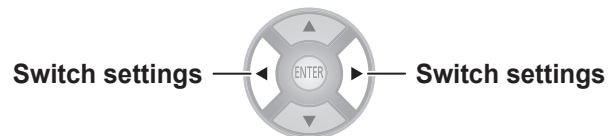

[ON]	Adjust lamp power
[OFF]	Do not adjust lamp power

## [BLANK DETECTION]

You can reduce the lamp power when the signal is blank.



[ON]	Adjust lamp power
[OFF]	Do not adjust lamp power



## [OPTION] menu

### ■ [SLEEP]

Set the time for the power to be automatically turned off.

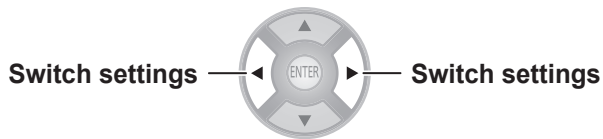

[OFF]	Inactive
[60MIN.]	Turn power off after 60 minutes
[90MIN.]	Turn power off after 90 minutes
[120MIN.]	Turn power off after 120 minutes
[150MIN.]	Turn power off after 150 minutes
[180MIN.]	Turn power off after 180 minutes
[210MIN.]	Turn power off after 210 minutes
[240MIN.]	Turn power off after 240 minutes

#### Note

- The projector automatically enters power off preparation mode (the power indicator illuminates orange), and then enters standby mode (the power indicator illuminates or flashes in red). (➡ page 27)
- 3 minutes before turn-off, the number of minutes remaining will be displayed in the lower right corner.
- If [SLEEP] mode is set to [OFF] mode before the specified time has elapsed the settings are erased.

## [FUNCTION BUTTON]

Display the function currently assigned to the <FUNCTION> button of the remote control. Also, cancel the assigned function.

### ■ How to cancel function assignment

- 1) Press the <ENTER> button.
  - The [FUNCTION BUTTON] confirmation message is displayed.

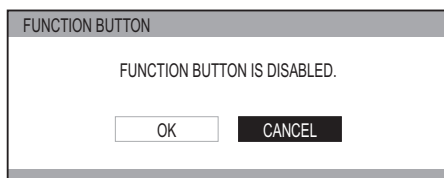

- 2) Select [OK] with the ◀ ▶ buttons.
- 3) Press the <ENTER> button.

#### Note

- See “Using the <FUNCTION> button” in “Remote control operation” regarding allocating operations to the <FUNCTION> button. (➡ page 33)

## [VIERA LINK SETTINGS]

Configure VIERA Link.

Press the <ENTER> button.

- The [VIERA LINK SETTINGS] confirmation message is displayed.

PICTURE		VIERA LINK SETTINGS	
VIERA LINK		ON	
POSITION		POWER ON LINK	OFF
LANGUAGE		POWER OFF LINK	OFF
OPTION		STANDBY POWER SAVE	OFF
		INTELLIGENT AUTO STANDBY	OFF
		VERSION : HDAVI Control 5	

### ■ [VIERA LINK]

Set whether the VIERA Link control is active.



[ON]	Active
[OFF]	Inactive

When [VIERA LINK] is [ON], the following settings can be made.

[POWER ON LINK]
[POWER OFF LINK]
[STANDBY POWER SAVE]
[INTELLIGENT AUTO STANDBY]



## ■ [POWER ON LINK]

Specify whether or not to switch the power of the projector on when it is in standby by operating external devices.

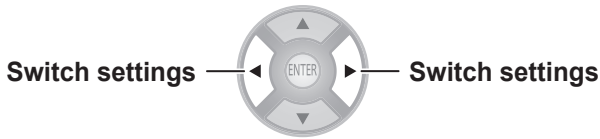

[OFF]	Inactive
[ON]	Switch projector power on along with external devices

### Note

- Depending on the external device, the projector may automatically turn on when some functions of the connected devices are used. (Only in standby)
- Due to the projector's characteristics, it takes time before projection begins. Please be aware that video may already have started by the time the projector is operating fully.

## ■ [POWER OFF LINK]

Specify whether to switch the power off for external devices when this projector is set to standby.

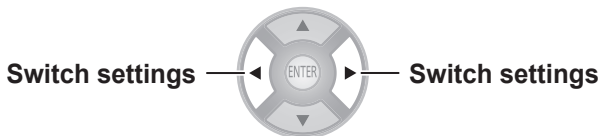

[ON]	Switch the power of external devices off along with this projector
[OFF]	Do not switch the power of external devices off along with this projector

### Note

- This function works even if the projector enters standby mode automatically through the [SLEEP] function.
- There are cases where some external devices may not be switched off depending on their status (currently recording etc.)

## ■ [STANDBY POWER SAVE]

Specify whether or not to switch the mode of external devices to the mode with minimum power consumption when the projector is set to standby.

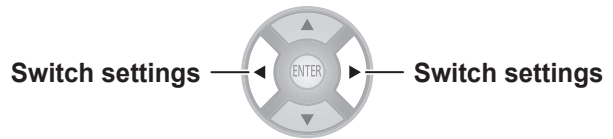

[OFF]	Do not switch
[ON]	Switch the mode of external devices to the mode with minimum power consumption

### Note

- This function works when [POWER OFF LINK] is set to [ON].
- Depending on the external devices, when the projector is turned on power consumption may increase even in [STANDBY POWER SAVE] mode in order to achieve faster start up.

## ■ [INTELLIGENT AUTO STANDBY]

Specify whether or not to keep the power on for external devices selected for input and switch the power off for external devices not selected for input.

If you select [ON (WITH REMINDER)], a message is displayed before the function operates.

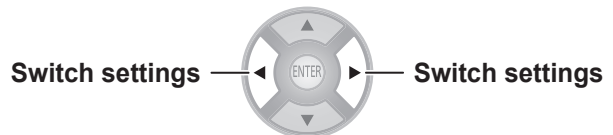

[OFF]	Maintain the power on state of devices for which input is not selected
[ON (WITH REMINDER)]	After a confirmation message is displayed, devices for which the input is not selected are set to standby mode
[ON (NO REMINDER)]	Devices for which the input is not selected are set to standby mode

### Note





- This function may not work properly depending on the external device.

## [OPTION] menu

### [OTHER FUNCTIONS]

Press the <ENTER> button.

- The [OTHER FUNCTIONS] menu is displayed.

	PICTURE	OTHER FUNCTIONS
	POSITION	FREEZE
	LANGUAGE	BLANK
	OPTION	VIERA LINK MENU

#### ■ [FREEZE]

You can temporarily freeze the projected video independently of external device playback.

Press the <ENTER> button.

- Pressing the <RETURN> button cancels the function.

#### Note

- While displaying the frozen image, you can enter the [AREA SELECT] mode of the [SPLIT ADJUST] menu by pressing the <ENTER> button. For details see [SPLIT ADJUST] in the [PICTURE] menu. (➡ page 41)

#### ■ [BLANK]

When the projector is not being used for a brief period, such as during a break in a meeting or during preparation for a meeting, the video can be stopped temporarily.

Press the <ENTER> button.

- Press any button to escape from the blank mode.

#### ■ [VIERA LINK MENU]

You can operate an HDMI-connected device.

Press the <ENTER> button.

- The [VIERA LINK MENU] menu is displayed.

[VIERA LINK CONTROL]	Selects the device to operate and switches input
[HOME CINEMA VOLUME]	Adjusts the cinema volume
[HOME CINEMA MUTE]	Mutes the cinema
[OPERATE OTHER DEVICE]	Operates third-party device

- For details, see “Using VIERA Link”. (➡ page 82)

### [TEST PATTERN]

You can display 5 types of image patterns for confirmation.

Press the <ENTER> button to switch to the other patterns. Pressing the <RETURN> button cancels the function.

### [LAMP RUNTIME]

You can check how long the lamp has been used.

#### Attention

- When replacing the lamp, follow the “Lamp unit replacement procedure” (➡ page 77) and set the runtime to [0].

#### Note

- When the lamp unit has reached the end of its lifespan the [LAMP RUNTIME] menu will provide the usage time notification by flashing red and gray. See “When to replace the lamp unit” (➡ page 76) about the lifespan.

# TEMP and LAMP Indicators

## Managing the indicated problems

If a problem should occur with the projector, the lamp indicator <LAMP> and/or temperature indicator <TEMP> will illuminate or flash. Check the indicator status and deal with problems as follows.

### Attention

- When switching off power to deal with problems, ensure that you follow the procedure in “Switching off the power”. (➡ page 29)

### Note

- Check the status of the power supply with the power indicator <ON (G)/STANDBY (R)>. (➡ page 27)

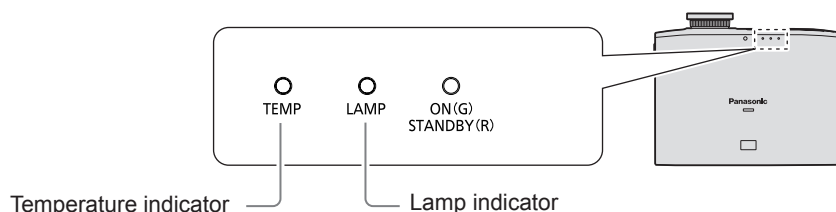

## Temperature indicator <TEMP>

<b>Indicator status</b>	<ul style="list-style-type: none"> <li>● Illuminates red during projection. (Alert indicating [REFER TO THE “TEMP indicator” SECTION IN THE OPERATION MANUAL.] is displayed.)</li> <li>● Flashing red when power is turned off (projection stops automatically).</li> </ul>			
<b>Problem</b>	The temperature inside and/or outside the projector is abnormally high.			
<b>Cause</b>	The air intake and exhaust ports may be obstructed.	The room temperature may be too high.	The air filter unit may be excessively dirty and ventilation may be poor.	The projector may be being used at high elevations (1 400 m or more above sea level).
<b>Solution</b>	Remove object(s) from the ventilation ports or clear the area around the projector.	Place the projector in an environment with temperature and humidity as designated in the specifications. (➡ page 90)	Clean or replace the air filter unit. (➡ page 73)	The projector can only be used for two minutes after turning on. Set [HIGH ALTITUDE MODE] to [ON] within two minutes of turning the projector on. (➡ page 66)

### Note

- If the <TEMP> indicator is illuminated or flashes despite taking the actions above, please contact your dealer to have your projector repaired.

# TEMP and LAMP Indicators

## ■ Lamp indicator <LAMP>

Indicator status	Illuminated red	Flashing red	
<b>Problem</b>	Time to replace the lamp unit. Illuminates when the lamp unit has reached its maximum usage period of 1 800 hours (when [LAMP POWER] is set to [NORMAL]).	Lamp circuit failure, abnormal function or lamp unit is damaged.	
<b>Cause</b>	A message suggesting lamp replacement is displayed when power is turned on.	The power may have been turned on immediately after being turned off.	Lamp circuit failure, abnormal function or lamp unit is damaged.
<b>Solution</b>	Replace the lamp unit. (➡ page 77)	Let the lamp unit cool down and turn on the power.	Press the <OFF> side of the <MAIN POWER> switch to turn off the power as described in the “Switching off the power” procedure (➡ page 29), and contact your dealer.

### Note

- If the <LAMP> indicator is illuminated or flashes despite taking the actions above, please contact an Authorized Service Center to have your projector repaired.

# Care and replacement

## Before cleaning the projector / replacing components

### Attention

- Turn off the <MAIN POWER> switch and disconnect the power plug from the wall outlet before cleaning the projector/replacing components.
- Follow the “Switching off the power” procedure when turning off the projector. (➔ page 29)

## Cleaning the projector

### Cleaning the outer surface of the projector

Wipe off dirt and dust gently with a soft dry cloth.

- If it is difficult to remove the dirt, soak a cloth in water, wring the cloth well and then wipe the projector. Dry the projector with a dry cloth.
- Do not use petroleum benzene, thinner, any alcoholic solvent, or kitchen detergents. Using these substances may result in changes or damage to the surface of the projector.
- When using a chemically treated cloth, follow the accompanying guidelines.

### Cleaning the lens surface

If dirt or dust accumulates on the surface of the lens, it will be enlarged and projected onto the screen.

Wipe dirt and dust from the front of the lens gently with a clean, soft, and dry cloth.

- Do not use a fluffy rag, or a greasy, wet, or dirty cloth.
- Do not rub the lens harshly as this may damage the surface.

### Attention

- The lens is made of glass. It may break or crack if struck with a hard object or rubbed harshly. Please be careful when handling the lamp.

### Air filter unit

If too much dust accumulates in the air filter the internal temperature of the projector cannot be maintained at the normal level. A confirmation message is displayed on the screen, and at the same time <TEMP> illuminates red. The power is cut off automatically after a while. Clean the filter after every 100 hours of usage.

#### 1) Remove the air filter cover.

- Using a Phillips screwdriver to turn the fixing screw of the air filter cover until loose and remove the cover.

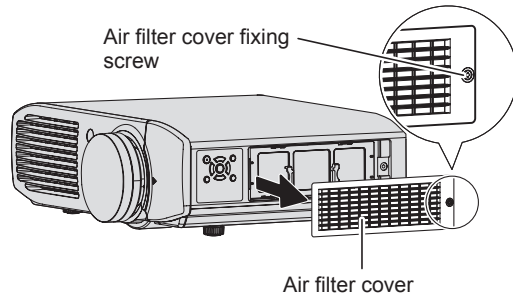

#### 2) Remove the air filter unit.

- Hold the grips on the air filter unit, and remove it from the projector.

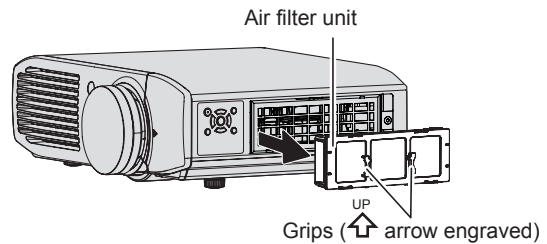

\* After removing the air filter unit, remove any large build ups of dirt or dust in the air filter unit bay and the air intake port on the projector.

#### 3) Vacuum dirt and dust from the air filter unit.

- Do not wash the air filter unit.

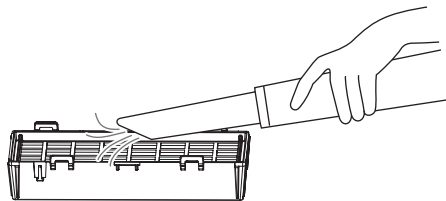

## Care and replacement

### 4) Attach the air filter unit to the projector.

- Attach the air filter unit to the projector using the reverse of the procedure in 2).

\* Insert the air filter unit into the projector in the direction of the arrow engraved into the air filter frame (↑) until it clicks into place.

### 5) Attach the air filter cover, and firmly tighten the air filter cover fixing screw (one) with a Philips screwdriver.

#### Attention

- The air filter unit must always be installed in the projector. Failure to do so will result in malfunctions due to foreign materials, such as dust, entering the projector.
- Do not use water to wash the air filter unit as this decreases its ability to absorb dust.

## Component replacement

### Air filter and electrostatic filter

The air filter should be replaced when cleaning is ineffective.

A replacement air filter / electrostatic filter is available separately (service component).

Contact your dealer for the optional air filter and electrostatic filter.

Also, please replace the air filter and electrostatic filter when replacing the lamp unit.

(An air filter and electrostatic filter are included with the [ET-LAA110] replacement lamp unit.)

### Lamp unit

The lamp unit is a consumable component. See “When to replace the lamp unit” (► page 76) about the lifespan.

Contact your dealer if you wish to purchase a replacement lamp unit (ET-LAA110: Service component).

It is recommended that specialized engineers perform lamp unit replacement. Contact your dealer.

#### Attention

- Wait until the lamp unit has cooled sufficiently before replacing (wait one hour or longer).  
The lamp cover gets very hot, and contact with it can cause burns.

### Before replacing the lamp unit

- A Phillips screwdriver is necessary when carrying out replacement. Hold the screwdriver firmly.
- The light source lamp is a glass component. If it is hit on a hard object or dropped, breakage may occur.  
Be careful when handling a light source lamp.
- Do not disassemble or modify the lamp unit.
- Grip the handle when you remove the lamp unit. Some parts of the lamp unit are sharpened and may cause injury.
- The lamp may be ruptured. Care should be taken not to scatter pieces of the broken lamp glass when replacing the lamp unit.  
Pieces of the broken lamp may fall from the lamp unit especially when the projector is mounted on the ceiling, so when replacing the lamp unit do not stand directly underneath it or position your face close to it.
- The lamp contains mercury. Contact the local government office or distributor for the correct disposal of the old lamp unit.

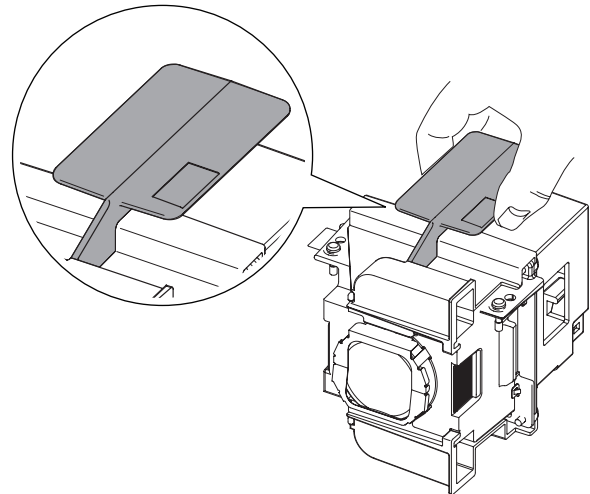



#### Note

- Be sure to use the lamp unit specified.

## Care and replacement

### ■ When to replace the lamp unit

The lamp unit is a consumable component. Brightness decreases according to duration of usage, so periodical replacement of the lamp unit is necessary. A rough estimate for the usage period is 2 000 hours, but depending on the characteristics of individual lamps, usage conditions, periods of continuous use, and environmental conditions etc., the lamp may cease to illuminate prior to reaching 2 000 hours of use. It is recommended that you prepare a spare lamp unit in advance. As the risk of the lamp to cracking increases after 2 000 hours the lamp automatically turns off.

	On screen	Lamp indicator
		
<b>Over 1 800*1 hours</b>	The message is displayed for 30 seconds. If you press any button within the 30 seconds, the message disappears.	Illuminates red, including when in standby mode.
<b>Over 2 000*1 hours</b>	The message is displayed until you press any button.	

\*1: This is the time value for when the lamp is used with [LAMP POWER] in the [OPTION] menu set to [NORMAL] (➡ page 66). Differs from the actual usage time displayed in [LAMP RUNTIME] of the [OPTION] menu. This time increases greatly when [LAMP POWER] is set to [ECO].

#### Note

- Setting [LAMP POWER] to [ECO] results in decreased brightness but the lamp may be used for longer.
- The usage period of 2 000 hours is a rough estimate and is not guaranteed.



## Lamp unit replacement procedure

### Attention

- Once a lamp unit has exceeded its lifespan of 2 000 hours (when [LAMP POWER] is set to [NORMAL]) the projector can only be used for 10 minutes after turning on. (➡ page 76)  
Perform steps 20) to 23) of the procedure within 10 minutes.
- If the projector is installed on the ceiling, do not carry out any replacement procedure directly underneath the lamp unit and keep your face away from the unit.
- Do not open the top cover except when replacing the lamp unit.
- Do not switch the power on while the top cover is opened.
- Always replace the air filter and electrostatic filter whenever replacing the lamp unit.
- Install the lamp unit and the lamp cover securely.

- 1) Press the <OFF> side of the <MAIN POWER> switch to turn off the power as described in the “Switching off the power” procedure (➡ page 29), remove the power plug from the power outlet, and then after an hour or more, check if the area surrounding the lamp unit has cooled down.
- 2) Remove the video cable connected to the connecting terminal.

### Attention

- If you open the top panel fully, it may come into contact with connectors such as the video cable which may result in breakage of the video cable. Before opening the top panel, be sure to remove the connected video cables, etc.

- 3) Hold the protrusions at the front corner of the top cover of the projector and push up to open.

\* When the projector is mounted on the ceiling, stand at the lens side of the projector when opening/closing the top cover.

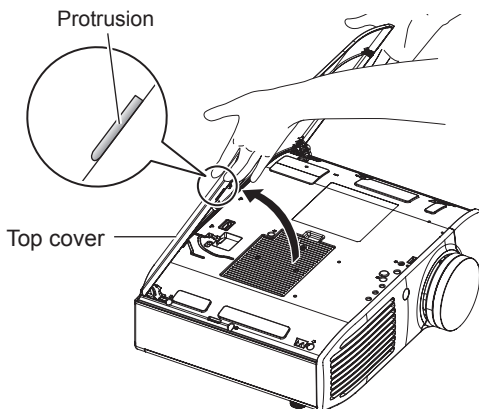

### Attention

- Be careful not to open the top panel too far. For what to do if the top panel comes off, see “Attaching the top cover” (➡ page 79).

- 4) Use a Philips screwdriver to unscrew the lamp cover fixing screw (one) until it becomes loose, and then remove the lamp cover.

\* Slowly remove the lamp cover from the projector.

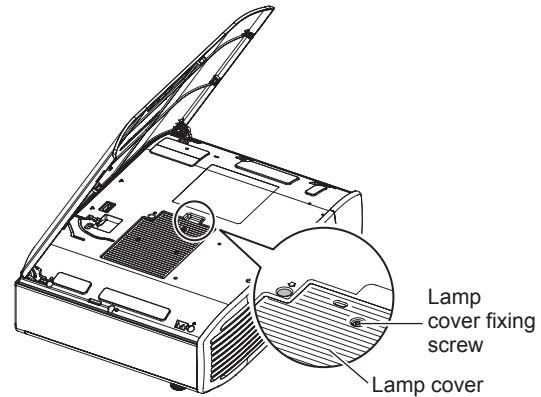

- 5) Use a Phillips screwdriver to unscrew the lamp unit fixing screws (2 screws) until loose.
- 6) Hold the handle of the lamp unit and with the lamp unit lock held in the direction of the black arrow, carefully pull it out of the projector unit in a vertical motion.

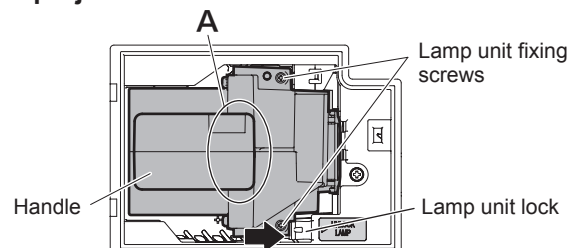

- 7) Replace the new lamp unit while making sure that the direction of insertion is correct. Press the top of the lamp unit downwards and make sure the unit is installed securely. Tighten the lamp unit fixing screws (2 screws) securely with a Phillips screwdriver.

- Press down on the A part firmly when inserting the lamp unit.

- 8) Mount the lamp cover, and tighten the lamp cover fixing screw (one screw) securely with a Phillips screwdriver.
- 9) Close the top cover of the projector.
  - Close the top cover using the reverse of the procedure in 3), and press the center of the top cover.
- 10) Reconnect the video cable disconnected in 2) to the connecting terminal.

# Care and replacement

## 11) Remove the air filter cover.

- Using a Phillips screwdriver to turn the fixing screw of the air filter cover until loose and remove the cover.

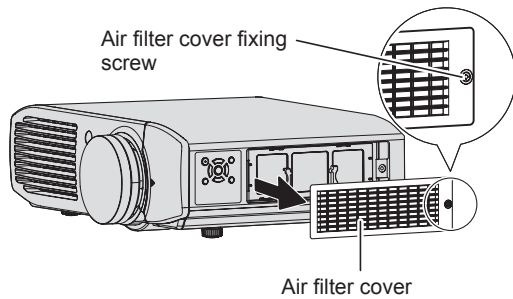

## 12) Remove the air filter unit.

- Hold the grips on the air filter unit, and remove it from the projector.

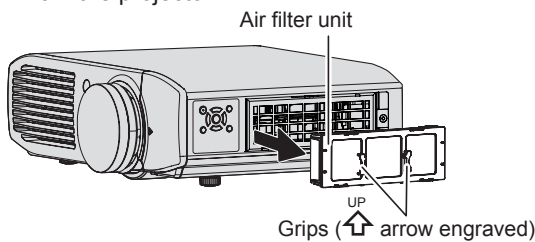

- \* After removing the air filter unit, remove any large build ups of dirt or dust in the air filter unit bay and the air intake port on the projector.

## 13) Press the protrusions of air filter unit removed from the projector in the direction of the black arrow and remove the air filter frame.

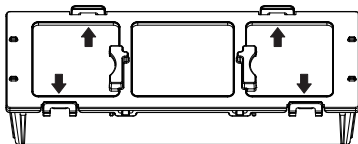

## 14) Replace the air filter/electrostatic filter.

- Replace the air filter and electrostatic filter in the air filter unit with new ones.
- \* Ensure you attach the electrostatic filter and air filter in the correct order.

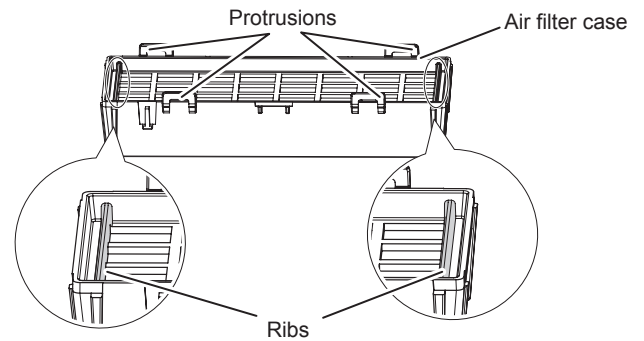
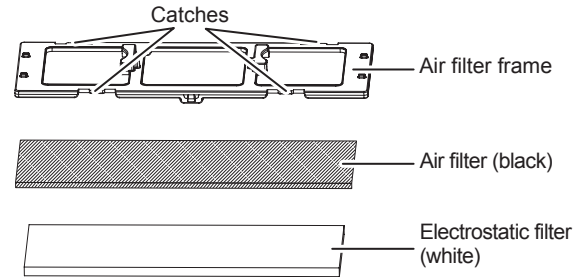

## 15) Assemble the air filter unit.

- First insert the electrostatic filter (white) into the center of the case ensuring that its edges do not ride on top of the ribs, and then insert the air filter (black) so that its four corners are within the case before attaching the air filter frame.
- \* Take care so that the air filter does not get caught between the air filter frame and the case.
- \* Align the catches and protrusions on the air filter case and air filter frame when assembling the air filter unit. When attaching the air filter frame, ensure that the 4 catches are properly aligned with the protrusions on the air filter case and they have clicked into place.

## 16) Attach the air filter unit to the projector.

- Attach the air filter unit to the projector using the reverse of the procedure in 12).
- \* Insert the air filter unit into the projector in the direction of the arrow engraved into the air filter frame (UP) until it clicks into place.

## 17) Attach the air filter cover, and firmly tighten the air filter cover fixing screw (one) with a Philips screwdriver.

## 18) Insert the power plug into a power outlet, and press the <ON> side of the <MAIN POWER> switch to turn on the power.

## 19) Press the power <ON> button on the projector or on the remote control to start video projection.

- 20) Press the <MENU> button to display the menu screen and select [OPTION] with the ▲ ▼ buttons.
- 21) Press the <ENTER> button and select [LAMP RUNTIME] with the ▲ ▼ buttons.
- 22) Hold the <ENTER> button down for 3 seconds.
  - The confirmation message is displayed.

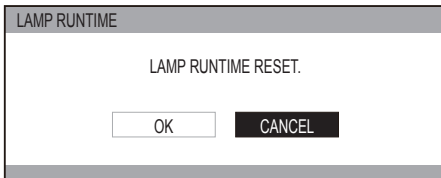

- 23) Select [OK] with the ◀ ▶ buttons and then press the <ENTER> button.
  - LAMP RUNTIME is reset to "0", and the projector powers off. After a short while, the projector enters standby mode.

### ■ Attaching the top cover

Hold the top cover as shown in the diagram below, align the hinge with the support, and while pushing the arm in the direction of the arrow (towards the inner side of the projector), push it into the groove.

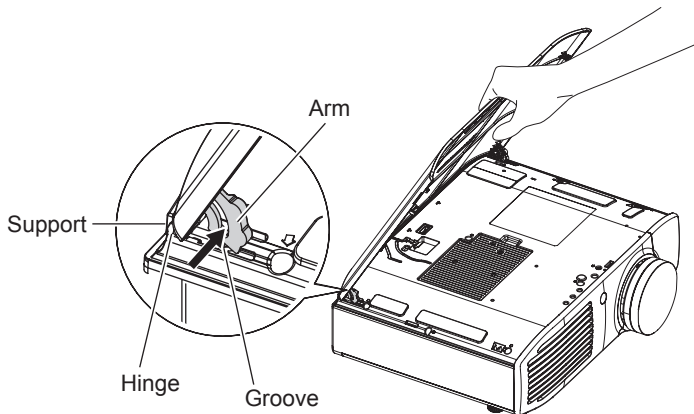

# Troubleshooting

Re-confirm these points.

See the relevant page for details.

Problem	Cause	Page
<b>Power does not turn on.</b>	● The power cord may not be connected.	27
	● The <MAIN POWER> switch is turned <OFF>.	28
	● The wall outlet may not be supplying electricity.	—
	● The circuit breakers may have tripped.	—
	● <TEMP> indicator or <LAMP> indicator is illuminated or flashes.	71
	● The lamp unit may not have been installed correctly.	77
<b>No picture appears.</b>	● The signal input source may not be connected to a terminal properly.	25
	● The input selection setting may not be correct.	33
	● The [BRIGHTNESS] adjustment setting may be at the minimum setting.	37
	● The external device connected to the projector may not be functioning correctly.	—
	● The [BLANK] function may be in use.	70
	● The lens cover may still be attached to the lens.	18
<b>The picture is fuzzy.</b>	● The lens focus may not have been set correctly.	30
	● The projector may not be at the correct distance from the screen.	21
	● The lens may be dirty.	18
	● The projector may be over tilted.	21
<b>The color is pale or grayish.</b>	● [COLOUR] and [TINT] may not be adjusted correctly.	37
	● The device connected to the projector may not be adjusted correctly.	—
<b>The remote control does not work.</b>	● The batteries may have run out.	—
	● The batteries may not have been inserted correctly.	17
	● The remote control signal receiver on the projector may be obstructed.	17
	● The remote control may be out of the range of operation.	17
	● Fluorescent lights may be interfering.	—
<b>The picture does not display correctly.</b>	● [TV-SYSTEM] and [RGB/YC <sub>B</sub> CR.] or [RGB/YP <sub>B</sub> PR.] are not selected correctly.	52, 53
	● There may be a problem with the VCR or other signal source.	—
	● A signal which is not compatible with the projector is being input.	86
<b>Picture from a computer does not appear.</b>	● The cable may be too long. (Cable must be less than 10 m in length.)	—
	● The external video output from a personal computer may not be correct. (You may be able to change the external output settings by pressing the [Fn] + [F3] or [Fn] + [F10] keys simultaneously. The actual method varies depending on the type of computer; refer to the documentation provided with your computer for further details.)	—
<b>Video from HDMI compatible device does not appear or it appears jumbled.</b>	● The HDMI cable is not fully inserted.	26
	● Turn the power for the projector and the external device off and on.	27
	● A signal which is not compatible with the projector is being input.	86

\* If the projector still does not work correctly after checking the points above, contact your dealer.

# Ceiling mount bracket safeguards

- When mounting the projector on the ceiling, use the Panasonic specified ceiling mount bracket (model no.: ET-PKA110H (for high ceilings) and ET-PKA110S (for low ceilings)).
- Installation work of the ceiling mount bracket should only be carried by a qualified technician.
- Even during the guarantee period, the manufacturer is not responsible for any hazard or damage caused by using a ceiling mount bracket which is not purchased from an authorized distributors, or environmental conditions.
- Unused ceiling mount brackets should be removed promptly by a qualified technician.
- Be sure to use a torque driver. Do not use an electrical screwdriver or an impact screwdriver.
- See the installation instructions of the ceiling mount bracket for details.
- The model number of accessories and optional accessories is subject to change without notice.

Bottom view

Model No. of ceiling mount bracket: ET-PKA110H (for high ceiling)  
ET-PKA110S (for low ceiling)

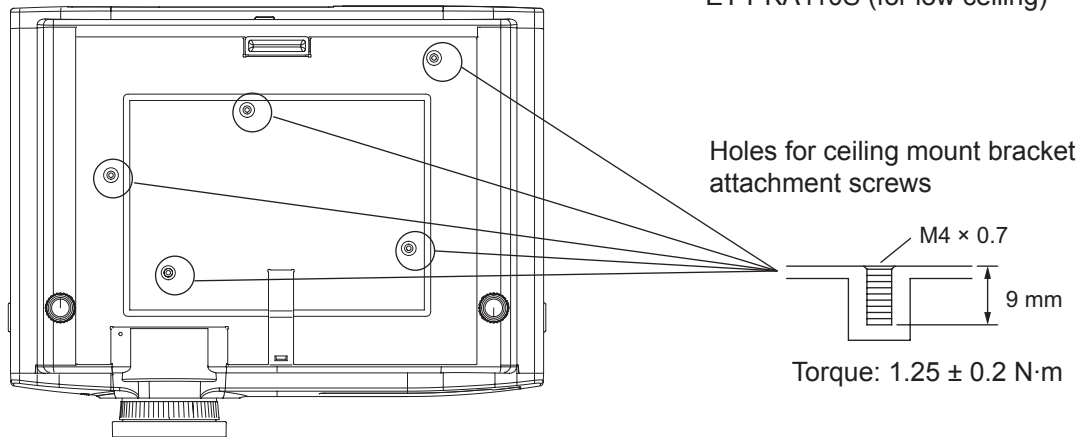

# Using VIERA Link

VIERA Link (HDAVI Control) connects projector and the equipment with VIERA Link function, and enables easy control of the home theatre equipment using the projector remote control.

- This projector supports “HDAVI Control 5” function.  
However, the available features depends on the connected device’s version of HDAVI Control. Please confirm the connected device’s version of HDAVI Control.
- Even with devices from other companies, if it is HDMI specification CEC compatible, there are cases where same function can be used.

## Summary of VIERA Link features

### ■ VIERA Link (HDMI connection only)

Feature \ Connected device	DIGA Recorder with VIERA Link function	DVD Player/ Blu-ray Disk Player with VIERA Link function	HD Video Camera/ LUMIX Camera with VIERA Link function
Easy playback*1	○	○	○
[POWER ON LINK] (➔ page 69)	○	○	○
[POWER OFF LINK] (➔ page 69)	○	○	○
[STANDBY POWER SAVE] (➔ page 69)	○ *3	○ *3	○
[INTELLIGENT AUTO STANDBY] (➔ page 69)	○ *2	○ *2	○
Control the menu of the connected device by projector remote control (➔ page 84)	○ *2	○ *2	○ *2
Speaker control	—	—	—

\*1 : When [POWER ON LINK] (➔ page 69) is [ON], the input of this projector is automatically switched when playback on external devices such as a DIGA begins.

\*2 : Available with a device which has “HDAVI Control 2” or later function.

\*3 : Available with a device which has “HDAVI Control 4” or later function.

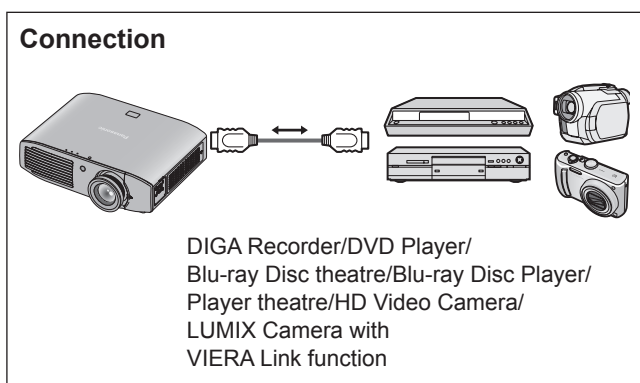

#### Note

- Do not use a cable other than an HDMI High Speed cable that conforms to HDMI standards.
- When connecting the projector and a “VIERA Link” compatible device, connect to the HDMI 1/2 input terminal.
- With regards to Panasonic products other than this projector, check the manual for the device to be connected regarding description for “VIERA Link”.
- VIERA Link can only be used with one display (projector, TV, etc).

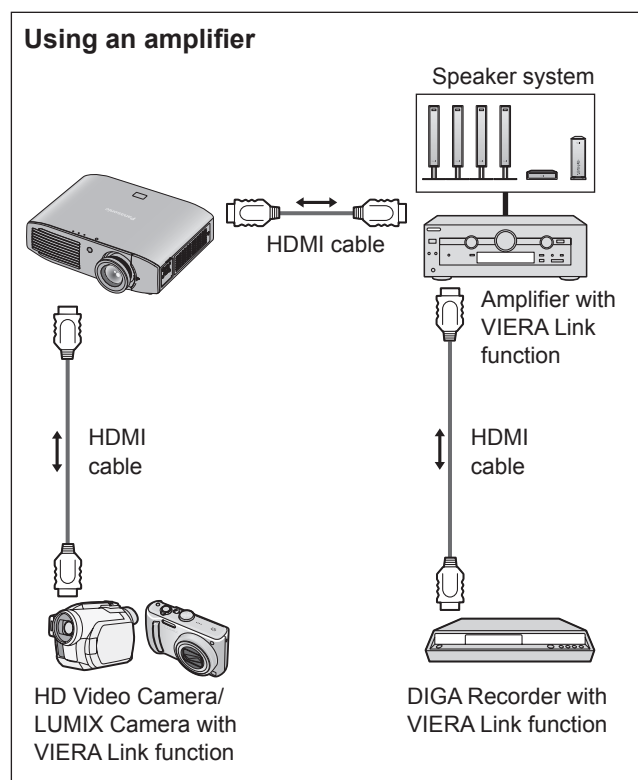

## ■ VIERA Link Control of compatible equipment

“Using [VIERA LINK MENU]” (➡ page 84)

- Table below displays maximum number of compatible equipment that can be controlled by VIERA Link Control. This includes connections to equipment already connected to the projector.  
For example, DIGA Recorder connected to Amplifier which is connected to the projector via an HDMI cable.

Type of the equipment	Maximum number
Recorder (DIGA Recorder, etc.)	3
Player (DVD Player, Blu-ray Disc Player, HD Video Camera, LUMIX Camera, Digital Camera, Player theatre, Blu-ray Disc theatre, etc.)	3
Audio system (Player theatre, Blu-ray Disc theatre, Amplifier, etc.)	1
Tuner (Set top box, etc.)	4

## VIERA Link “HDAVI Control”

Connections to the equipment (DIGA Recorder, HD Video Camera, Player theatre, Amplifier, etc.) with HDMI cables allow you to interface them automatically.

These features are limited to models incorporating “HDAVI Control” and “VIERA Link”.

- Some functions are not available depending on the equipment’s version of HDAVI Control.  
Please confirm the connected equipment’s version of HDAVI Control. But some functions will not be able to perform even if the versions are the same.
- VIERA Link “HDAVI Control”, based on the control functions provided by HDMI which is an industry standard known as HDMI CEC (Consumer Electronics Control), is a unique function that we have developed and added.  
As such, its operation with other manufacturers’ equipment that supports HDMI CEC cannot be guaranteed.
- Please refer to individual manuals for other manufacturers’ equipment supporting Link function.
- About applicable Panasonic equipment, consult your local Panasonic dealer.

## ■ Preparations

- Use fully wired HDMI compliant cable. Non-HDMI-compliant cables cannot be utilized.
- Set up the connected equipment.  
**Switch the connected equipment on.**  
**Set [POWER ON LINK] in the setup menu.**  
(Please read the manual of the equipment for these setup.)
- Set up the projector.  
**Switch the projector on.**  
**Set the input mode to [HDMI 1 IN], [HDMI 2 IN], and make sure that an image is displayed correctly.**  
**Select [VIERA LINK SETTINGS] in the [OPTION] menu.**  
**If the [VIERA LINK] is set to [ON], you need to select [OFF] first, and then switch to [ON] again to activate the [ON] setting.**

### Note

- This setup should be done each time when the following conditions occur:
  - When using for the first time
  - When adding or reconnecting equipment
  - When changing setup



# Using VIERA Link

## Using [VIERA LINK MENU]

You can control some functions of the connected device with the controls or remote control of this projector.

- If operation is not possible, check the settings of the device.
- For details on operating an external device, see the manual of the relevant device.

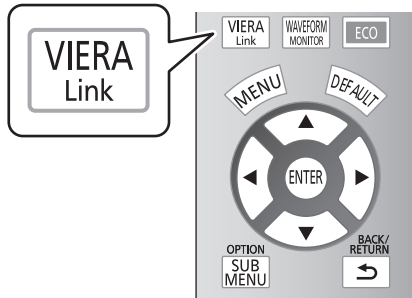

Press the <VIERA Link> button. Alternatively, select [VIERA LINK MENU] from [OTHER FUNCTIONS] in the [OPTION] menu, and then press the <ENTER> button.

- The [VIERA LINK MENU] menu is displayed.

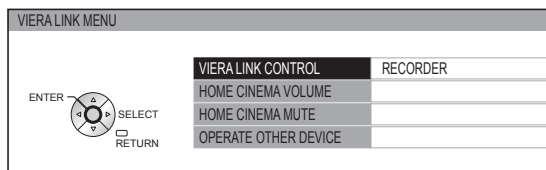

## Access and operate the menu of the equipment

- 1) Select [VIERA LINK CONTROL] with the ▲▼ buttons.
- 2) Select the type of the device to be connected with the ◀▶ buttons.
- 3) Press the <ENTER> button.

(RECORDER / PLAYER / HOME CINEMA / VIDEO CAMERA / LUMIX / DIGITAL CAMERA / OTHER)

- [HOME CINEMA] is a system that includes the projector, an audio output device, and a video output device.
- [OTHER] indicates tuner (such as the set top box)

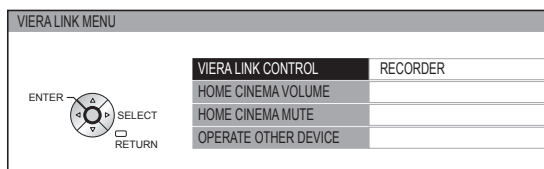

**The menu of the accessed device appears.**  
(The input mode switches automatically.)

## 4) Use the menu of the device.

- You can use the controls of the projector as well as the buttons on the remote control. (The functions that you can use depend on the connected device.)

### If you access a device other than a VIERA Link device

VIERA LINK CONTROL RECORDER 1

The type of the connected device is displayed.

You can access the menu of the device, but cannot use it. Use the remote control of the device to operate it.

### If multiple recorders or players are connected

You can connect up to three recorders or players at the same time.

VIERA LINK CONTROL RECORDER 1

#### Recorder 1 - 3 / Player 1 - 3

Devices of the same type connected to the HDMI terminals (1/2) on this projector are registered in an order starting from the smallest number.

For example, if two recorders are connected to HDMI 1 and HDMI 2 respectively, the recorder connected to HDMI 1 is displayed as [RECORDER 1], and the recorder connected to HDMI 2 is displayed as [RECORDER 2].

### Note

- Some operations may not be available depending on the device. In this case, use its own remote control to operate the device.  
(The colored buttons operations, such as changing the date of TV program for Blu-ray Disc Recorder cannot be controlled by the projector remote control.)



## ● [HOME CINEMA VOLUME]

You can adjust the volume of the cinema speaker with the projector remote control.

- If the volume cannot be adjusted, check the settings of the device.

- 1) Select [HOME CINEMA VOLUME] with the ▲▼ buttons.

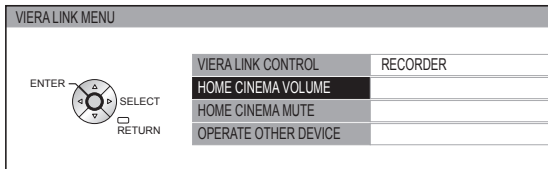

- 2) Press the <ENTER> button.

- The volume adjustment bar appears.



### Note

- The design of the volume adjustment bar may differ depending on the connected device.

- 3) Press the ◀▶ buttons to adjust the volume of the device.

### Note

- The speaker functions may not work properly depending on the connected device.
- The image or sound may not be available for the first few seconds after the input mode is switched.
- HDAVI Control 5 is the latest Panasonic standard (current as of August, 2011) for HDAVI Control compatible devices.

## ● [HOME CINEMA MUTE]

You can mute cinema speakers using the projector remote control.

- If you cannot mute the speakers, check the settings of the device.

- 1) Select [HOME CINEMA MUTE] with the ▲▼ buttons.

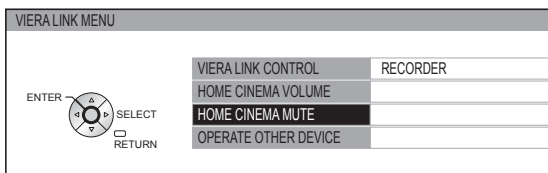

- 2) Press the <ENTER> button.

- Press the <ENTER> button again to cancel the mute.

## ● [OPERATE OTHER DEVICE]

When displaying videos using HDMI input from a third party external device that supports VIERA Link, you can display the remote control screen and control the external device with the projector remote control.

- 1) Select [OPERATE OTHER DEVICE] with the ▲▼ buttons.

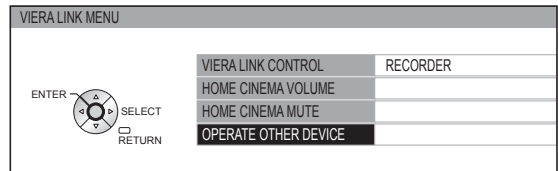

- 2) Press the <ENTER> button.

- A remote control image appears on the screen. Use this image to operate the device.



# Technical information

## List of compatible signals

The following table specifies the types of signals compatible with the projectors.

Format: V: VIDEO, S: S-VIDEO, R: RGB, Y: YC<sub>B</sub>CR/YP<sub>B</sub>PR, H: HDMI

Mode	SIGNAL MODE	Display resolution (dots) <sup>*1</sup>	Scanning frequency		Dot clock frequency (MHz)	Format	Plug and play compatible HDMI	
			H (kHz)	V (Hz)				
NTSC/NTSC 4.43/ PAL-M/PAL60	—	720 × 480i	15.7	59.9	—	V/S	—	
PAL/PAL-N/SECAM	—	720 × 576i	15.6	50.0	—		—	
525i (480i)	480i	720 × 480i	15.7	59.9	13.5	R/Y	—	
625i (576i)	576i	720 × 576i	15.6	50.0	13.5		—	
525p (480p)	480p	720 × 483	31.5	59.9	27.0	R/Y/H	○	
625p (576p)	576p	720 × 576	31.3	50.0	27.0		○	
750 (720)/60p	720/60p	1 280 × 720	45.0	60.0	74.3		○	
750 (720)/50p	720/50p	1 280 × 720	37.5	50.0	74.3		○	
1 125 (1 080)/60i	1 080/60i	1 920 × 1 080i	33.8	60.0	74.3		○	
1 125 (1 080)/50i	1 080/50i	1 920 × 1 080i	28.1	50.0	74.3		○	
1 125 (1 080)/24p	1 080/24p	1 920 × 1 080	27.0	24.0	74.3		○	
1 125 (1 080)/60p	1 080/60p	1 920 × 1 080	67.5	60.0	148.5		○	
1 125 (1 080)/50p	1 080/50p	1 920 × 1 080	56.3	50.0	148.5		○	
VGA	VGA60	640 × 480	31.5	59.9	25.2		R	—
	VGA75	640 × 480	37.5	75.0	31.5			—
	VGA85	640 × 480	43.3	85.0	36.0			—
SVGA	SVGA56	800 × 600	35.2	56.3	36.0	—		
	SVGA60	800 × 600	37.9	60.3	40.0	—		
	SVGA72	800 × 600	48.1	72.2	50.0	—		
	SVGA75	800 × 600	46.9	75.0	49.5	—		
	SVGA85	800 × 600	53.7	85.1	56.3	—		
XGA	XGA60	1 024 × 768	48.4	60.0	65.0	—		
	XGA70	1 024 × 768	56.5	70.1	75.0	—		
	XGA75	1 024 × 768	60.0	75.0	78.8	—		
	XGA85	1 024 × 768	68.7	85.0	94.5	—		
MXGA	MXGA70	1 152 × 864	64.0	70.0	94.2	—		
	MXGA75	1 152 × 864	67.5	74.9	108.0	—		
1 280 × 720	1 280 × 720/60	1 280 × 720	44.8	59.9	74.5	—		
1 280 × 768	1 280 × 768/60	1 280 × 768	47.8	59.9	79.5	—		
1 280 × 800	1 280 × 800/60	1 280 × 800	49.7	59.8	83.5	—		
SXGA	SXGA60	1 280 × 1 024	64.0	60.0	108.0	—		
SXGA+	SXGA+60	1 400 × 1 050	65.2	60.0	122.6	—		
WXGA+	WXGA+60	1 440 × 900	55.9	59.9	106.5	—		
1 920 × 1 080	1 920 × 1 080/60	1 920 × 1 080 <sup>*2</sup>	66.6	59.9	138.5	—		
	1 920 × 1 080/50	1 920 × 1 080	55.6	49.9	141.5	—		
WUXGA	WUXGA60RB	1 920 × 1 200 <sup>*2</sup>	74.0	60.0	154.0	—		

\*1 : The “i” displayed after the resolution indicates an interlaced signal.

\*2 : VESA CVT-RB (Reduced Blanking) compatible.

### Note

- The number of display dots for the PT-AR100EA display is 1 920 x 1 080.  
A signal with a different resolution will be projected after converting the resolution to match the projector display.
- When interlaced signals are connected, flicker may occur on the projected image.

## Serial terminal

The serial port on the connector panel of the projector conforms to the RS-232C interface specification, so the projector can be controlled by a personal computer connected to this port.

### ■ Connection

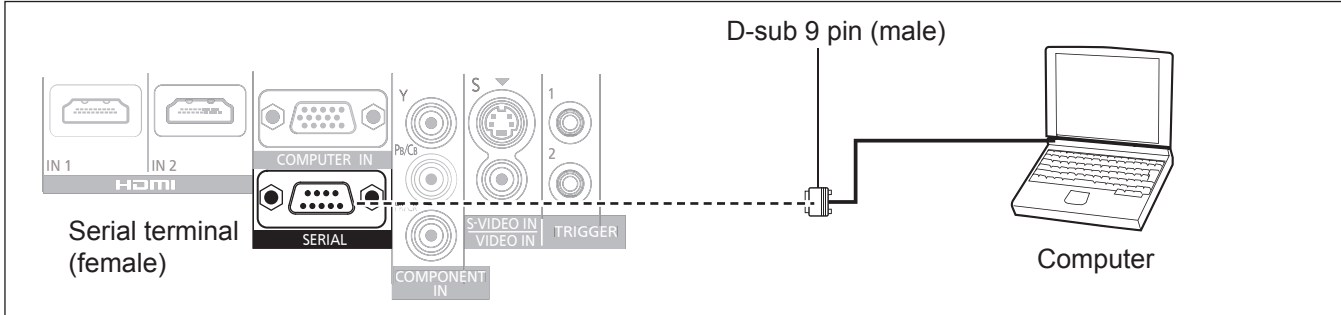

### ■ Pin assignments and signal names

D-Sub 9 Pin (external view)	Pin No.	Signal name	Contents
	(1)	—	NC
	(2)	TXD	Transmitted data
	(3)	RXD	Received data
	(4)	—	NC
	(5)	GND	Earth
	(6)	—	NC
	(7)	RTS	Connected internally
	(8)	CTS	
	(9)	—	NC

### ■ Communication settings

Signal level	RS-232C
Sync. method	Asynchronous
Baud rate	9 600 bps
Parity	None

Character length	8 bits
Stop bit	1 bit
X parameter	None
S parameter	None

### ■ Basic format

<table border="1"> <tr> <td>STX</td> <td>Command</td> <td>:</td> <td>Parameter</td> <td>ETX</td> </tr> <tr> <td>Start byte (02h)</td> <td>3 bytes</td> <td>1 byte</td> <td>1 byte - 4 bytes</td> <td>End (03h)</td> </tr> </table>	STX	Command	:	Parameter	ETX	Start byte (02h)	3 bytes	1 byte	1 byte - 4 bytes	End (03h)	<p>Data streaming from the computer will start with STX, and proceed to command, parameter and end with ETX. Parameters can be added as necessary.</p>
STX	Command	:	Parameter	ETX							
Start byte (02h)	3 bytes	1 byte	1 byte - 4 bytes	End (03h)							

### Attention

- The projector cannot receive any command for 10 seconds after the lamp is switched on. Wait 10 seconds before sending a command.
- If sending multiple commands, check that a response has been received from the projector for one command before sending the next.
- When a command which does not require parameters to be sent, a colon (:) is not required.

### Note

- If an incorrect command is sent, the ER401 command will be sent from the projector to the personal computer.

# Technical information

## ■ Cable specifications

(When connected to a personal computer)

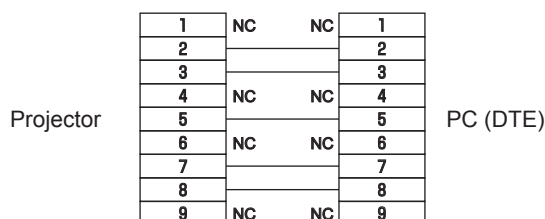

## ■ Control commands

Commands available when controlling this projector from a computer are as follows.

<Operation commands>

Command	Control contents	Remarks
PON	POWER ON	In standby mode, all commands other than the PON command are ignored.
POF	POWER OFF	The PON command is ignored during lamp on control. ● If a PON command is received while the cooling fan is operating after the lamp has switched off, the lamp is not turned back on unless approximately 85 seconds have passed in order to protect the lamp.
IIS	SWITCH INPUT	Parameters CP1 = COMPONENT IN SVD = S-VIDEO IN VID = VIDEO IN HD1 = HDMI 1 IN HD2 = HDMI 2 IN RG1 = COMPUTER IN
OMN	MENU	Displays the main menu.
OEN	ENTER	Activates the selected items in the menu mode.
OBK	RETURN	Returns to the previous menu or escaping from the menu mode.
OCU OCD OCL OCR	Navigation buttons (▲▼◀▶)	OCU = ▲ cursor                      OCD = ▼ cursor OCL = ◀ cursor                      OCR = ▶ cursor
OST	DEFAULT	Resets to the factory default setting. (➡ page 32)
OFZ	FREEZE	Freezes the projected screen. (➡ page 70) 0 = OFF, 1 = ON
FC1	FUNCTION BUTTON	Activates the function allocated to the <FUNCTION> button of the remote control.
OSH	BLANK	Turns off the projection temporarily. Sends the command to switch between ON and OFF. (➡ page 70) Do not rapidly switch between ON/OFF. While the BLANK function is ON, it is switched OFF when any command is received.
OVM	PICTURE	Activates the [PICTURE] menu. Send the command to switch menu items. (➡ page 37)
OWM	WAVEFORM	Parameter 0 = OFF 1 = FULL SCAN(Y) 2 = FULL SCAN(R) 3 = FULL SCAN(G) 4 = FULL SCAN(B) 5 = SINGLE LINE SCAN(Y) 6 = SINGLE LINE SCAN(R) 7 = SINGLE LINE SCAN(G) 8 = SINGLE LINE SCAN(B)
VS1	ASPECT	Switches the aspect ratio. Aspect ratio is switched each time this command is sent. (➡ page 56)
VPM	PICTURE MODE	Switches the [PICTURE MODE]. (➡ page 37) Parameter NOR = NORMAL DYN = DYNAMIC GM1 = GAME SP = SPORTS 709 = REC709 CN1 = CINEMA1 VCN = VIVID CINEMA
OOT	SLEEP	Sets the duration of time after which the power is to be turned off automatically. (➡ page 68) 0 = OFF 1 = 60MIN. 2 = 90MIN. 3 = 120MIN. 4 = 150MIN. 5 = 180MIN. 6 = 210MIN. 7 = 240MIN.
OEC	ECO MANAGEMENT	Displays the [ECO MANAGEMENT] menu.

Command	Control contents	Remarks
VXX	GAMMA ADJUSTMENT	Sets Y ADJUST. (OUTPUT) AGOS0 = p1p2d1d2d3d4 p1p2 = POINT (01 - 09) <span style="float: right;">d1d2d3d4 = OUTPUT (0000 - 0255)</span>
		Sets R ADJUST. (OUTPUT) AGOS1 = p1p2d1d2d3d4 p1p2 = POINT (01 - 09) <span style="float: right;">d1d2d3d4 = OUTPUT (0000 - 0255)</span>
		Sets G ADJUST. (OUTPUT) AGOS2 = p1p2d1d2d3d4 p1p2 = POINT (01 - 09) <span style="float: right;">d1d2d3d4 = OUTPUT (0000 - 0255)</span>
		Sets B ADJUST. (OUTPUT) AGOS3 = p1p2d1d2d3d4 p1p2 = POINT (01 - 09) <span style="float: right;">d1d2d3d4 = OUTPUT (0000 - 0255)</span>
		Sets GAMMA ADJUSTMENT. (INPUT) AGIS0 = p1p2d1d2d3 p1p2 = POINT (01 - 09) <span style="float: right;">d1d2d3 = INPUT (001 - 099)</span>
	TRIGGER 1 (OUTPUT)	Switches TRIGGER 1 (OUTPUT) when RS-232C COMMAND LINK is set in the TRIGGER 1 SETTING menu. TROIO = +00000 = LOW <span style="float: right;">TROIO = +00001 = HIGH</span>
TRIGGER 2 (OUTPUT)	Switches TRIGGER 2 (OUTPUT) when RS-232C COMMAND LINK is set in the TRIGGER 2 SETTING menu. TROI1 = +00000 = LOW <span style="float: right;">TROI1 = +00001 = HIGH</span>	

## <Inquiry commands>

Command	Control contents	Parameter
QPW	Power status	000 = OFF <span style="float: right;">001 = ON</span>
QIN	INPUT signal status	CP1 = COMPONENT IN SVD = S-VIDEO IN VID = VIDEO IN HD1 = HDMI 1 IN HD2 = HDMI 2 IN RG1 = COMPUTER IN
QPM	PICTURE MODE status	NOR = NORMAL DYN = DYNAMIC GM1 = GAME SP = SPORTS 709 = REC709 CN1 = CINEMA1 VCN = VIVID CINEMA (➡ page 37)
QSH	BLANK status	0 = OFF <span style="float: right;">1 = ON (➡ page 70)</span>
QFZ	FREEZE status	0 = OFF <span style="float: right;">1 = ON (➡ page 70)</span>
QOT	OFF TIMER status	0 = OFF 1 = 60MIN. 2 = 90MIN. 3 = 120MIN. 4 = 150MIN. 5 = 180MIN. 6 = 210MIN. 7 = 240MIN. (➡ page 68)
QWM	WAVEFORM status	Parameter 0 = OFF 1 = FULL SCAN(Y) 2 = FULL SCAN(R) 3 = FULL SCAN(G) 4 = FULL SCAN(B) 5 = SINGLE LINE SCAN(Y) 6 = SINGLE LINE SCAN(R) 7 = SINGLE LINE SCAN(G) 8 = SINGLE LINE SCAN(B)

# Specifications

The following table describes the specifications of the projector.

<b>Power supply</b>		AC100 V - 240 V 50 Hz/60 Hz
<b>Power consumption</b>		Less than 350 W During standby (when fan is stopped): 0.08 W
<b>Amps</b>		4.2 A - 1.5 A
<b>LCD panel</b>	<b>Panel size (diagonal)</b>	18.7 mm (0.74")
	<b>Aspect ratio</b>	16 : 9
	<b>Display method</b>	3 transparent LCD panels (RGB)
	<b>Drive method</b>	Active matrix method
	<b>Pixels</b>	2 073 600 (1 920 x 1 080) x 3 panels
<b>Lens</b>		Manual zoom (2x)/Manual focus F 2.0 - 3.4, f 21.5 mm - 43.0 mm
<b>Lamp</b>		UHM lamp (280 W)
<b>Luminosity<sup>*1</sup></b>		2 800 lm
<b>Operating environment</b>		Temperature 0 °C - 40 °C (32 °F - 104 °F) When [HIGH ALTITUDE MODE] (▶ page 66) is set to [ON]: 0 °C - 35 °C (32 °F - 95 °F)
		Humidity 20% - 80% (no condensation)
<b>Scanning frequency<sup>*2</sup> (for RGB signal)</b>	<b>Horizontal scanning frequency</b>	15 kHz - 74 kHz
	<b>Vertical scanning frequency</b>	24 Hz - 85 Hz
	<b>Dot clock frequency</b>	Less than 154 MHz
<b>COMPONENT (YP<sub>B</sub>P<sub>R</sub>) signals</b>		525i (480i), 625i (576i), 525p (480p), 625p (576p), 750 (720)/60p, 750 (720)/50p, 1 125 (1 080)/60i, 1 125 (1 080)/50i, 1 125 (1 080)/60p, 1 125 (1 080)/50p, 1 125 (1 080)/24p
<b>Color system</b>		7 (NTSC/NTSC 4.43/PAL/PAL-M/PAL-N/PAL60/SECAM)
<b>Projection size</b>		1.02 m - 7.62 m (40" - 300")
<b>Projection distance</b>		1.1 m - 17.5 m (3'8" - 57'3") (16:9 size)
<b>Screen aspect ratio</b>		16 : 9
<b>Installation</b>		FRONT/DESK, FRONT/CEILING, REAR/DESK, REAR/CEILING (Menu selection method)

\*1. Measurement, measuring conditions and method of notation all comply with ISO21118 international standards.

\*2. For details of video signals that can be projected with this projector, see the "List of compatible signals" (▶ page 86).

<b>Terminals</b>	<b>S-VIDEO IN</b>	1 set, Mini DIN 4p Y: 1.0 V [p-p], C: 0.286 V [p-p], 75 Ω	
	<b>VIDEO IN</b>	1 set, RCA pin jack 1.0 V [p-p], 75Ω	
	<b>COMPUTER IN</b>	1 set, D - sub HD 15-pin (female) (RGB signal)	
		R.G.B.	0.7 V [p-p], 75 Ω
		G.SYNC	1.0 V [p-p], 75 Ω
		HD/SYNC*1	TTL high impedance, automatic positive/negative polarity compatible
	VD*1	TTL high impedance, automatic positive/negative polarity compatible	
	(Y, P <sub>B</sub> /C <sub>B</sub> , P <sub>R</sub> /C <sub>R</sub> signal)		
Y:	1.0 V [p-p] (including sync), 75 Ω		
P <sub>B</sub> /C <sub>B</sub> , P <sub>R</sub> /C <sub>R</sub>	0.7 V [p-p], 75 Ω		
<b>COMPONENT IN</b>	1 set, RCA pin jack x 3		
	Y:	1.0 V [p-p] (including sync), 75 Ω	
	P <sub>B</sub> /C <sub>B</sub> , P <sub>R</sub> /C <sub>R</sub>	0.7 V [p-p], 75 Ω	
<b>HDMI IN</b>	2 sets, 19-pin HDMI connector (HDCP/HDAVI Control Ver. 5 compliant)		
<b>SERIAL</b>	1 set, D-sub 9-pin RS-232C compatible		
<b>TRIGGER</b>	2 sets, monaural mini jack DC 12 V, max.100 mA (Selectable for input and output by menu operation.)		
<b>Cabinet</b>	Moulded plastic (PC+ABS)		
<b>Dimensions</b>	Width	470 mm (18 1/2")	
	Height	151 mm (5 15/16")	
	Depth	380 mm (14 31/32")	
<b>Weight</b>	Approx. 8.6 kg (18.96 lbs.)*2		
<b>Certifications</b>	EN60950-1, EN55022, EN61000-3-2, EN61000-3-3, EN55024		
<b>Remote control</b>	<b>Power supply</b>	DC 3 V (AA/R6/LR6 battery x 2)	
	<b>Operating range</b>	Approx. 7 m (23') (when operated directly in front of signal receptor)	
	<b>Weight</b>	125 g (4.4 ozs.) (including batteries)	
	<b>Dimensions</b>	Width	48 mm (1 7/8")
		Length	138 mm (5 7/16")
Height		28.3 mm (1 1/8") (not including surface projection parts)	

\*1. HD/SYNC, and VD terminals do not accept tri-level sync signals.

\*2. Average value. Weight varies for each product.

# Specifications

## Dimensions

Unit: mm

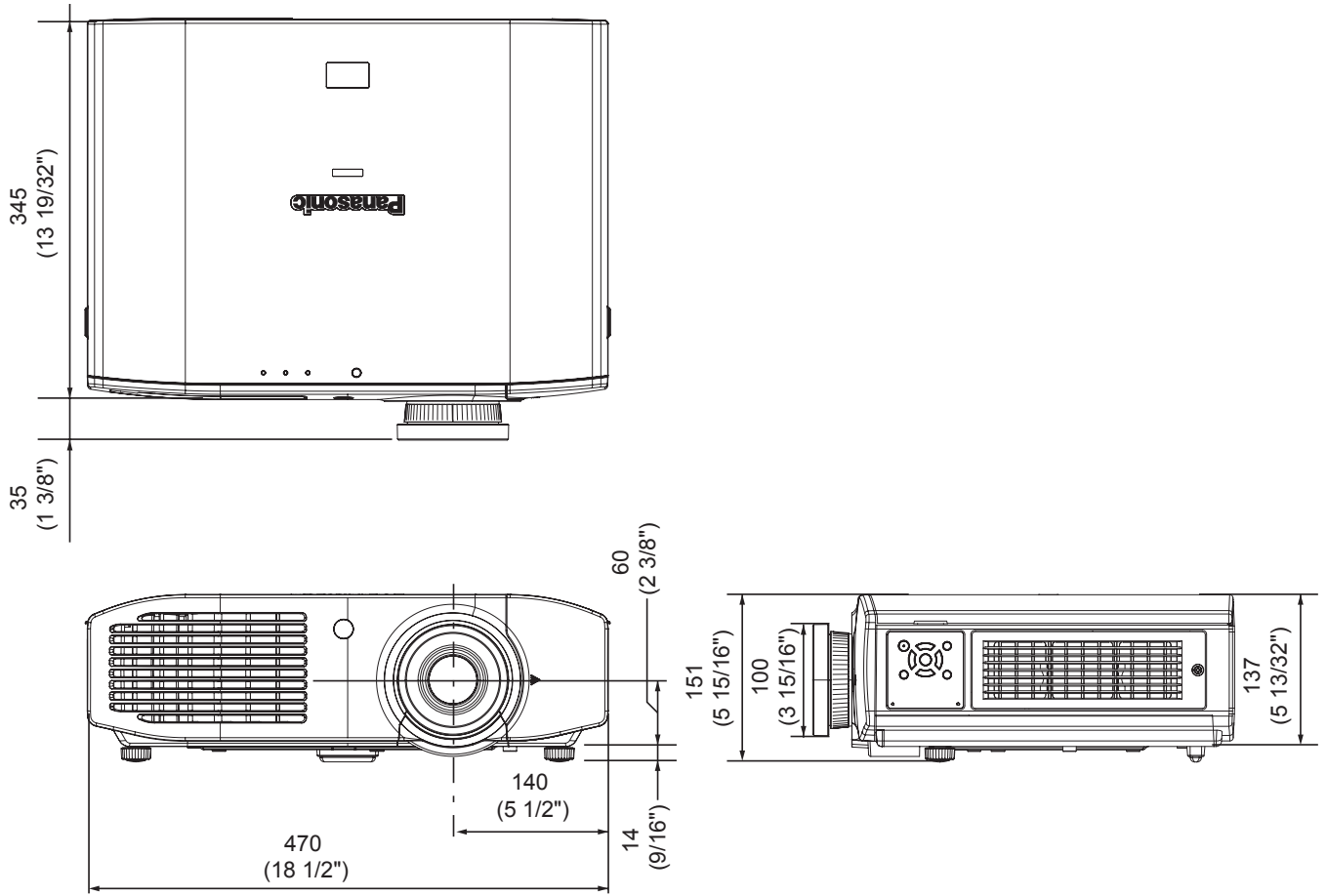



# Index

<b>A</b>			
About your projector	17		
Accessories	16		
Adjusting the picture	31		
ADVANCED MENU	42		
Air filter	75		
Air filter unit	73		
AMBIENT LIGHT DETECTION	67		
ASPECT	56		
Attaching the top cover	79		
AUTO POWER SAVE	67		
AUTO SEARCH	64		
AUTO SETUP	58		
AUTO SWITCHING	61		
<b>B</b>			
BACK COLOUR	63		
BLANK	70		
BLANK DETECTION	67		
BRIGHTNESS	37, 46		
<b>C</b>			
Cautions on use	15		
Cautions when installing	13		
Cautions when transporting	13		
Ceiling mount bracket safeguards	81		
CINEMA REALITY	52		
Cleaning	73		
CLOCK PHASE	55		
COLOUR	37		
COLOUR MANAGEMENT	47		
COLOUR TEMPERATURE	38		
Compatible signals	86, 90		
Connections	25		
CONTRAST	37, 46		
Control commands	88		
<b>D</b>			
DETAIL CLARITY	52		
Dimensions	92		
Displaying the waveform monitor	32		
Disposal	15		
DOT CLOCK	55		
DYNAMIC IRIS	38		
<b>E</b>			
ECO MANAGEMENT	33, 67		
Electrostatic filter	75		
<b>F</b>			
FRAME RESPONSE	64		
FREEZE	70		
Front adjustable feet	22		
FUNCTION	33		
FUNCTION BUTTON	68		
<b>G</b>			
GAMMA ADJUSTMENT	42		
<b>H</b>			
H-AREA POSITION	61		
HDMI SIGNAL LEVEL	64		
HIGH ALTITUDE MODE	66		
H-POSITION	55		
<b>I</b>			
Illuminating button lights	31		
INPUT GUIDE	63		
INTELLIGENT AUTO STANDBY	69		
<b>K</b>			
KEYSTONE	58		
<b>L</b>			
Lamp indicator <LAMP>	72		
LAMP POWER	66		
LAMP RUNTIME	70		
Lamp unit	75		
LANGUAGE	36		
LEFT MASKING AREA	62		
Lens shift	23		
LIGHT HARMONIZER	38		
Loading a saved setting	32		
LOWER MASKING AREA	62		
<b>M</b>			
MEMORY DELETE	54		
MEMORY EDIT	60		
MEMORY LOAD	54, 59		
MEMORY NAME CHANGE	54		
MEMORY SAVE	53, 59		
MENU	34		
Menu list	35		
Menu navigation	34		
MOTION EFFECT	47		
MPEG NR	46		
<b>N</b>			
NR	46		
<b>O</b>			
ON-SCREEN DISPLAY	63		
OPTION	36		
Optional accessories	16		
OSD DESIGN	63		
OSD POSITION	63		
OTHER FUNCTIONS	70		
OVER SCAN	58		
<b>P</b>			
Part replacement	73		
PICTURE	35		
PICTURE MEMORY	53		
PICTURE MODE	37		
POSITION	35		
Positioning	23		
Power cord	27		
Power indicator	27		
POWER OFF LINK	69		
POWER ON LINK	69		
Precautions for use	13		
Projecting an image	30		
Projection method	20		
PROJECTION METHOD	64		
Projection related	21		
Projector body	18		
<b>R</b>			
Read this first!	6		
Remote control	17, 31		
Resetting to the default settings	32		
RGB/YC <sub>B</sub> C <sub>R</sub>	53		
RGB/YP <sub>B</sub> PR	53		
RIGHT MASKING AREA	62		
<b>S</b>			
SCREEN AREA MEMORY	59		
Selecting the picture mode	31		
Serial terminal	87		
Setting up	20		
SHARPNESS	38		
SIGNAL DETECTION	67		
SIGNAL MODE	54		
SLEEP	68		
Specifications	90		
SPLIT ADJUST	41		
STANDBY POWER SAVE	69		
STARTUP LOGO	64		
Submenu	33		
Switching the projector on/off	27		
Switch input	33		
<b>T</b>			
Temperature indicator <TEMP>	71		
TEST PATTERN	70		
TINT	37		
TRIGGER 1/2 SETTING	65		
Troubleshooting	80		
TV-SYSTEM	52		
<b>U</b>			
UPPER MASKING AREA	62		
Using VIERA Link	82		
<b>V</b>			
V-AREA POSITION	61		
VIERA LINK	68		
VIERA LINK MENU	32, 70		
VIERA LINK SETTINGS	68		
V-POSITION	55		
<b>W</b>			
WAVEFORM MONITOR	39		
WSS	58		
<b>X</b>			
x.v.Colour	52		

## Information on Disposal in other Countries outside the European Union



These symbols are only valid in the European Union.  
If you wish to discard this product, please contact your local authorities or dealer and ask for the correct method of disposal.



EU

