

“i-PRO SmartHD solutions”

Smart investment with more than just video surveillance.....

Better identification with more evidence

Smart investments to lower your TCO

More than just video surveillance

Distinctive and versatile industry product solutions

i-PRO
SmartHD Solutions

Trademarks and registered trademarks

- HDMI, the HDMI logo and High-Definition Multimedia Interface are trademarks or registered trademarks of HDMI Licensing, LLC.
- “Super Dynamic”, “i-PRO” and “i-PRO SmartHD” logos are trademarks or registered trademarks of Panasonic Corporation.
- iPad, iPhone and iPod touch are registered trademarks of Apple Inc.
- Android is a trademark of Google Inc.
- All other trademarks identified herein are the property of their respective owners.
- ONVIF and the ONVIF logo are trademarks of ONVIF Inc.

Important

- Safety Precaution: Carefully read the Important Information, Installation Guide and operating instructions before using this product.
- Panasonic cannot be responsible for the performance of the network and/or other manufacturers' products used on the network.
- The same catalog is provided for all countries. Some accessories may not be available in some countries.
- UniPhier is Panasonic's proprietary System LSI platform.

Security Cautions

- When using the products in this catalog, take appropriate measures to avoid the following security breaches:
 - Disclosure of private information via the products.
 - Unauthorized use of products by a third party.
 - Interference or suspension of use of products by third party.

- All pictures are simulated.
- Masses and dimensions are approximate.
- Design and specifications are subject to change without notice.
- These products may be subject to export control regulations.

DISTRIBUTED BY:

Panasonic

<http://security.panasonic.com>

[f http://www.facebook.com/PanasonicNetworkCamera](http://www.facebook.com/PanasonicNetworkCamera)

Printed in Japan (5A-002D)

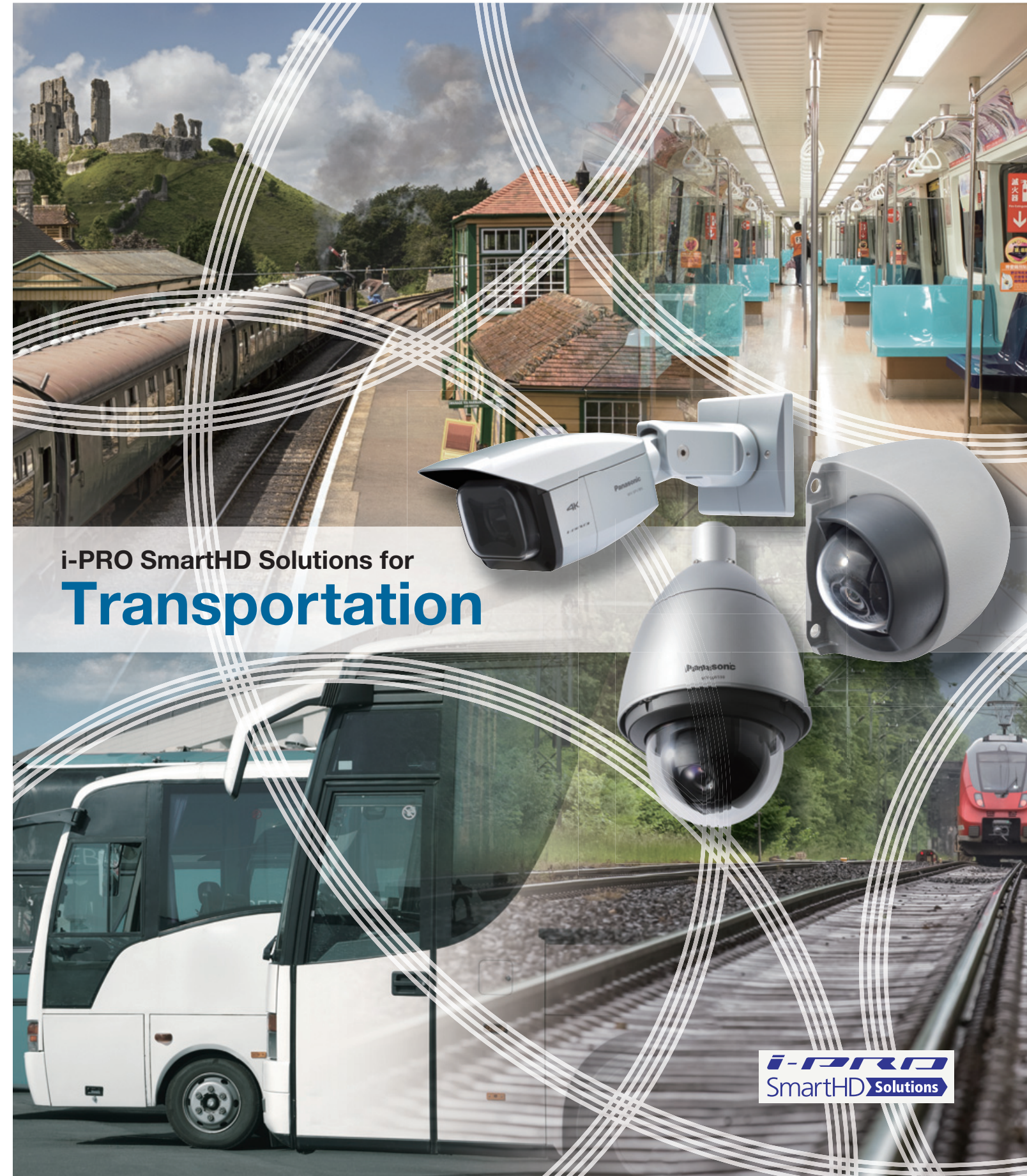

i-PRO SmartHD Solutions for
Transportation

i-PRO
SmartHD Solutions

What are the current problems?

Station / Station Square



Unable to see the required parts (face and number plates, etc.) because of an analog system

Cameras unable to adjust to changes in the surrounding environment

Limitations to crime prevention due to camera blind spots

Wanting to utilize existing analog systems for IP migration

Track and Railway



Preventing intruders on the tracks and pranks such as rocks placed on the railway tracks

Inability to see due to mist, strong rain, or snow

Wanting to reduce maintenance and equipment costs

Needing to respond to seasonal changes in the environment, such as high and low temperatures

Areas become completely dark (0 lux) at night due to a lack of streetlamps

Control Room



A large number of security cameras required to monitor a wide area

Captured images cannot be clearly seen due to bad weather

Suspicious persons such as terrorists cannot be searched for even if images of their face exist

A long time is taken to search for the required images

No way to check video when away from the control room

Train / Bus



Many blind spots result in vandalism and molestation

Possibility of damage and blocking of cameras installed in low areas

Capturing video of accidents outside the vehicle with a tough camera that can withstand high temperatures, and damage from car wash equipment, etc.

Panasonic systems solve all of these problems and provide you with solutions to suit your needs

- Capture the desired images clearly and without fail
- Intelligent cameras quickly detect and notify you of abnormal situations
- Environment resistance and a wide product lineup for use in various environments and scenarios
- One-stop provision of management software, controllers, and recorders, etc., in addition to cameras
- Migrate to advanced IP systems while utilizing existing analog systems and cables, etc.

Solutions we offer you and their benefits

Compact size Dome & Rugged mobile Network Camera

WV-SW158,
WV-SW155/155MA
WV-SBV131M/111M



Weather Resistant Network Camera

WV-SPV781L
WV-SPW631L



Control Room

Network Video Recorder

WJ-ND400, WJ-NV300



i-PRO Management Software

WV-ASM200, WV-ASC970/ASM970



Face Recognition System

WV-ASF900



Vandal resistant Dome Network Camera

WV-SFV781L
WV-SFV631L
WV-SFV611L



PTZ Indoor Dome Network Camera

WV-SC588



PTZ Weather resistant Network Camera

WV-SW598
WV-SW397A



360-degree Dome Network Camera

WV-SFV481
WV-SW458/458MA



Indoor Box type Network Camera

WV-SPN31 1A (For Facial Recognition)



360-degree Dome Network Camera (4K Engine)

WV-SFV481
WV-SFN480

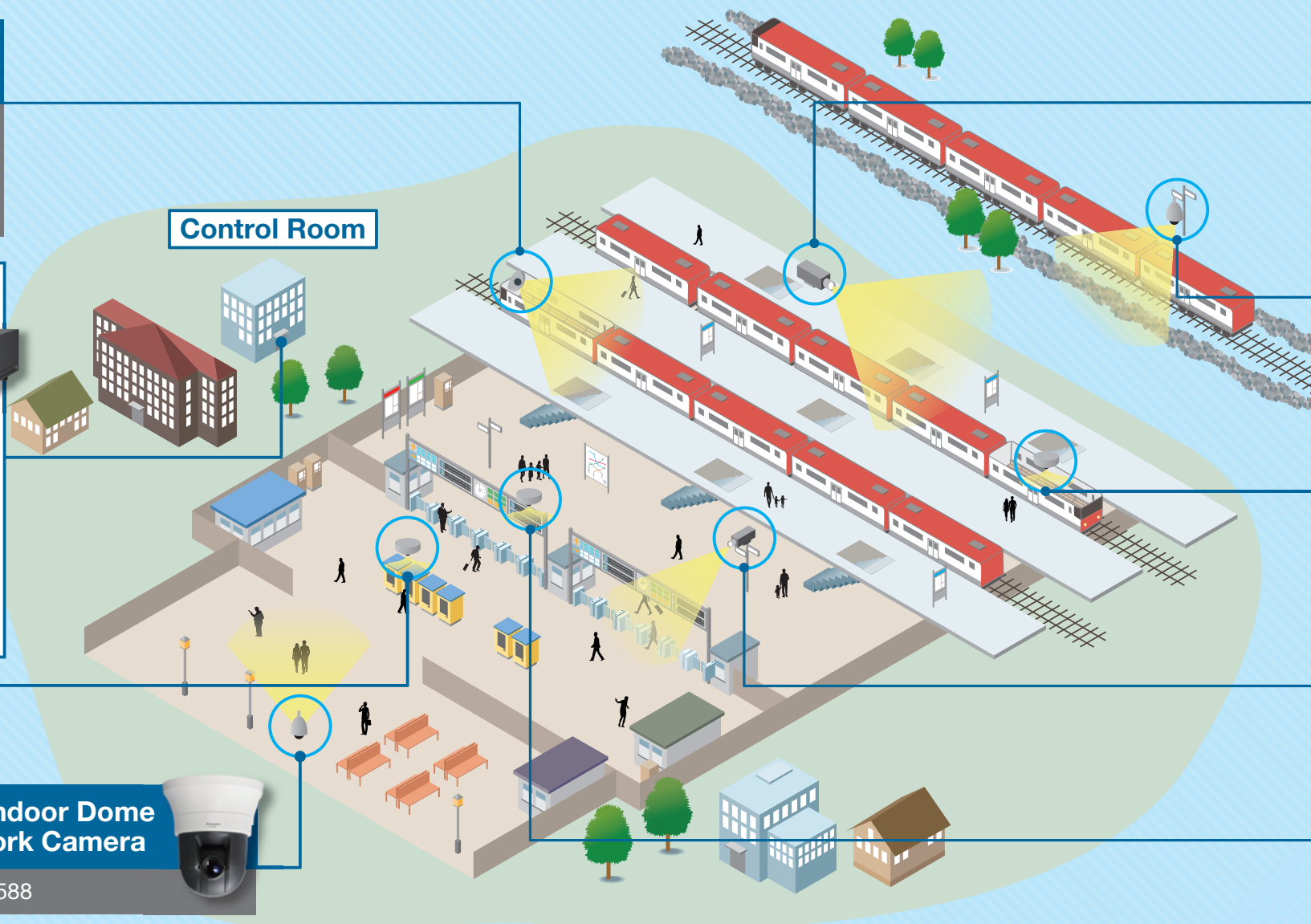

Station / Station Square

High image quality and high resolution exceeding 4K provides smooth video

High visibility in environments with low illumination and capturing of indoor and outdoor locations at the same time

Realize monitoring systems without blind spots using wide angle cameras and the preset functions

Construct systems that effectively utilize existing analog equipment

Track and Railway

Cameras use image recognition technology to detect intruders and immediately notify a control center

Realtime removal of factors that hinder sight, such as mist, heavy rain, and snow

Rain wash coating (clear sight coating) for maintenance-free operation

Varied range of products and the durability required to handle various environments

IR LEDs enable the detection of intruders even in pitch black environments

Control Room

Cameras dynamically notify you of changes without human monitoring

Enable post analysis by using visibility enhancement technology for recorded data

Search for and detect suspicious persons with registered face information, even across multiple cameras

Timeline view for immediate searching of required images

Monitor from tablets and smartphones with an optimal sized image

Train / Bus

Wide-angle and low-distortion cameras

Vandal resistant mechanisms and intelligent functions such as scene change detection

Support for outside installation without any housing or shrouds to protect from car wash equipment and tree branches

Compatible with EN50155-T3, EN50121, ECE-R10, EN45545, EN50498 "Railway applications" and EN45545 "Fire safety on rolling stock"

Station / Station Square

High Image Quality

Providing Smooth Images with High Image Quality Exceeding 4K

Panasonic network cameras use the newly developed LSI platform and highly sensitive MOS sensors to provide video with high image quality and smooth and natural color tones. Clear and easy to view images of the location you want to monitor can be provided in various locations, both indoors and outdoors. The maximum resolution is 4,000 x 3,000 pixels (WV-SFV781L / WV-SPV781L). A frame rate of 60 fps at 2,048 x 1,536 pixels can be captured to support locations where fast cars and trains pass by. JPEG/H.264 multiple streaming transmission is also supported.



High-Precision and Wide Range Monitoring

A single 4K resolution camera covers a wide area. High quality images enable far away objects to be checked.



Super Dynamic Technology

In stations and on railway tracks, subjects can become backlit or partially hidden in shadow due to the direction of sunlight changing according to the season and time of the day, which can cause images to become hard to see. In images with a large difference in illumination, bright areas become too white and dark areas become hard to see. However, Super Dynamic technology adjusts the dark areas and bright areas to enable monitoring with natural images. This can be particularly useful for identifying individuals by brightening human faces in environments where light is shining from behind the subject.



PTZ Camera for Wide Range Monitoring and a High Zoom Ratio

Normal fixed lens cameras can only monitor a certain direction, but the lens of a PTZ camera can be operated remotely to switch to the direction you want to view. Detailed areas can also be zoomed in to a maximum of 90x. Since the cameras can be infinitely rotated 360 degrees at a high speed of 300 degrees/sec, you will not miss the subjects you want to monitor.

- Advanced Auto Tracking

When suspicious movements are discovered in the video, the camera can lock on to that person to perform automatic tracking using the pan, tilt, and zoom functions. A wide range can be covered by endless 360 degree horizontal rotation and 210 degree vertical rotation, and situations can be monitored in detail with a maximum of 90x zoom (30x optical zoom and 3x extra zoom). Even if another person passes by the person who is being tracked, tracking can continue.



Day / Night Function

The day/night function automatically switches the camera from color to B/W and vice versa depending on the illumination, which is ideal for 24-hour surveillance. With moving IR cut filter and ABF (Auto Back Focus), both high sensitivity and accurate focus are ensured.

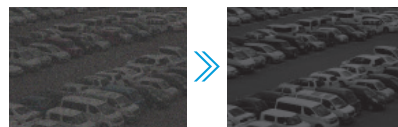

Support for Various Installation Environments

Waterproof and Dustproof

Waterproofing and dustproofing function compliant with IP66. Can be installed outside in an area that receives direct wind and rain without special housing. Compliant with IP66 (IEC60529)

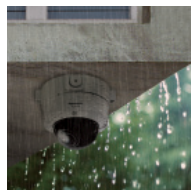

Dehumidifier

The camera is equipped with a dehumidifier that keeps the internal moisture level low, preventing condensation and quickly dissipating any condensation that forms. Even when a camera is installed in a location subject to greatly varying temperatures, the dome cover prevents the monitored image from being obstructed by fogging.

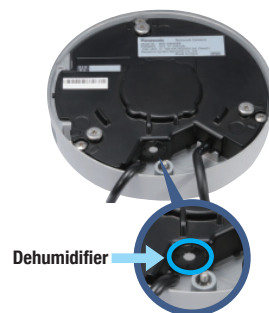

Intelligent Functions

Intelligent VMD

Intelligent functions to make your security system operations easier and more secure

Intruder Detection



Detects
- the motion of objects in the shooting or detection area. Frames and tracks are displayed around the detected moving object in the live image. Up to 8 objects can be detected simultaneously.

Loitering Detection

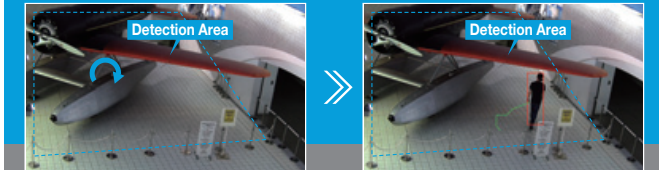

Detects
- objects loitering for longer than a specified time from 10 sec to 5 min.

Direction Detection



Detects
- objects moving in a specified direction. Up to 8 directions can be specified.

Scene Change Detection



Detects
- interference caused by tampering with the camera, such as a manual change in the camera direction or blockage of the lens with cloth or spray paint.

Object Detection



Detects
- alerts the operator that a left or removed object is detected.

Cross Line Detection

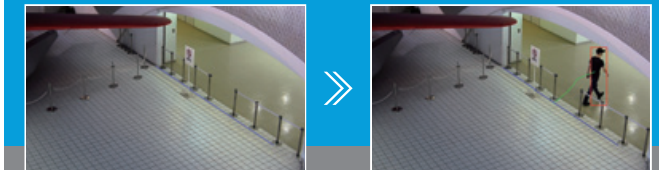

Detects
- alerts the operator that people or objects cross the imaginary lines.

Complete with powerful intelligent functions (WV-SFV481/WV-SPN480 Only: Optional)

Heat-map

This provides visualization of the traffic patterns by people and how long they stay in one place. For example, you can place products based on how people tend to flow within the store and arrange objects so that they do not interfere with the movement of people.

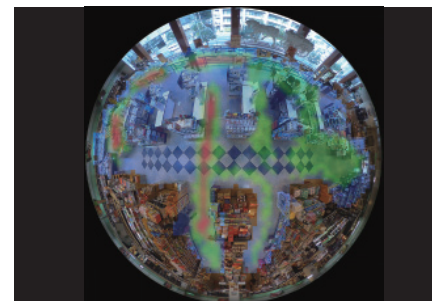

People Counting

This counts the number of people passing through a selected preset location. The People Counting function can provide statistics on the number of people entering and leaving a specific zone and other useful data.

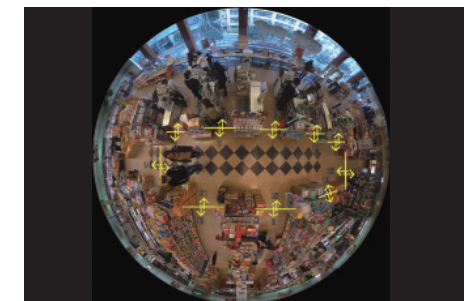

IR LED to Support 0 Lux Environments

Cameras with an IR LED can be used to monitor environments that are completely dark. This enables locations without the level of illumination required to capture images to be monitored to prevent graffiti, illegal dumping, and property destruction. The IR LED can illuminate a wide area so that monitoring is not limited to a specific part of the area.



Fog and Smoke Reduction

Video can be corrected to provide clearer images by removing elements that obstruct the camera's field of vision, such as fog or sandstorms.



High Light Compensation

If a bright light source such as car headlights points in the direction of a camera, the area around the light source becomes white and cannot be seen. Panasonic cameras correct for strong lights and their surroundings to provide clear images of areas that could not be seen with other cameras.



Wide Ambient Operation Temperature

Installation in various places is possible since a wide ambient temperature is supported. The integrated structure of the camera includes a sun shield and a heater for cold weather regions, allowing it to be used in a variety of locations where the ambient temperature ranges from $-50^{\circ}\text{C}^{\ast 1}$ to 55°C . Stable camera operation is possible even in extreme environments.

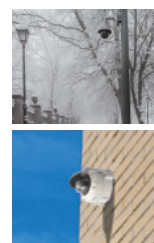

^{\ast 1} When using a PoE Injector

Vandal Resistant Mechanism

Extremely shock-proof – will not break even under strong impact. Vandalism-proof cameras can be used without concern, even when they must be installed in locations that can be reached by people.

Compliant with 50J (IEC 60068-2-75) / IK10 (IEC 62262)
Proved to withstand tests where a 5 kg weight is dropped onto the dome from a height of 1 m.



Rain-wash Coating

The application of rain-wash coating to the dome cover provides clearer visibility, allowing good security to be maintained even when the camera is installed in an environment subject to rain or water splashing. In addition, the coating resists attachment of dirt to the dome cover, and also allows dirt to be washed off easily during rainfall or other exposure to water.

^{\ast} WV-SFV781L / WV-SPV781L / WV-SW598 / WV-SW397A

Coated areas are resistant to water droplets



Non-coated

Coated areas are resistant to dirt



Non-coated

Rain-wash coated

^{\ast} Supported functions and specifications differ according to the model. See the specifications for each model.

Management Software

Software for performing batch management can also be selected according to the scale of the system. This software can be used to efficiently and effectively operate systems using the minimum required resources, reducing TCO.

For large scale systems

IP Matrix Server Software WV-ASC970/WV-ASM970
A large scale system that uses a combination of a Linux server and Windows PCs. Enables environments with both IP and analog devices to be managed and operated.

System Example

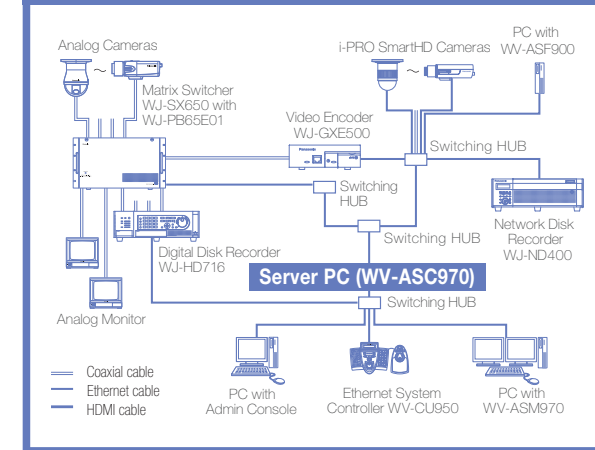

Facial Recognition Analytics Platform

Facial Recognition Analytics Platform realizes following function

Face matching

By registering specific faces in advance, the camera can automatically detect when those faces appear in the image, and sound alarms. This enables you to register information for terrorists and suspicious people, and sound alarms when those faces appear in stations or railway facilities.



Face search

Images of faces can be used to search for movements of that person. Multiple cameras can also be used to search where and when that person was on a timeline. When suspicious people are detected, you can check their movements at specific times, including whether they have been, and what route they took.



People Counting, Age and Gender Statistics

The number of people that pass by a camera can be counted, and their age and gender determined for output in statistic data. This enables you to output statistics to check how many people pass through each area, whether there are more males or females, and the age group of the people. This data can be used for effectively constructing traffic routes inside and around stations, and as a marketing tool such as when shops display products inside stations.



Visibility Enhancement

Even in situations where bad weather such as snow or heavy rain means that the video cannot be seen well, i-PRO Management Software (WV-ASM200+WV-ASE205 or WV-ASM970+WV-ASE903) can be used to correct live images and images that have been recorded. It is also possible to brighten dark subjects to make areas that are hard to see more visible.



360-degree monitoring, recording and de-warping

A 360-degree camera can be used to monitor and record wide areas such as station ticket gates, halls, and station plazas without blind spots. However when the fisheye images are played back at the control room, it is extremely difficult to check the status and movements of specific areas. i-PRO Management Software WV-ASM200+Extension Software can be used to cut out areas from the fisheye images and convert them into a format that can be easily checked. This de-warping technology achieves both monitoring without blind spots and easy to view images.



Recorded images

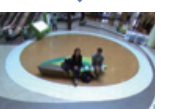

Reproduced image (The cut easy to see the specific area)

Mobile Monitoring

Even when you are in a control room, you can access a camera from a smartphone or tablet to check the status. If you access the recorder, you can play back recorded data in addition to viewing live images. Panasonic provides iOS and Android apps free of charge.



• Download the Panasonic Security Viewer application on the Google play™ store, Apple App Store.

Android™ <http://security.panasonic.com/pss/security/psv/android/index.html>

iPhone/iPad <http://security.panasonic.com/pss/security/psv/ios/index.html>

To use the application Via the Internet

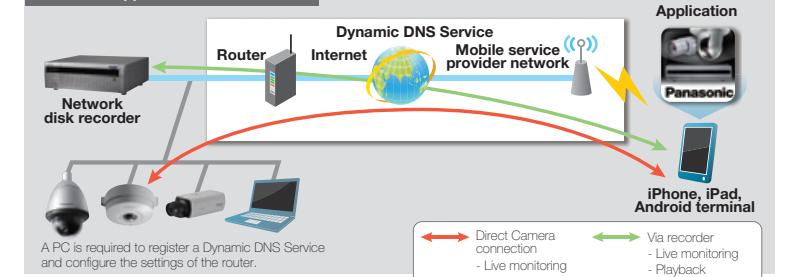

Mobile Playback

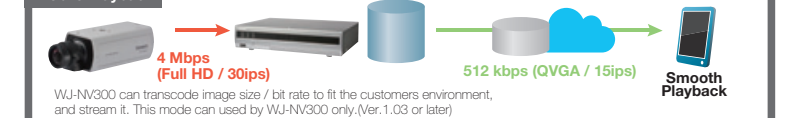

Train / Bus

In Trains



180-degree Panorama mode

Wide Coverage without Blind Spots

The application of rain-wash coating to the dome cover provides clearer visibility, allowing good security to be maintained even when the camera is installed in an environment subject to rain or water splashing. In addition, the coating resists attachment of dirt to the dome cover, and also allows dirt to be washed off easily during rainfall or other exposure to water.

Compatible with EN50155 "Railway applications" and EN45545 "Fire safety on rolling stock"

EN50155 "Railway applications" :
Electronic equipment used on rolling stock
EN45545 "Fire safety on rolling stock" :
Preventive fire protection in railway vehicles - Fire behavior and fire side effects of materials and parts.

Recommended Mobile Recorders for Train (Wireless Camera Recording Unit WCRU-III)*

- Rugged IP54 grading
- Support up to 8 Cameras
- Support fast seamless roaming
- Built-in accelerometer



*This is a product from RFNet Technologies Pte Ltd. Contact a sales representative to purchase it.

360-degree Dome Network Camera

WV-SFV481

- 360° monitoring with a wide variety of transmission modes: Panorama, Double Panorama, Quad PTZ, Single PTZ, and Quad streams (H.264/VGA)
- 9 mega (2,992x2,992) pixel images up to 15 fps by new 4K ULTRA HD engine.
- Compatible with EN50155 "Railway applications" and EN45545 "Fire safety on rolling stock".
- Low profile design for discrete installation
- Vandal resistant mechanism for high reliability
- IP66 rated water and dust resistant. Compatible with IEC60529 measurement standard, Type 4X (UL50), NEMA 4X compliant.



In Buses

Bus Solution

Our NEW i-PRO Transit solution equips transit agencies with the tools to provide a safer environment for bus passengers and drivers while protecting the vehicles from theft and vandalism and reducing expensive manpower requirements to manually upload video data. The system provides complete video surveillance of the inside and outside of the bus— improving response times to incidents as well as increasing the chances of arrest and conviction should a crime occur, helping reduce time spent in litigation.

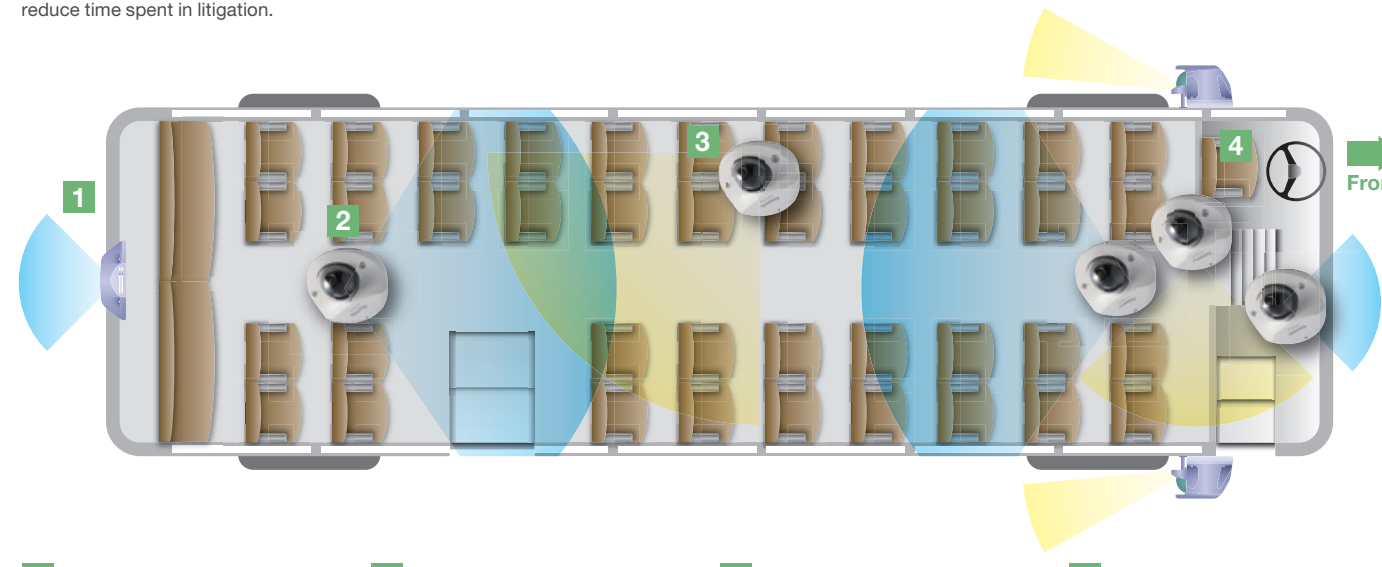

Recommended Mobile Recorder for Bus (VTC7110)*

Bring unrivaled computing power and exceptional video graphics handling onto the bus with this rugged, mobile-ready recorder. With its ability to record and wirelessly transmit HD video from up to four IP cameras (up to 16 with an optional expansion switch), transit control rooms can be given complete situational awareness of the vehicle in real time.

*This is a product from NEXCOM International Co., Ltd. Contact a sales representative to purchase it.



Compact Size Dome Network Camera

WV-SW155MA

- 720p HD images up to 30 fps
- 1.3 Megapixel high sensitivity MOS Sensor
- Wide coverage (Horizontal: 104°, Vertical: 85°)
- Compatible with EN50155 "Railway applications" and EN45545 "Fire safety on rolling stock".
- Low profile design for discrete installation
- Vandal resistant mechanism for high reliability
- IP66 rated water and dust resistant. Compatible with IEC60529 measurement standard, Type 4X(UL50), NEMA 4X compliant.



Rugged Mobile Network Camera

WV-SBV131M / WV-SBV111M

- 1080p Full HD images(WV-SBV131M) , 720p HD images (WV-SBV111M) up to 30 fps
- The camera conforms to the IP66, Type 4X (UL50) and IP6K9K, is compliant with NEMA 4X ratings, and provides high dust resistance and waterproof performance.
- Achieves high-level vibration resistance with EN50155 and MIL-STD-810G compliance
- Adoption of a scratch resistant dome cover with a compact and sleek design is optimal for cameras installed on the outside of a vehicle.
- Vandal resistant mechanism for high reliability



Launches in December 2015

* Supported functions and specifications differ according to the model. See the specifications for each model.

Panasonic Security Product Lineup for Ensuring Safety

Lineup

PTZ Network Cameras (Outdoor model)



PTZ Network Camera (Indoor model)



Dome Network Cameras



Box type Fixed Network Camera

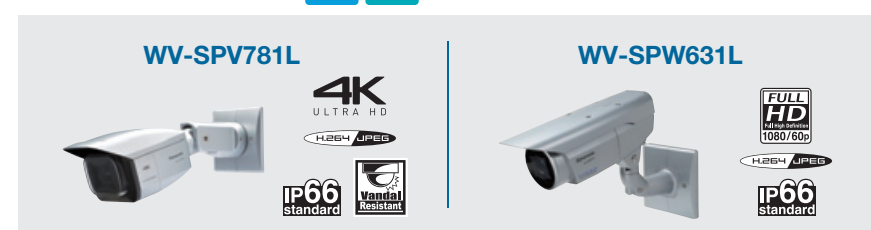

Indoor Box type Network Cameras



360-degree Dome Network Cameras (4K Engine)



360-degree Dome Network Cameras



Compact size Dome Network Cameras

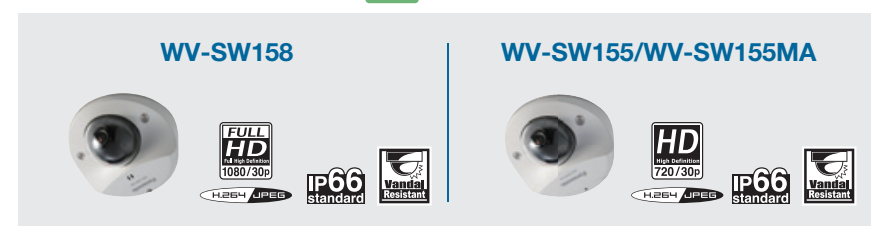

Rugged Mobile Network Camera



Launches in December 2015

ONVIF All the above models support Onvif.



* The above models are only part of the lineup. See the following URL for the entire lineup. <http://security.panasonic.com>

Network Video Recorders

WJ-ND400

High performance network disk recorder for megapixel i-PRO network cameras with 9 serial ATA HDD slots

- Up to 64 network cameras can be connected without an extra license fee and their images can be recorded simultaneously.
- Various recording modes: Manual, Schedule including Event (Pre/Post), Emergency. The schedule mode includes eight recording programs with an individual recording mode for each camera, and 6 time schedules per day.

WJ-NV300

32ch network disk recorder with built-in video decoder

- Quick setup with automatic camera detection and a simple setup wizard without the use of a PC.
- Supports two full HD outputs (HDMI) that can display recorded images and live images in high definition.

WJ-NVF30 / WJ-NVF20

Additional Business Intelligence Kit for WJ-NV300 / WJ-NV200

- New statistical processing functions such as "people counting" and "face matching / age & gender judgment"

Recommended Mobile Recorders



Coaxial-LAN Converter

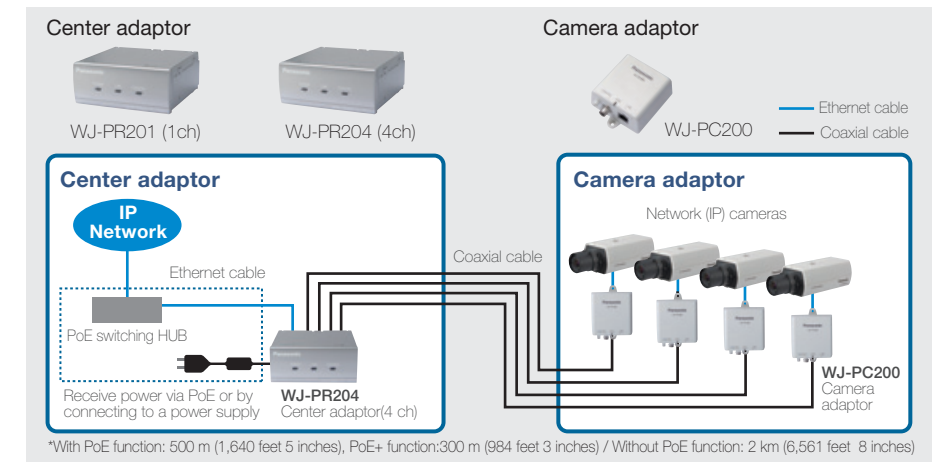

Table of supported functions

	WV-SFV781L	WV-SW598	WV-SW397A	WV-SC588	WV-SFV631L	WV-SFV611L	WV-SFV481	WV-SFN480	WV-SW458(WV-SW458MA)	WV-SW158	WV-SW155(WV-SW155MA)	WV-SFV781L	WV-SFV631L	WV-SPN311A	WV-SBV131M/WV-SBV111M
Outdoor / Indoor	Outdoor	Outdoor	Outdoor	Indoor	Outdoor	Outdoor	Outdoor	Indoor	Outdoor	Outdoor	Outdoor	Outdoor	Outdoor	Indoor	Outdoor
Super Dynamic	-	MEGA SD	MEGA SD	MEGA SD	Enhanced SD	Enhanced SD	-	-	MEGA SD	MEGA SD	MEGA SD	-	MEGA SD	Enhanced SD	-
Fog and Smoke Reduction	✓	✓	✓	✓	✓	✓	-	-	-	-	-	✓	✓	✓	✓
High Light Compensation	✓	✓	✓	✓	✓	✓	-	-	-	-	-	✓	✓	✓	✓
Pan	-	360°endless	360°endless	360°endless	-	-	-	-	-	-	-	-	-	✓	-
Tilt	-	-15° - 195° (w/Trt Flip)	-15° - 195° (w/Trt Flip)	-25° - 205° (w/Trt Flip)	-	-	-	-	-	-	-	-	-	✓	-
Zoom	6x optical 4x digital	30x optical 12x digital	45x extra-optical 12x digital	30x optical 12x digital	3.6x optical 4x digital	3.6x optical 4x digital	4x digital	4x digital	4x digital	4x digital	4x digital	6x optical 4x digital	3.6x optical 4x digital	Lens: optional	3x digital
Auto Tracking	-	Advanced AutoTracking	Advanced AutoTracking	Advanced AutoTracking	-	-	-	-	-	-	-	-	-	-	-
Dehumidifier	✓	✓	✓	-	✓	✓	✓	✓	✓	✓	✓	✓	✓	✓	-
Rain-wash Coating	✓	✓	✓	✓	✓	✓	✓	✓	✓	✓	✓	✓	✓	✓	-
Operating Temperature	-45 °C to +50 °C	-50°C to +55°C*1 [24 VAC, PoE+] -30°C to +55°C*1	-50°C to +55°C*1 [24 VAC, PoE+] -30°C to +55°C*1	-100°C to +55°C*	-45 °C to +50°C*	-45 °C to +50°C*	-40 °C to +50 °C	-10 °C to +50 °C*	-40 °C to +50 °C*	-30 °C to +50 °C*	-30 °C to +50 °C*	-45 °C to +50 °C*	-40 °C to +50 °C*	-10 °C to +50 °C*	-40 °C to +60 °C*
Day/Night Function	ICR	ICR*1	ICR	ICR*1	ICR*1	ICR*1	ICR*1	Electrical	ICR*1	ICR*1	ICR*1	ICR	ICR*1	ICR	Electrical
IR LED	✓	-	-	-	✓	✓	-	-	-	-	-	✓	-	Optional	-
Intelligent VMD	-	-	-	-	Optional	Optional	-	-	-	-	-	-	-	Optional	-
Railway Application	-	-	-	-	-	-	ENS0155, ENS0121	-	ENS0155, ENS0121	ENS0155, ENS0121	ENS0155, ENS0121	-	-	-	ENS0155, ENS0121

*1 With PoE Injector (60W)
*2 ICR: Infrared cut filter equipped

One-stop System Construction Including Cameras, Recorders, and Integrated Management Software

Lineup

Face Recognition System

WV-ASF900 Series

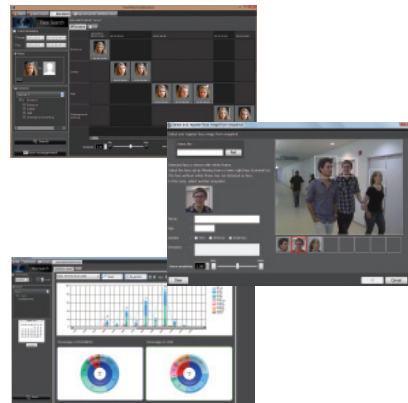

- Add-on face matching function: Simply add the necessary devices and software to enable a face matching function.
- Can be connected up to 20 cameras on a server.

- Face Search

- Face images that the camera has detected are stored and can be searched later.
- By searching the face database, you can display the result of each camera in chronological order and find the movement locus of persons.
- Specify a camera or date for detected face images and display the results in the list in similarity order.

- Face Matching

- When a match is found with a registered person, a real-time alert is output and displayed in the alert history
- Specified screen images can be played back on a control monitor by double-clicking an alert in the history.

- People Counting, Age and Gender Statistics

- Count detected people and evaluate their age and gender
- Display the results on the screen with a statistical graph
- The statistical data can be saved as a CSV file for analytical use.

i-PRO Management Software

WV-ASM200 Series



i-PRO management software for multi-recorder multi-site systems

- Integrated control of multi-recorder, multi-site systems.
- Ideal solution for a wide range of applications to maximize the advantage of an i-PRO SmartHD Network Surveillance System.

Extension Software

- WV-ASE201: Supports multi-monitor displays, Ethernet system controller (WV-CU950)
- WV-ASE202: Max. 64 split-screen display
- WV-ASE203: Expands the number of recorders that can be connected
- WV-ASE204: Expands the number of decoders that can be connected
- WV-ASE205: Visibility enhancement
- WV-ASE231: Link to a face searching server (WV-ASF900)

Ethernet System Controller

WV-CU950 *WV-ASE201 is necessary



WV-ASC970/ASM970 Series



IP Matrix Server Software

- Flexible system design: Analog, IP, and hybrid analog/IP
- Multi-monitor option enables simultaneous use of operation screen and monitor screen (1 / 4 / 7 / 9 / 10 / 13 / 16 split) on a dedicated monitor. Two monitor operation is also available. Support 100 maps.

Extension Software

- WV-ASE901*: Link to a fire alarm system
- WV-ASE231: Link to a face searching server (WV-ASF900)
- WV-ASE903: Visibility enhancement

* WV-ASE901 is only sold in certain areas. Please contact the sales company for details.

Ethernet System Controller

WV-CU950



Panasonic Security Systems in Use Around the World

Case Study

Denver RTD Bus Transit System, USA

- Background

Seeking to maintain safety and security, replace their aging analog-based system and reduce the manpower spent manually uploading video data, the Denver Regional Transportation District (RTD) Transit Police Division installed Panasonic's new i-PRO Transit solution across its bus fleet. The solution includes durable Full HD 1080p and HD 720p network cameras inside and outside of each bus, integrated with other hardware and software components for recording, file transfer, viewing and management.

- System Adoption Method and Effects

The Panasonic i-PRO Transit solution significantly enhances the RTD's investigative efficiency by automatically offloading video recordings and integrating them with various other video and audio sources to create a unified event timeline.

Panasonic's market-leading i-PRO network cameras form the foundation of the solution. With HD 1080p (WV-SW158) and HD 720p (WV-SW155M) network cameras inside and outside of each bus, integrated with other hardware and software components for recording, file transfer, viewing and management, the system delivers an end-to-end mobile security solution for the growing transportation agency. Delivering improved video quality and clarity as well as wider fields of view, the cameras are also designed for use in a transit environment, and are engineered to withstand shocks and impacts as well as being IP66-rated water and dust resistant. Additionally, the in-vehicle recorders are equipped with anti-vibration mounts to ensure long-term performance, and cameras on bus exteriors are secured in shroud housings for added protection.

A key benefit of the solution is the ability for RTD staff to quickly and wirelessly offload flagged video files associated with specific incidents from the buses' in-vehicle recorders. This eliminates the need to manually offload data and search through files when investigating an incident, saving the agency significant time and costs.

- Customer Comment

With our former analog-based system, RTD Security had to physically retrieve hard drives from buses to investigate incidents an average of 25-30 times per day – a significant waste of time and resources. Video quality was also poor and sometimes unusable. Working with Panasonic, we developed a high-quality solution from the ground up to address these issues and more importantly, to ensure the security of our bus system for our 101 million passenger trips a year.

Bob Grado
Denver RTD Transit Police commander and manager of integrated security operations



Murcia Tram Security System, Spain

- Background

For reasons of information and security, Murcia Tram installed a Panasonic security solution across all their infrastructure including stations. The solution includes i-PRO fixed and PTZ cameras plus an IP matrix system. The IP matrix is integrated in the security and information control center with the rest of the telecommunications systems including communications, timing, traveler information, intercoms, access control, ticketing, telephony, operations, and Tetra radio, allowing effective and easy management of live and recorded images.

- System Adoption Method and Effects

The Panasonic security system with the WV-ASM970 IP matrix ensures the comfort and safety of all Murcia Tram passengers.

Thanks to the i-PRO fixed and PTZ HD 720p cameras installed in different tram stations, images in HD quality can be viewed to ensure the smallest details, to guarantee the safety of passengers and pedestrians and prevent incidents in railway structures and traffic light crossings.

From the control center and with the WV-ASM970 IP matrix management software, all images are viewed and recorded for prevention, and in case of any incident, the easy operation of the system optimizes the time and resources of the investigation.

- Customer Comment

The Panasonic security solution has been proven to be an efficient and reliable system for Murcia Tram and our monitoring staff emphasize its friendly interface.

Santiago Molina Onate
Technical Director
Sociedad Concesionaria Tranvía de Murcia

