

Zoom Lens

Description

This zoom lens is designed for use with a Panasonic's applicable projector. The lens makes it possible to vary the projection distance by changing the focal distance.

*Please use the lens only on the specified Panasonic projectors.

Specifications (Specifications are subject to change without notice.)

F value		1.8 ~ 2.3
Focal distance (f)		45.6 mm ~ 73.8 mm
Throw ratio		WUXGA 2.8 – 4.6:1 for PT-MZ770/MZ670/MZ570/EZ770Z (16:10 aspect ratio) WXGA 2.8 – 4.6:1 for PT-MW730/MW630/MW530/EW730Z (16:10 aspect ratio) XGA 2.8 – 4.6:1 for PT-EX800Z (4:3 aspect ratio)
Dimensions	Width	108 mm [4-1/4 inch]
	Height	108 mm [4-1/4 inch]
	Depth	197 mm [7-3/4 inch] (at maximum length)
Weight		Approx. 1.18* kg (2.6* lbs)
Applicable projector		[GROUP A] PT-EZ770Z series : PT-EZ770Z/EZ770ZL/EW730Z/EW730ZL/EX800Z/EX800ZL [GROUP B] PT-MZ670 series : PT-MZ670/MZ670L/MZ570/MZ570L/MW630/MW630L/MW530/MW530L PT-MZ770 series : PT-MZ770/MZ770L/MW730/MW730L PT-MZ880 series : PT-MZ880/MZ780/MZ680 For these projectors see the individual spec files of the projectors.

* Average value. May dif fer depending on the actual unit.

Dimensions

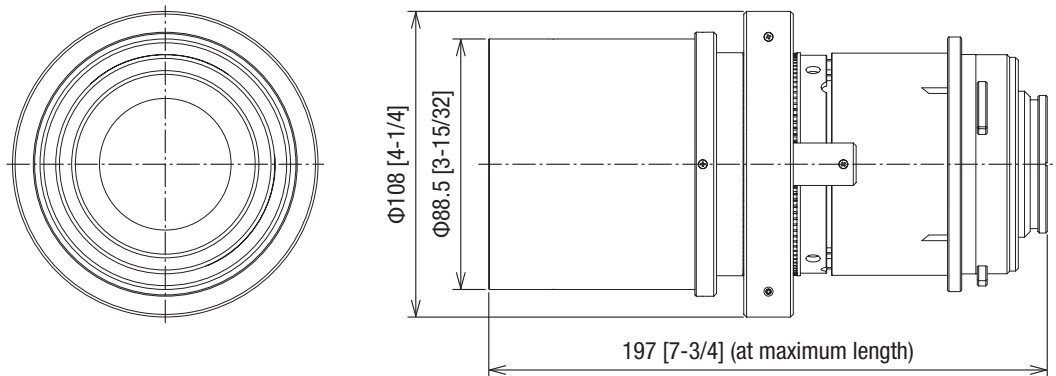

unit : mm [inch]
This illustration is not drawn to scale.

Zoom Lens

The illustration shows the lens attached to the projector.

[GROUP A]

PT-EZ770Z series : PT-EZ770Z/EZ770ZL/EW730Z/EW730ZL/EX800Z/EX800ZL

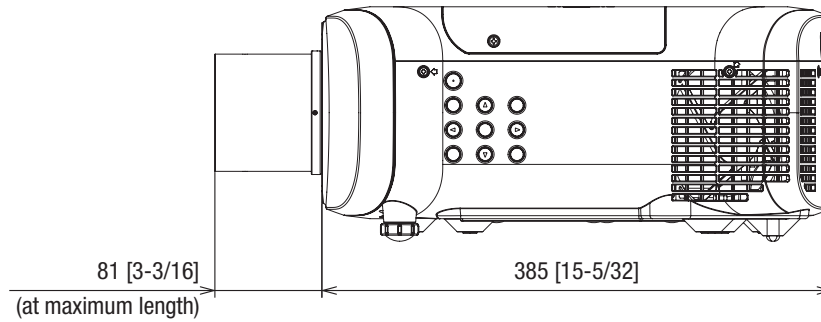

[GROUP B]

PT-MZ670 series : PT-MZ670/MZ670L/MZ570/MZ570L/MW630/MW630L/MW530/MW530L

PT-MZ770 series : PT-MZ770/MZ770L/MW730/MW730L

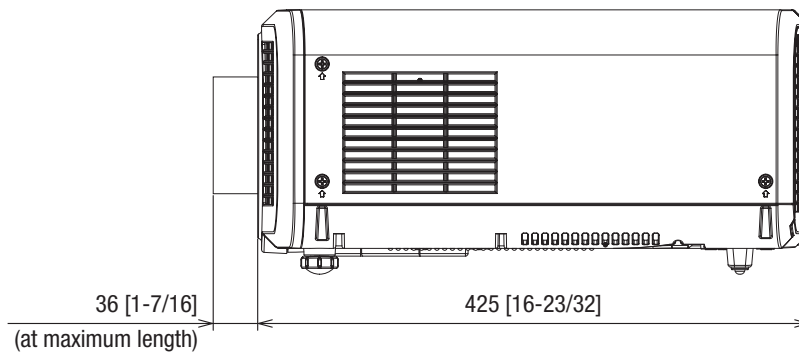

unit : mm [inch]
This illustration is not drawn to scale.

Note

- Please read the projector's instruction manual for throw distances.