

Panasonic[®]

Operating Instructions Functional Manual

FULL HD LCD Display

For business use

English

Model No. **TH-55LFV9U** 55-inch model

TH-55LFV9W 55-inch model



* The instructions in this manual apply to all models irrespective of the suffixes to the model number.

U: for US, Canada and Mexico

W: for EU, CIS, South East Asia and Middle East Asia

English

Please read these instructions before operating your Display and retain them for future reference.



HDMI[™]

DPQP1279ZC/X1

Dear Panasonic Customer

Welcome to the Panasonic customer family. We hope that you will have many years of service and enjoyment from your new LCD Display.

To obtain maximum benefit from your Display, please read these Instructions before making any adjustments, and hold on to them for future reference.

Keep your purchase receipt as well, and record the model and serial numbers of your set in the space provided on the rear cover.

Visit our Panasonic Web Site <https://panasonic.net/cns/prodisplays/>

Table of Contents

Before use

Pictures and images of screens in this manual are for illustration only and may be different from the actual physical device.

Important Safety Instructions	3
FCC STATEMENT	4
Important Safety Notice	5
Safety Precautions	6
Precautions for use	8
Accessories	10
Accessories Supply	10
Remote Control Batteries	11
VESA Mounting	11
Cautions when moving	12
Kensington security lock	12
Identifying Controls	13
Main unit	13
Interface	14
Remote Control	15
Connections	17
AC cord connection	17
Cable fixing	17
Before connecting	18
PC Input Terminals connection	18
VIDEO IN connection.....	19
COMPONENT connection	19
AUDIO OUT connection	20

Speaker connection	20
HDMI1, HDMI2 connection	20
DVI-D input / DVI-I output connection	21
DisplayPort input/output connection	22
SERIAL terminal connection	23
IR terminal connection	24
USB terminal connection	25
Connecting Multiple Displays in a Daisy-chain configuration	25
Basic controls	26
Watch the Connected Video Source	26
Change Picture Format	26
Choose your Preferred Picture Settings	26
Choose your Preferred Sound Settings.....	26
Play multimedia files from a USB device	26
Function controls	29
Picture	29
Sound	30
Tiling	30
General Settings	31
Network settings	34
Using the Network Function	34
The environment necessary for a computer connection	34
Example of network connection	35
Computer operation	35
PjLink protocol	35
Multi Monitoring & Control Software	38
USB device compatibility	39
Input Mode	42
Troubleshooting	44
Technical Specifications	46



WARNING: To reduce the risk of electric shock, do not remove the cover or back.

No user-serviceable parts inside. Refer servicing to qualified service personnel.



The label with lightning flash and arrow-head inside a triangle has been put there to warn the user that parts inside the product carry the risk of electric shock.



The label with exclamation point within a triangle is intended to inform the user that important operating and servicing instructions are in the documentation included with the unit.

WARNING:

To prevent damage which may result in fire or electric shock, do not expose this apparatus to rain or moisture.

Do not place containers with water, such as a flower vase, cups, cosmetics, above or near the unit, (including on shelves above.)

WARNING:

- 1) To prevent electric shock, do not remove the cover. No user serviceable parts inside. Refer servicing to qualified service personnel.
- 2) Do not remove the grounding pin on the power plug. This equipment is provided with a three pin grounded power plug. This plug will only fit a matching grounded power outlet. This is a safety feature. If you are unable to insert the plug into the outlet, contact an electrician.

Do not defeat the purpose of the grounded plug.

Important Safety Instructions

- 1) Read these instructions.
- 2) Keep these instructions.
- 3) Heed all warnings.
- 4) Follow all instructions.
- 5) Do not use this apparatus near water.
- 6) Clean only with a dry cloth.
- 7) Do not block any of the ventilation openings. Install in accordance with the manufacturer's instructions.
- 8) Do not install near any heat source such as a radiator, hob, or stove, or any other heat source (including amplifiers).
- 9) Do not defeat the safety purpose of the polarised, or grounded plug. A polarised plug has two blades, one wider than the other. A grounding plug has two blades and a third grounding prong. The wide blade or the third prong are provided for your safety. If the provided plug does not fit into your outlet, consult an electrician to have a suitable outlet installed.
- 10) Protect the power cord from being trodden on, or kinked or pinched, especially in the vicinity of the plug, wall socket, and point where it exits the equipment.
- 11) Only use attachments / accessories specified by the manufacturer.
- 12) Use only with the cart, stand, tripod, bracket, or table specified by the manufacturer, or sold with the unit. When a cart is used, use caution when moving the cart and unit to avoid injury that might result from it being tipped over. 
- 13) Unplug this unit during lightning storms or when it is to be out of use for a long time.
- 14) Refer all servicing to qualified service personnel. Servicing is required if the equipment has been damaged in any way, for instance if the power cord or plug has been damaged, liquid has been spilled or objects have fallen into the unit, or it has been exposed to rain or moisture, does not operate normally, or has been dropped.
- 15) To avoid electric shock, ensure the grounding pin on the AC power plug is securely connected.

FCC STATEMENT

This equipment has been tested and found to comply with the limits for a class A digital device, pursuant to Part 15 of the FCC Rules. These limits are designed to provide reasonable protection against harmful interference when the equipment is operated in a commercial environment. This equipment generates, uses and can radiate radio frequency energy and, if not installed and used in accordance with the instructions in the manual, may cause harmful interference to radio communications. Operation of this equipment in a residential area may cause harmful interference in which case the user will be required to correct the interference at their own expense.

FCC CAUTION:

To ensure continued compliance, follow the attached installation instructions and only use the provided power supply cord. Any changes or modifications not expressly approved by Panasonic Corp of North America could void the user's authority to operate this device.

Declaration of Verification

Model No.

TH-55LFV9U
TH-55LFV9W

Responsible Party:

Panasonic Corporation of North America
Two Riverfront Plaza, Newark, New Jersey
07102-5490

Contact Source:

Panasonic Connect North America
1-877-655-2357

General Contact:

<http://shop.panasonic.com/support>

This device complies with Part 15 of the FCC Rules and all applicable IC RSS standards. Operation is subject to the following two conditions: (1) This device may not cause harmful interference, and (2) this device must accept any interference received, including interference that may cause undesired operation.

CANADIAN NOTICE:

This Class A digital apparatus complies with Canadian ICES-003.

WARNING:

- Not for use in a computer room as defined in the Standard for the Protection of Electronic Computer/ Data Processing Equipment, ANSI/NFPA 75.
- For permanently connected equipment, a readily accessible disconnect device shall be incorporated in the building installation wiring.
- For pluggable equipment, the socket outlet must be near the equipment and easily accessible.

Note:

Image retention may occur. If a still picture is displayed for an extended period, the image might remain on the screen. However, it will disappear after a normal moving picture has been displayed for a while.

Trademark Credits

- PJLink is a registered or pending trademark in Japan, the United States, and other countries and regions.
- HDMI, the HDMI Logo, and High-Definition Multimedia Interface are trademarks or registered trademarks of HDMI Licensing LLC in the United States and other countries.

Even if no special notation has been made of company or product trademarks, these trademarks have been fully respected.

Important Safety Notice

WARNING

- 1) Guard against damage which might result in fire or shock and make sure there is no dripping or splashing in the vicinity.

Do not place containers of water, such as a flower vase, cups, cosmetics, etc near or above the display. (including on shelves above, etc.)

No naked flames, such as lighted candles, should be placed on or near the Display.

- 2) No user serviceable parts inside. Refer servicing to qualified service personnel.
- 3) Do not remove the earth pin on the power plug. This apparatus is equipped with a three pin earthed power plug. This plug will only fit a matched earthed power outlet. This is a safety feature. If you are unable to insert the plug into the outlet, contact an electrician.
Do not defeat the purpose of the earth pin.
- 4) To avoid electric shock, ensure the earth pin on the AC cord power plug is securely connected.

CAUTION

This appliance is intended for use in environments which are relatively free of electromagnetic interference.

Using this appliance near sources of strong electromagnetic field, or where electrical noise might overlap with the input signal, could cause the picture and sound to waver or cause interference and noise.

To avoid the possibility of harm to this appliance, keep it away from sources of strong electromagnetic field.

WARNING:

This equipment is compliant with Class A of EN55032/CISPR32. This equipment may cause radio interference in a residential environment.

IMPORTANT INFORMATION

If this display is not positioned in a sufficiently stable location, it may be likely to fall and present a potential hazard. Many injuries, particularly those to children, can be avoided by taking simple precautions such as:

- Using cabinets or stands recommended by the manufacturer.
- Only using furniture that can safely support the display.
- Ensuring that the display does not overhang the edge of supporting furniture.
- By not placing the display in a high place, such as on top of a cupboard or bookcase, without anchoring both the furniture and the display to a suitable support.
- Not placing the display where a table cloth or mat is between it and the supporting furniture.
- By teaching children about the dangers of climbing on furniture to reach the display or its controls.

IMPORTANT: THE MOULDED PLUG FOR YOUR OWN SAFETY, PLEASE READ THE

FOLLOWING TEXT CAREFULLY.

This display is supplied with a moulded three pin mains plug for your safety and convenience. This plug is fitted with a 10 amp fuse. Should the fuse need to be replaced, make sure the new fuse has a 10 amp rating and is approved by ASTA or BSI to BS1362.

Check the fuse for the ASTA  or the BSI mark .

If the fuse cover on the plug is removable, make sure that it is replaced after the fuse has been changed.

If you lose the fuse cover, do not use the plug until a new cover has been obtained.

A replacement fuse cover can be purchased from your local Panasonic dealer.

Do not cut the mains plug from the cable.

Do not use any other type of mains lead except the one supplied with the display.

The supplied mains lead and moulded plug are designed to be used with this display to avoid interference and for your safety.

If the AC socket outlet in your home is not suitable, get it changed by a qualified electrician.

If the plug, or mains lead itself, becomes damaged, purchase a replacement from an authorized dealer.

WARNING : — THIS DISPLAY MUST BE EARTHED.

How to replace the fuse.

Open the fuse compartment with a screwdriver and replace the fuse.

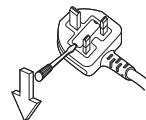

Safety Precautions

WARNING

■ Setup

Optional accessory

Securely install the Installation Mount of the optional accessories. Ask an authorized dealer for installation. 2 or more people are required for installation.

- Installation Mount
TY-VK55LV2
- Early Warning License (Multi Monitoring & Control Software)
Basic license / 3 years license (ET-SWA100 series *1)
- Video Wall Manager
TY-VUK10 *2

*1: The part number suffix may differ depending on the license type.

*2: Supports Ver 1.11 or later

Small parts may be accidentally swallowed by small children and are a choking hazard. Keep small parts away from young children. Discard unneeded small parts and other objects. This includes plastic bags and sheets which present a suffocation hazard for small children.

Do not place the Display on a sloping or unstable surface and make sure the base does not overhang an edge.

- The Display may fall off or tip over.

Install this display in a location with minimal vibration and which can support its weight.

- If the unit falls it may cause injury and certainly may result in malfunction.

Do not place any objects on top of the Display.

- If a foreign object or water gets inside the Display, a short-circuit may occur which could result in fire or electric shock. If any foreign object gets inside the Display, please consult your local Panasonic dealer.

Transport only in an upright position!

- Transporting the unit with its liquid crystal panel facing upwards or downwards may damage the internal circuitry.

Make sure the ventilation openings in the unit are not obstructed in any way, by curtains or other objects.

See page 8 for the requirements for sufficient ventilation.

Caution - For use only with UL Listed Wall Mount Bracket with minimum weight/load 27 kg (59.8 lbs).

When installing the Display vertically;

When installing the Display vertically, be sure that the Power Indicator is on the lower edge. Heat is generated and it may cause fire or damage to the Display.

The rotation direction is displayed on the rating plate and back cover of this unit. Confirm it during installation.

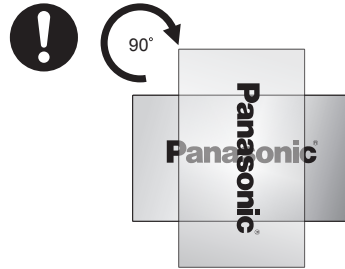

Cautions for Wall Installation

- Installation should be carried out by a professional. Installing the Display incorrectly may lead to an accident that results in serious injury or even death.
- When installation is to be made on a wall, a wall hanging bracket that conforms to VESA standards must be used.
VESA 400 mm × 400 mm
- Before installation, make sure the mounting location has enough strength to support the weight of the LCD display and the wall hanging bracket.
- If you decide to no longer use the Display on the wall, engage a professional to remove it as soon as possible.
- When mounting the Display on a wall, make sure the mounting screws and power cable do not make contact with any metal objects inside the wall. An electric short circuit or shock might be the result of contact with metal in the wall.

Do not place the display where it may be affected by salt or corrosive gas.

- Doing so may cause the display to fail due to corrosion. Also, the unit may malfunction.

Do not install the Display where it is exposed to direct sunlight.

- If the unit is exposed to direct sunlight even indoors, the temperature rise of the liquid crystal panel may cause malfunction.

■ When using the LCD Display

The Display is designed for 110 - 127 or 220 - 240 V AC, 50/60 Hz.

Do not cover the ventilation holes.

- Doing so may cause the Display to overheat. This may damage the display or even cause it to catch fire.

Do not stick any foreign objects into the Display.

- Do not insert any metal or flammable objects into the ventilation holes, or drop them on the Display. Doing so can cause fire or electric shock.

Do not remove the cover or modify it in any way.

- High voltage, which can cause severe electric shock, is present inside the Display. Please contact your local Panasonic dealer if any adjustment or repair work is needed.

Ensure that the mains plug is always easily accessible.

The mains plug must be connected to a mains socket outlet with a protective earthed connection.

Do not use a power supply cord other than that provided with this unit.

- Doing so may cause a short-circuit, generate heat, cause malfunction, electric shock, or even lead to fire.

Do not use the supplied power supply cord with any other devices.

- Doing so could cause electric shock or fire.

Insert the power supply plug firmly as far as it will go.

- If the plug is not fully inserted, heat may be generated which could cause fire. Do not use a power supply cable with a damaged plug or a loose wall socket.

Do not handle the power supply plug with wet hands.

- Doing so may cause electric shock.

Do not do anything that may damage the power cable. When disconnecting the power cable, pull the plug body, not the cable.

- Do not damage the cable, modify it, or place heavy objects on it. Do not allow the cable to contact any hot object, do not twist or bend it excessively, or pull it too hard. To do so may cause fire and electric shock. Have a damaged cable repaired or replaced by your local Panasonic dealer.

Do not touch a damaged cable or plug with your bare hands.

- Electric shock could occur.

Do not remove covers and NEVER attempt to modify the Display yourself.

- Do not remove the rear cover as live parts will become directly accessible. There are no user serviceable parts inside. (High-voltage components may cause serious electric shock.)
- Have the Display checked, adjusted, or repaired at your local Panasonic dealer.

Keep the AAA/R03/UM4 batteries (supplied) out of reach of children. Batteries are extremely harmful if swallowed.

- Get medical help immediately if you suspect your child may have swallowed a battery.

If the Display is not going to be used for a long time, disconnect it from the mains.

Picture noise may occur if you connect or disconnect the cables to input terminals you are not currently watching, or if you turn the power of the video equipment on or off. However, this is not a malfunction.

Keep all open flames such as candles away from this product at all times.



! CAUTION

In the event of problems or malfunction, stop using the display immediately.

■ In the event of problems disconnect the cable from the AC mains supply.

- Smoke or an abnormal odour emanates from the unit.
- Operation is intermittent, sometimes no picture appears or sound goes off.
- Liquid such as water or a foreign object has got inside the unit.
- The unit has failing or broken electronic components.

Continued use of the unit in this condition could result in fire or electric shock.

- Turn the power off immediately, unplug the power cable from the AC outlet, and contact the dealer for repairs.
- To cut off the power supply to the Display completely, you need to unplug the power cable from the AC outlet.
- Trying to make repairs to this unit yourself is dangerous, and must never be attempted.
- To disconnect the device from the mains power immediately unplug the power cable from the AC mains outlet socket. Always use a mains power outlet that can be easily reached.

■ Do not touch a damaged unit until it has been disconnected from the mains.

Electric shock could occur.

■ When using the LCD Display

Do not put your hands or face, or any object, near the ventilation holes on the Display.

- The air that comes out of the ventilation holes at the top of Display will be hot. Do not put your hands or face, or any object which cannot withstand heat, close to the ventilation holes, burns or damage could result.

At least two people are needed to carry or unpack this unit.

- If this unit is dropped it may cause injury or suffer damage.

Be sure to disconnect all cables before moving the Display.

- If the Display is moved while cables are still connected, they might be damaged, and fire or electric shock could result.

Disconnect the power supply plug from the wall socket as a safety precaution before doing any cleaning.

- Electric shocks can result if this is not done.

Clean the power cable regularly to prevent it becoming dusty.

- If dust builds up on the power cord plug, humidity can damage the insulation, which could cause fire. Disconnect the power cable from the mains outlet and wipe the cable with a dry cloth.

Do not stand on, or hang from the display.

- Serious damage and injury might result. Pay special attention to children and keep them out of harm's way.

Be sure to insert batteries correctly (+ and -) make sure the polarity is not reversed.

- Mishandled batteries can leak, or even explode and cause fire. This can result in serious injury and damage to property.
- Insert batteries correctly as instructed. (see page 11)

Do not use batteries with a damaged or missing outer cover.

(The outer cover is attached to the battery for safety and must not be removed doing so may cause short circuits.)

- Mishandling the batteries can cause them to short circuit, resulting in fire, injury or damage to property.

Remove the batteries from the remote control transmitter if it is not to be used for a long time.

- A battery may leak, heat, ignite or burst, resulting in fire or damage.

Do not attempt to burn or break up batteries.

- Batteries must not be exposed to excessive heat such as direct sunlight, or radiators, stoves or other heat sources.

Do not turn the Display upside down.

Do not lay the display down with its liquid crystal panel facing upwards.

Precautions for use

Unpacking

- This product is packed in a carton, together with the standard accessories.
- Any other optional accessories will be packed separately.
- This display is big and heavy and two people should be involved when it is moved or unpacked.
- After opening the carton, ensure that the contents are complete and in good condition.

Cautions when installing

Do not set up the Display outdoors.

- The Display is designed for indoor use only.

Install this unit in a location which can support its weight.

- Use an installation bracket that conforms to VESA standards

Temperature of the working environment for this unit.

- For a location that is less than 1 400m (4 593ft) above sea level: 0°C to 40°C (32°F to 104°F)
- For a location more than 1 400m (4 593ft) but less than 2 800m (9 186ft) above sea level: 0°C to 35°C (32°F to 95°F)

Do not install the unit in a location more than 2 800m (9 186ft) above sea level.

- Failure to comply with this requirement may shorten the life of the internal parts and result in malfunction.

We are not responsible for product damage, or any consequences, caused by installation in an unsuitable environment, even during the warranty period.

Do not place the display where it may be affected by salt deposit or corrosive gas.

- Failure to do so may shorten the life of the internal parts and result in malfunctions due to corrosion.

Required space for ventilation

- Make sure to leave at least 10cm (3.94") of free space above and below, and on both sides of the periphery of the display.

There should be at least 5cm (1.97") or more free space behind the display.

Specifications of the screws used to secure a wall hanging bracket that conforms to VESA standards

Inch model	Screw pitch for installation	Depth of screw hole	Screws (quantity)
55	400 mm × 400 mm	12 mm	M6 (4)

- Installing multiple displays

The LCDs in a multiple installation may expand slightly from the heat inside the main unit. This may cause malfunction.

To avoid this problem a gap of 0.5mm or more should be left between the display bezel edges at installation.

Do not take hold of the display in such a way that your fingers or hands put pressure on the liquid crystal panel.

- Do not put force on the liquid crystal panel, or press or push it, or allow it to make contact with a hard or sharp object. Applying force to the liquid crystal panel can distort the screen, make it uneven, and cause malfunction .

Changes of temperature or humidity may cause the brightness of the display to be uneven. This is not a malfunction.

- The unevenness will disappear after the display has been running for some time. If the problem persists, consult the distributor.

Red, blue or green dots on the screen are a liquid crystal panel-specific phenomenon. This is not a malfunction.

- Although the liquid crystal display is manufactured with high-precision technology, always-lighting dots or non-lighting dots may appear on the screen. This is not a malfunction.
Dot omission ratio * : 0.00013% or less
*: Calculated in sub-pixel units according to the ISO9241-307 standard.

For the detailed installation method, refer to the following websites.

https://bizpartner.panasonic.net/public/ppr/file_view/187616

Product Access and Security

When using this product, take safety measures against the following.

- Personal information being leaked via this product.
- Unauthorized operation of this product by a malicious third party.
- Interference or blocking of this product by a malicious third party.

Take sufficient measures to ensure security.

- Set a password for the PJLink protocol and restrict access to a few authorized users.
- Make your password as difficult to guess as possible.
- Change your password often.
- No Panasonic Connect Co., Ltd. personnel, or those of an affiliate company, will ever ask for your password directly. Never divulge your password should you ever receive such request.
- The connecting network must be secured by a firewall, and precautions against malware and viruses should be taken.
- Before disposing of this product, destroy all data [General settings]-[Factory settings].

Notes on Using a Wired LAN

Take the necessary antistatic measures before setting up the Display in a location prone to electrostatic interference.

- If the Display is used in a place where electrostatic discharge is frequent, such as in a carpeted venue,

disconnection of a wired LAN can become a nuisance. In such a case, remove the source of the problem, relocate the LAN cable, and install an anti-static mat.

- In rare cases, a LAN connection can be disabled by static electricity or noise. Turning the power to the Display and all the connected devices, off and on again, will most times restore the LAN connection.

The Display may not work properly in the presence of strong radio waves from a broadcast station or even a radio.

- If there should be a facility or equipment, which outputs strong radio waves near the installation, move the Display to a place far enough away to avoid the problem. Or the LAN cable can be shielded by a wrapping of metal foil that is continuous with the LAN terminal ground, or by being placed inside a metal conduit which is properly grounded at both ends.

Cleaning and maintenance

The front of the liquid crystal panel has been specially treated. Wipe the surface of the liquid crystal panel gently using only an LCD cleaning cloth, or other soft lint-free cloth.

- If the surface is particularly dirty, wipe with a soft, lint-free cloth which has been slightly dampened with pure water, or water to which one drop of a neutral detergent has been added. After this wipe with a lint-free cloth until the surface is dry.
- Do not scratch the surface of the panel with a fingernail or other hard object to remove dirt, this may damage the surface. Furthermore, avoid spraying insect repellent near the display and also avoid using any kind of solvent such as thinners near the screen. These fluids can have an adverse effect on the surface.

If the housing becomes dirty, wipe it with a soft, dry cloth.

- If the housing should become particularly dirty, wipe it with a cloth slightly dampened with water to which a drop of neutral detergent has been added. Use this cloth to wipe the cabinet and then wipe it dry with another cloth.
- Do not allow any detergent to come into direct contact with the surface of the Display. Make sure the cloth is only damp. If water droplets get inside the unit, operating problems may be the result.
- Volatile substances such as insect sprays, solvents and thinners, can harm not only the screen but also the Display housing. The coating may be adversely affected and may even peel off. Do not allow articles made of rubber or PVC to remain in contact with the Display housing for any length of time.

Using a chemical cloth

- Do not use a chemical cloth on the panel surface.
- Follow the instructions for using the chemical cloth on the Display housing.

Disposal

When you wish to dispose of this product, ask your local authority or dealer about how this should be done.

Accessories

Accessories Supply

Check that you have the accessories and items shown

Remote Control Transmitter × 1

- DPVF1663ZA



Batteries for the Remote Control Transmitter × 2

(AAA/R03/UM4 type)

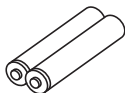

Cable-tie fastener × 3

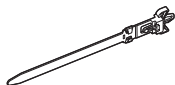

RS232C Convert Cable x1

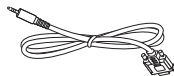

RS232 Daisy Chain Cable x 1



IR Daisy Chain Cable x 1

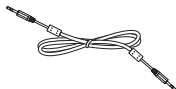

IR Receiver Cable x 1



DisplayPort Cable x 1

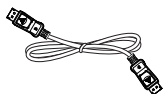

Power supply cord

(Approx. 2 m)

TH-55LFV9U

1JP155AF1U

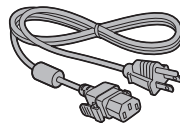

TH-55LFV9W

1JP155AF1W

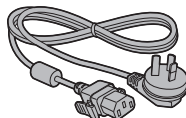

2JP155AF1W

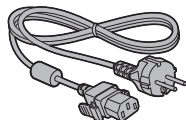

3JP155AF1W

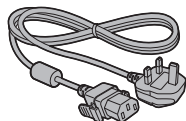

Attention

- Store small parts in a safe manner and keep them away from young children.
- The part numbers of accessories are subject to change without notice. (The actual part number may differ from the ones shown above.)
- If you should need replacements for lost accessories, please purchase them from your authorized dealer. (Available from customer service)
- Dispose of the packaging materials in the appropriate manner when no longer required.

Remote Control Batteries

1. Pull and hold the hook, then open the battery cover.

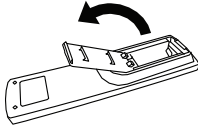

2. Insert batteries - note correct polarity (+ and -).

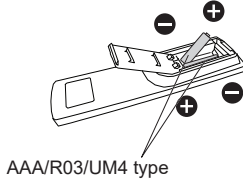

3. Replace the cover.

Helpful Hint

- When the remote control is in frequent use, replace the old batteries with Alkaline ones which have longer life.



Precautions for battery use

Incorrect installation of the batteries can cause battery leakage and corrosion that will damage the remote control device.

Discarded batteries should be dealt with in an environmentally-friendly manner.

Observe the following precaution:

1. Batteries must always be replaced as a pair. Always use new batteries when replacing the old set.
2. Do not combine a used battery with a new one.
3. Do not mix battery types (example: "Zinc Carbon" with "Alkaline")
4. Do not attempt to charge, short-circuit, disassemble, heat or burn used batteries.
5. Batteries should be replaced when the remote control works sporadically or fails to operate the Display.
6. Do not burn or break batteries open.
7. Do not leave batteries in direct sunlight, nor expose them to heat from radiators, stoves, or other sources of heat.

VESA Mounting

To mount this Display on a wall, you will need a standard wall-mounting kit (commercially available). We recommend using a mounting interface that complies with the TUV-GS and/or UL1678 standard in North America.

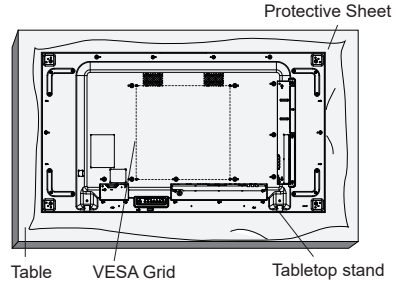

1. Lay a protective sheet on a flat table. Place the display on the sheet, screen down, so as not to scratch the screen face.
2. Ensure you have all the accessories for mounting the Display (wall mount, ceiling mount, table stand, etc).
3. Follow the instructions that come with the base mounting kit. Failure to follow the correct mounting procedure could result in damage to the equipment or personal injury. The product warranty does not cover damage caused by improper installation.
4. Use M6 mounting screws for the wall-mounting which are at least 10mm longer than the thickness of the mounting bracket. Make sure the screws are tightened securely.

Cautions when moving

The display has handles for carrying. Use them when moving the unit.

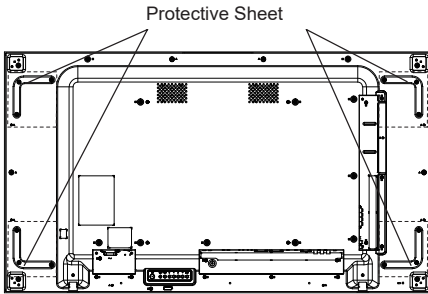

Notes

- Always hold the Display by the handles. Do not hold it by any other part.
- At least two people are needed to carry this unit. If this precaution is not taken, the unit may be dropped, resulting in both damage and personal injury.
- When carrying the unit, keep the liquid crystal panel vertical. Carrying the unit with the surface of the liquid crystal panel facing upwards or downwards may cause deformation of the panel, or internal damage.
- Do not handle the Display by the edges or corners. Do not support the display by using your hands on the front surface. Also, make sure that nothing collides with the front surface of the display. A blow to the front of the Display can damage the LCD screen. Furthermore, the glass panel might crack and cause personal injury

Kensington security lock

The security slot of this unit is compatible with the Kensington security cables.

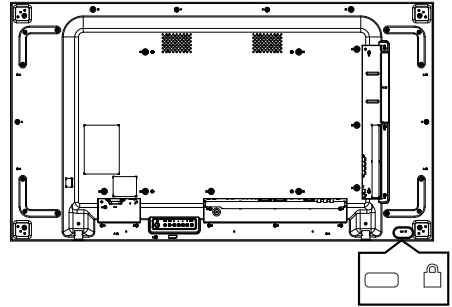

Identifying Controls

Main unit

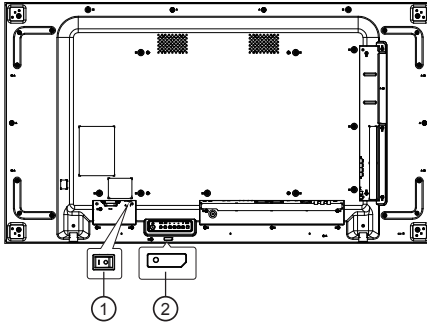

① Main power switch (○ / I)

Switches the main power ON (I) / OFF (○).

- Turning ON/OFF the <Main power switch> is the same as plugging or unplugging the power cable plug. Switch the <Main power switch> ON (I), and then turn the power ON / OFF with the remote control or <Power button (Unit)>

② Power Indicator / Remote control sensor (Back of the unit)

The Power Indicator will light.

When the power of the unit is ON (Main power switch: ON (I))

- Picture is displayed: Green
- Power OFF (standby):
 - When [General settings]-[Eco mode] is set to [low power standby]:Red
 - When [General settings]-[Eco mode] is set to [normal]:Orange

When the power to the unit is OFF (Main power switch: OFF (○)): No light

Note

- When the power indicator is orange, power consumption during standby is larger than that of when the power indicator is red.

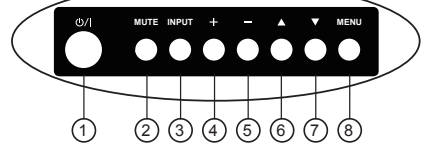
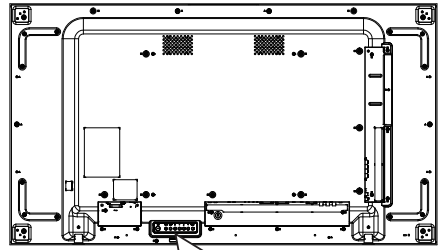

① [○ / I] button

Use this button to turn the Display on or put it into standby.

② [MUTE] button

Switch audio mute ON/OFF.

③ [INPUT] button

Choose the input source.

- Used as [ENTER] in the On-Screen-Display menu.

④ [+] button

Increase the adjustment while the OSD menu is on, or increase the audio output level when the OSD menu is off.

⑤ [-] button

Decrease the adjustment while the OSD menu is on, or decrease the audio output level when the OSD menu is off.

⑥ [▲] button

Move the highlight bar up to adjust the selected item while the OSD menu is on.

⑦ [▼] button

Move the highlight bar down to adjust the selected item while the OSD menu is on.

⑧ [MENU] button

Return to the previous menu while the OSD menu is on, or to activate the OSD menu when it is off.

Interface

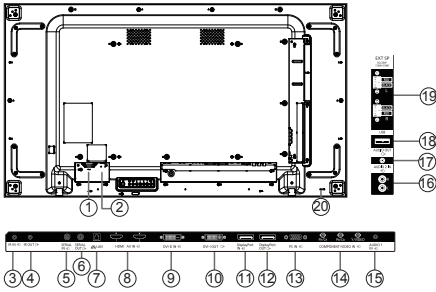

- ① AC IN**
AC power input from a wall outlet.
- ② MAIN POWER SWITCH**
Switch the main power on/off.
- ③ IR IN / ④ IR OUT**
IR signal input / output for the loop-through function.
- Notes**
- The Display's remote control sensor will stop working if the jack [IR IN] is connected.
 - To remotely control your A/V device via this Display, refer to the IR Pass Through connection.
- ⑤ SERIAL IN / ⑥ SERIAL OUT**
RS232C network input / output for the loop-through function.
- ⑦ LAN**
LAN control function for remote control signals from the control centre.
- ⑧ HDMI AV IN**
HDMI video/audio input.
- ⑨ DVI IN**
DVI-D video input.
- ⑩ DVI OUT (VGA OUT)**
DVI or VGA video output.
- ⑪ DisplayPort IN / ⑫ DisplayPort OUT**
DisplayPort video input / output.
- ⑬ PC IN (D-Sub)**
VGA video input.
- ⑭ COMPONENT / VIDEO IN (BNC)**
Component YPbPr/YCbCr, Video input.

- ⑮ AUDIO 1 IN**
Audio input for PC and DVI source (3.5mm stereo phone).
- ⑯ AUDIO 2 IN**
Audio input from external AV device (RCA).
- ⑰ AUDIO OUT**
Audio output to external AV device.
- ⑱ USB PORT**
Connect your USB storage device.
- ⑲ SPEAKERS OUT**
Audio output to external speakers.
- ⑳ SECURITY LOCK**
Used for security and theft prevention.

Remote Control

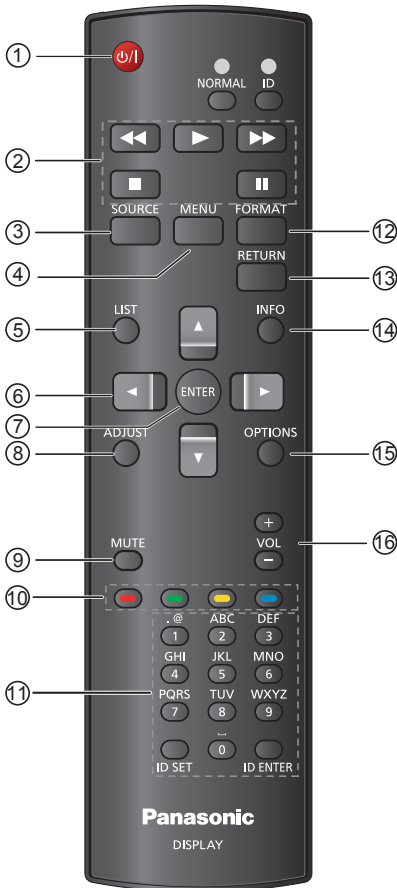

- ① **[POWER] button**
To turn the Display on or put it in standby mode.
- ② **[PLAY] buttons**
Used to play USB media file.
- ③ **[SOURCE] button**
Choose input source. Press the [▲] or [▼] button to choose from USB, HDMI1, HDMI2, DisplayPort, DVI-D, COMPONENT, VIDEO or PC Press [ENTER] to confirm and exit.

- ④ **[HOME] button**
Access the OSD menu.
- ⑤ **[LIST] button**
No function.
- ⑥ **[NAVIGATION] buttons**
Navigate the menus and choose items.
- ⑦ **[ENTER] button**
Confirm an entry or selection.
- ⑧ **[ADJUST] button**
Access currently available picture, picture shift and sound menus.
- ⑨ **[MUTE] button**
Press to turn the mute function on/off.
 - When the Onscreen display shows the No signal display, mute is not displayed on the screen.
- ⑩ **[COLOUR] buttons**
Used to play USB media file.
- ⑪ **[Number / ID SET / ID ENTER] button**
Enter text for network setting.
Press to set the Display ID. Refer to ID Remote Control for more detail.
- ⑫ **[FORMAT] button**
Change aspect ratio.
- ⑬ **[BACK] button**
Return to the previous menu page or exit from the previous function.
- ⑭ **[INFO] button**
View info about the Display.
- ⑮ **[OPTIONS] button**
Used to play USB media file.
- ⑯ **[VOLUME] button**
Adjust volume on internal or external audio sources.
 - When the Onscreen display shows the No signal display, volume will not be displayed on the screen.

Set the remote control ID when you want to use this remote control on several different Displays.



Press the [ID] button. The red LED will blink twice.

1. Press the [ID SET] button for more than one second to enter the ID Mode. The red LED will come on. Pressing the [ID SET] button again will exit the ID Mode. The red LED will go off.

Press digits [0] ~ [9] to select the Display you want to control.

For example: press [0] and [1] for Display No. 1, press [1] and [1] for Display No. 11.

The numbers available are from [01] ~ [255].

2. The ID Mode will terminate if no selection is made within 10 seconds.
3. If a button other than a digit is pressed by mistake, wait for one second after the red LED goes off and comes on again. Now choose the correct digits.
4. Press [ID ENTER] to confirm. The red LED will blink twice and then go off.

Notes

- Press the [NORMAL] button. The green LED blinks twice, to indicate the Display is in normal operation mode.
- It is necessary to set up the Monitor ID for each Display before selecting its ID number.

Connections

AC cord connection

Back of the unit

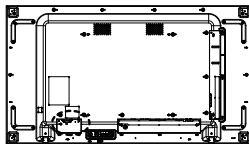

AC cord attachment

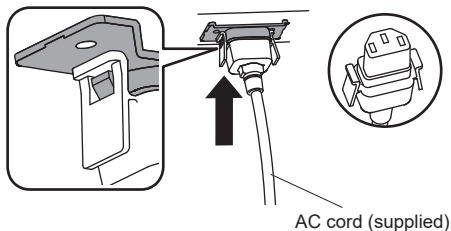

Plug the connector into the display unit.

Push it into the socket until it clicks.

Note

- Make sure that the connector is locked on both sides.

Unplugging the AC cord

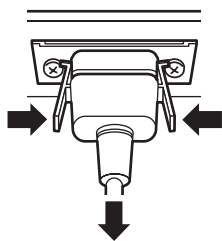

Unplug the connector by squeezing the two catches.

Notes

- Be absolutely sure to unplug the AC mains cable from the wall socket before disconnecting it from the Display.
- The AC cord supplied with the Display is for exclusive use with this Display. Do not use it for other purposes.

Cable fixing

Note

- Three cable fasteners are supplied with this unit. Fix the cables at three locations using the holes provided, as shown below.

If you need more fasteners, purchase them from your dealer. (Available from customer service)

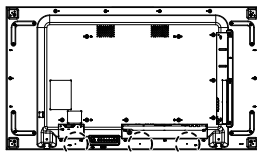

1. Attach the cable fasteners

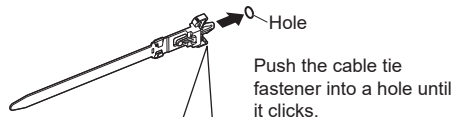

To remove from the unit:

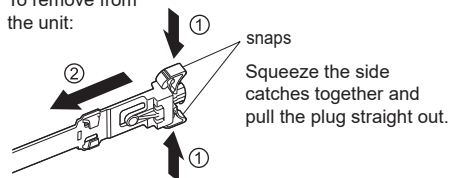

2. Bundle the cables

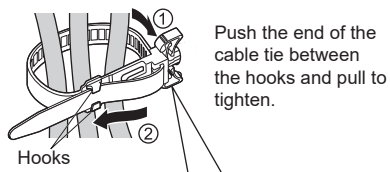

To loosen:

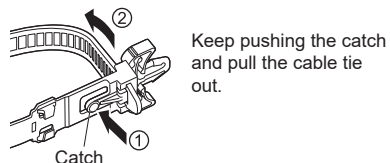

Before connecting

- Before connecting cables, carefully read the operating instructions for the external device to be connected.
- Turn the power off to all devices before connecting any cables.
- Take note of the following points before connecting the cables. Failure to do so may result in malfunction.
 - When connecting a cable to the unit or a device connected to the unit itself, touch a nearby metallic object to eliminate the chance of a static discharge that could damage electronic components.
 - Do not use unnecessarily long cables to connect a device to the unit or to the unit body. The longer the cable, the more susceptible will it be to noise. Do not leave cables coiled, the coils can pick up noise by induction and they also act as radio antennae.
 - When connecting cables, connect the GND first, then insert the connecting terminal of the device.
- Acquire any cable needed to connect the external device to the system that is not supplied with the device nor available as an option.
- If a plug is too big it can make contact with adjacent plugs, or parts of the device itself and this will interfere with proper connection. Use a cable with a suitable plug size to ensure proper alignment and connection.
- When connecting a LAN cable with a plug cover, be aware that the cover may come in contact with the back cover of the Display and it may be difficult to disconnect the cable.
- If signals from video equipment contain too much jitter, the images on the screen may wobble. In this case, a time base corrector (TBC) must be connected.
- When the sync signal output from the PC or video equipment is disturbed, such as might happen when video output settings are changed, the video image might change colour momentarily.
- The unit accepts Composite video signals, YC_BCR/YP_BPR signals (PC IN), analogue RGB signals (PC IN) and digital signals.
- Some PC models are not compatible with this unit.
- Use a cable compensator when long cables must be used to connect devices to the unit. Otherwise the image may not display correctly.

PC Input Terminals connection

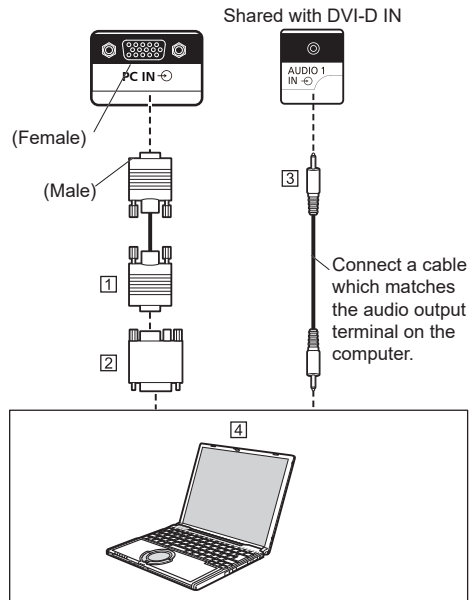

- 1 Mini D-sub15p cable (commercially available)
- 2 a conversion adapter is commercially available if needed.
- 3 Stereo mini plug M3 cable (commercially available)
- 4 PC

Notes

- The Display will accept computer signals with a horizontal scanning frequency of 30 to 110 kHz and a vertical scanning frequency of 48 to 120 Hz. (However, images with more than 1,200 lines will not display correctly.)
- The Display resolution maximum is 1,440 × 1,080 dots when the aspect mode is set to "4:3", and 1,920 × 1,080 dots when the aspect mode is set to "16:9". If the Display resolution exceeds these maxima, it may not be possible to show fine detail with sufficient clarity.
- The PC input terminals are DDC2B-compatible. If the computer is not DDC2B-compatible, changes will have to be made to the settings when the connection is made.
- Some PC models cannot be connected to the Display.
- There is no need to use an adapter for computers with a DOS/V compatible Mini D-sub 15P connector.
- The computer shown in the illustration is for example purposes only.
- Additional equipment and cables shown are not supplied with this Display.
- Do not set horizontal and vertical scanning frequencies for PC signals which are above or below the specified frequency range.

Signal Names for Mini D-sub 15P Connector

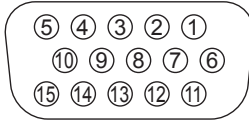

Pin Layout for PC Input Terminal

Pin No.	Signal Name
①	R
②	G
③	B
④	NC (not connected)
⑤	GND (Ground)
⑥	GND (Ground)
⑦	GND (Ground)
⑧	GND (Ground)
⑨	+5 V DC
⑩	GND (Ground)
⑪	NC (not connected)
⑫	SDA
⑬	HD/SYNC
⑭	VD
⑮	SCL

VIDEO IN connection

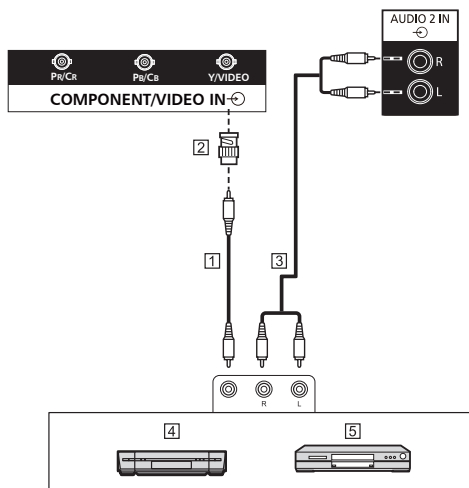

- ① Video pin cable (commercially available)
- ② Pin-BNC conversion plug (commercially available)
- ③ Stereo audio cable (commercially available)
- ④ Video Cassette Recorder
- ⑤ DVD Player

Note

- Video equipment, connection cables and conversion plugs are not supplied with this unit.

COMPONENT connection

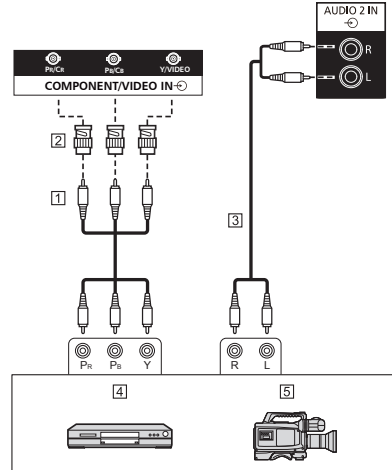

- ① Video pin cable (commercially available)
- ② Pin-BNC conversion plug (commercially available)
- ③ Stereo audio cable (commercially available)
- ④ DVD Player
- ⑤ RGB camera

Note

- Video equipment, connection cables and conversion plugs are not supplied with this unit.

AUDIO OUT connection

Notes

- AUDIO OUT is an exclusive terminal for external audio equipment.
- Additional equipment and cables shown are not supplied with this set.

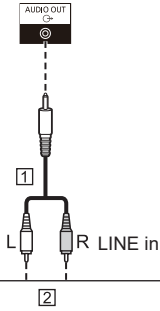

1 Stereo audio cable (commercially available)

2 Audio equipment

Speaker connection

Please use an 8Ω/10W speaker.

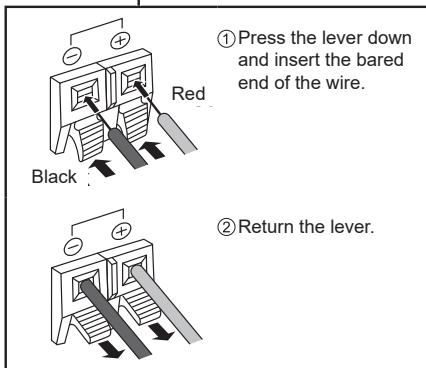
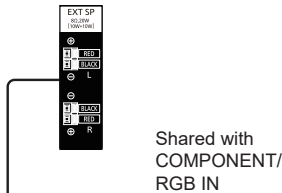

HDMI1, HDMI2 connection

Notes

- Video equipment and HDMI cable shown are not supplied with this unit.
- Some HDMI equipment may not work with this Display.
- This Display does not support HDMI-CEC (HDMI Consumer Electronics Control) (VIERA LINK).

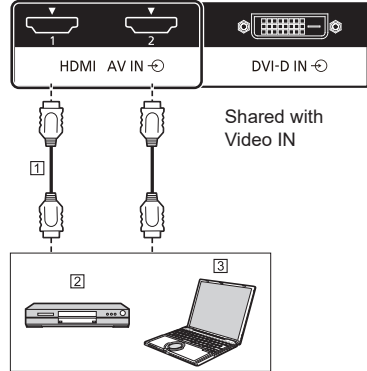

1 cable (commercially available)

2 DVD Player

3 PC

Pin assignments and signal names

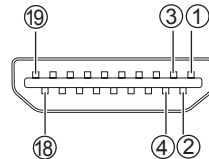

Pin No.	Signal Name
1	T.M.D.S. Data2 +
2	T.M.D.S. Data2 Shield
3	T.M.D.S. Data2 -
4	T.M.D.S. Data1 +
5	T.M.D.S. Data1 Shield
6	T.M.D.S. Data1 -
7	T.M.D.S. Data0 +
8	T.M.D.S. Data0 Shield
9	T.M.D.S. Data0 -
10	T.M.D.S. Clock +
11	T.M.D.S. Clock Shield
12	T.M.D.S. Clock -

Pin No.	Signal Name
⑬	—
⑭	Reserved (NC on device)
⑮	SCL
⑯	SDA
⑰	DDC/CEC Ground
⑱	+5 V DC
⑲	Hot Plug Detect

DVI-D input / DVI-I output connection

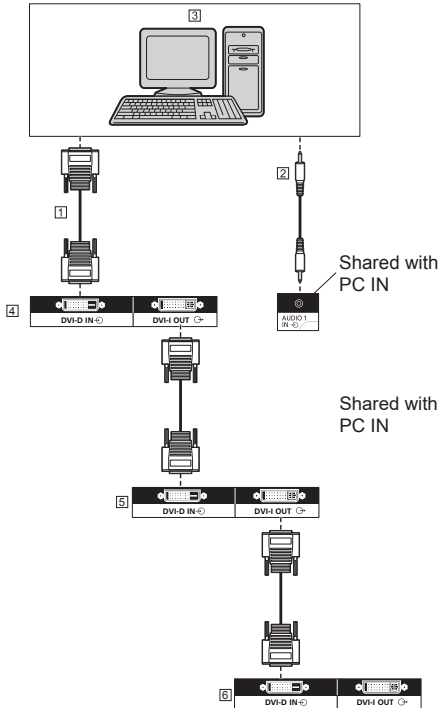

- ① DVI-D cable (commercially available)
- ② Stereo mini plug M3 cable (commercially available)
- ③ PC with DVI video out
- ④ First display
- ⑤ Second display
- ⑥ Third display

Pin assignments and signal names for DVI-D input / DVI-I output

DVI-D input

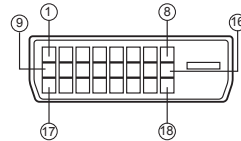

DVI-I output

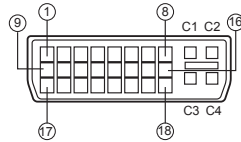

Pin No.	DVI-D Signal Name	DVI-I Signal Name
①	T.M.D.S. Data2 -	
②	T.M.D.S. Data2 +	
③	T.M.D.S. Data2 Shield	
④	—	
⑤	—	
⑥	DDC Clock	
⑦	DDC Data	
⑧	—	
⑨	T.M.D.S. Data1 -	
⑩	T.M.D.S. Data1 +	
⑪	T.M.D.S. Data1 Shield	
⑫	—	
⑬	—	
⑭	+5 V DC	
⑮	Ground	
⑯	Hot Plug Detect	
⑰	T.M.D.S. Data0 -	
⑱	T.M.D.S. Data0 +	
⑲	T.M.D.S. Data0 Shield	
⑳	—	
㉑	—	
㉒	T.M.D.S. Clock Shield	
㉓	T.M.D.S. Clock +	
㉔	T.M.D.S. Clock -	
C1	—	Analog Red
C2	—	Analog Green
C3	—	Analog Blue
C4	—	Analog H sync

Notes

- Additional equipment and cables shown are not supplied with this unit.
- This model cannot be connected to other models of Display.

DisplayPort input/output connection

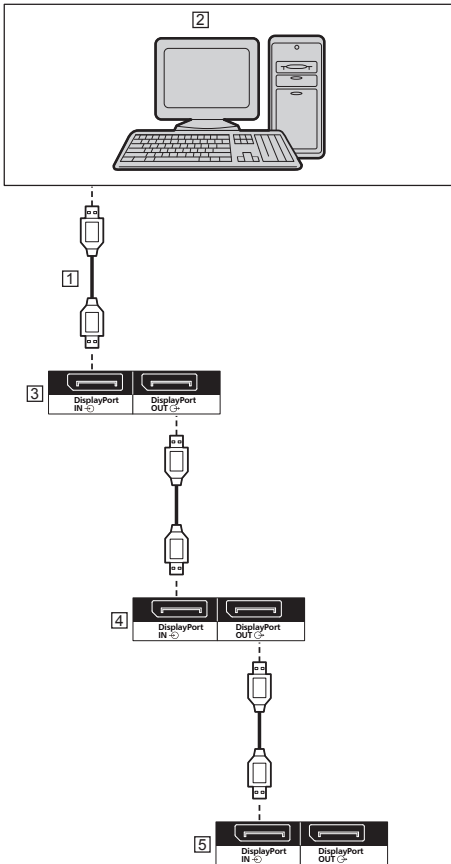

- ① DisplayPort cable (supplied)
- ② PC with DisplayPort output
- ③ First display
- ④ Second display
- ⑤ Third display

Pin assignments and signal names for DisplayPort

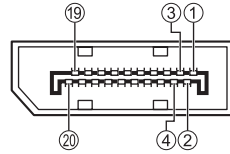

Pin No.	Signal Name
①	Lane0(p)
②	GND
③	Lane0(n)
④	Lane1(p)
⑤	GND
⑥	Lane1(n)
⑦	Lane2(p)
⑧	GND
⑨	Lane2(n)
⑩	Lane3(p)
⑪	GND
⑫	Lane3(n)
⑬	Config1
⑭	Config2
⑮	AUX_CH (n)
⑯	GND
⑰	AUX_CH (p)
⑱	Hot Plug Detect
⑲	DP Power_Return
⑳	DP Power

Notes

- DisplayPort Input supports DP++ only.

SERIAL terminal connection

The SERIAL terminal conforms to the RS-232C interface specification, so that the Display can be controlled by a computer which is connected to this terminal.

Notes

- The serial conversion cable is supplied with this unit.

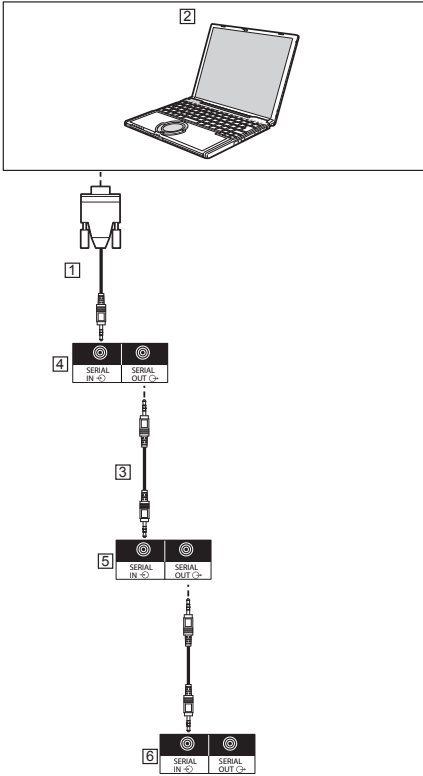

- 1 RS232 convert cable (supplied)
- 2 PC
- 3 RS232 Daisy Chain Cable (supplied)
- 4 First display
- 5 Second display
- 6 Third display

Pin assignments and signal names for SERIAL Terminal

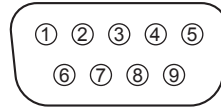

Pin No.	Signal Name	
1	NC (no connection)	
2	RXD	
3	TXD	
4	Not used	
5	GND (Ground)	
6	Not used	
7	RTS	Shorted in this unit
8	CTS	
9	NC (no connection)	

These signal names are computer specifications.

Communication parameters:

Signal level: RS-232C compliant

Synchronization method: Asynchronous

Baud rate: 9600 bps

Parity: None

Character length: 8 bits

Stop bit: 1 bit

Flow control: None

Basic format for control data

The transmission of control data from the computer starts with an STX signal, followed by the command, the parameters, and lastly an ETX signal in that order. If there are no parameters, no parameter signal is sent.

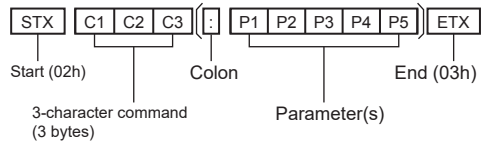

Command

Command	Parameter	Control details
PON	None	Power ON
POF	None	Power OFF
AVL	***	Volume 000 - 060
AMT	0	Audio MUTE OFF
	1	Audio MUTE ON
IMS	None	Input select (toggle)
	HM1	HDMI1 input (HDMI1)
	HM2	HDMI2 input (HDMI2)
	DP1	DisplayPort IN input (DisplayPort)
	DV1	DVI-D IN input (DVI-D)
	PC1	PC IN input (PC)
	VD1	VIDEO input (VIDEO)
	YP1	COMPONENT input (COMPONENT)
	UD1	USB input (USB)
MDC	0	Tiling Enable Off
	1	Tiling Enable On
DAM	None	Picture format select (toggle) (*1)
	AUZM	Auto zoom (*1)
	MOEX	Movie expand 16:9 (*1)
	WISC	Wide screen (*1)
	UNSC	Unscaled (*1)
	NM43	4:3 (*1)
VPC	BLT***	Backlight 000 ~ 100 (*1)
AAC	AOV***	Audio out (External Audio output) volume 000 ~ 060

(*1) When sending the DAM or VPC command, ensure that the images are normally displayed with stability beforehand. When sending a command after switching the input, 1200 ms or more of time interval is required after the input switching.

Attention

- Intervals between multiple commands should be at least 750 ms.
- When sending multiple commands, be sure to receive a response from this unit before sending the next command. When sending a command that does not require a parameter, no colon (:) is necessary.
- When using the serial control, set {Eco mode} to "Normal", and {APM} to "Off". (⇒ See page 31, 33)
- When using Video Wall Manager, turn the power "On" of this unit beforehand. Also, set {Eco mode} to "Normal", and {APM} to "Off". (⇒ See page 31, 33)

Notes

- If a wrong command has been sent, the command "ER401" will be returned to the PC.
- In the standby state (power turned off by remote control or the Display power button) When "Eco mode" is set to "normal" operations other than the "PON" command cannot be guaranteed.

- When "Eco mode" is set to "low power standby" operations other than the "PON" command cannot be guaranteed. Also, the "PON" command does not respond.
- Only commands to monitors with corresponding IDs will be accepted. The formats are shown below.
(Type1) AD94;RAD:<XXX>;
(Type2) RAD:<XXX>;
<XXX> represents monitor ID 001 to monitor ID 100, or 000.
000 is the simultaneous transmission command (ID all command) to all the monitors.
- When using the monitors in a serial daisy chain, set the Monitor ID to avoid overlapping in all displays, and use commands with ID.
- When checking the setting values on the menu of this unit, send a command beforehand. If the command is sent with the menu displayed, close the menu once and open it again to check.
- Do not send the RS232C command and PLink command simultaneously. The RS232C command cannot be received while the PLink command is being processed. Also, no response is returned to the RS232C command. When using the both RS232C command and PLink command, use the RS232C command with an ID appended (ID: 001 to 100). If no response is returned, resend the command.
- For command details, consult the dealer from which the product was purchased.
Or, visit the support site shown below.
<https://panasonic.net/cns/prodisplays/>
- Video Wall Manager
This unit supports the "Video Wall Manager" software which adjusts multiple displays simultaneously or separately on one computer without the need to rearrange cables.
- For more details, visit the following web site.
<https://panasonic.net/cns/prodisplays/download/software/index.html>

IR terminal connection

It is possible to receive signals from the remote control by connecting the supplied external IR receiver to the IR IN terminal.

Notes

- An external IR receiver is supplied with this unit.
- If the external IR receiver or the IR cable is connected to the IR IN terminal of the Display, control is limited to this Display.
- The remote control signal may not be received due to the outside light or shielding objects.
- Since the remote control signal is an asynchronous signal to this unit, if common operations are performed to this unit in daisy chain, some operations may not be accepted.

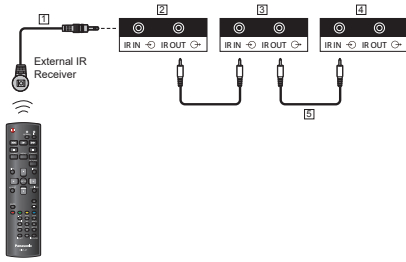

- 1 External IR receiver (supplied)
- 2 First display
- 3 Second display
- 4 Third display
- 5 IR Daisy Chain Cable (supplied)

USB terminal connection

Connect a USB device to use [USB media player].

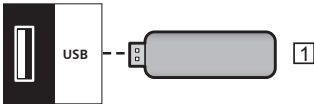

- 1 USB memory device

Pin assignments and signal names for USB Terminal

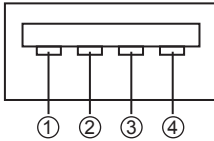

Pin No.	Signal name
1	+5 V DC
2	DATA -
3	DATA +
4	GND (Ground)

Notes

- Some types of USB device may be too big to fit into the socket. Use a commercially available extension cable, or use a smaller type of USB memory device that will fit this Display.
- Some types of USB memory may cause the access light to continue blinking even when they are not being accessed. In this case, switch to another input and remove the USB.

Connecting Multiple Displays in a Daisy-chain configuration

You can connect multiple Displays to create a daisy-chain configuration for applications such as a video wall.

Display control connection

Connect the [SERIAL OUT] connector of DISPLAY 1 to the [SERIAL IN] connector of DISPLAY 2.

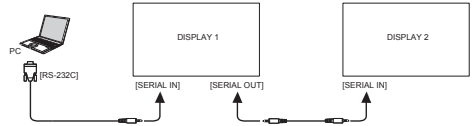

Connect the [IR OUT] connector of DISPLAY1 to the [IR IN] connector of DISPLAY2

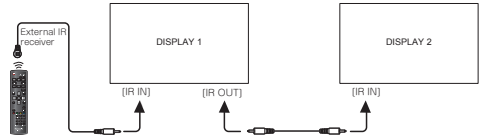

Digital video connection

Connect the [DVI OUT (VGA OUT)] connector of DISPLAY 1 to the [DVI IN] connector of DISPLAY 2.

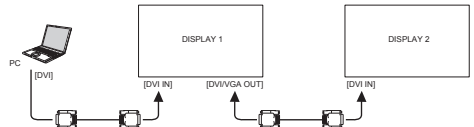

Connect the [DP OUT] connector of DISPLAY 1 to the [DP IN] connector of DISPLAY 2.

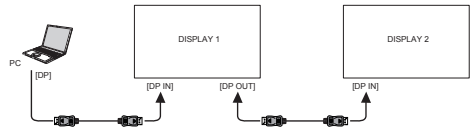

Connect the [DVI OUT] connector of DISPLAY 1 to the [DVI IN] connector of DISPLAY 2.

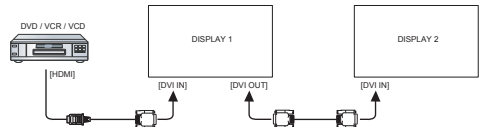

Analogue video connection

Connect the [DVI OUT (VGA OUT)] connector of DISPLAY 1 to the [VGA IN] connector of DISPLAY 2.

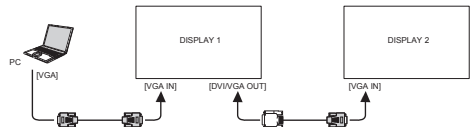

Basic controls

1. Connect the AC cord to the Display.
2. Connect the cord to an AC outlet.

Notes

- The control button referred to in this section is the one on the remote control unless specified otherwise.
- Mains plug types vary between countries. The power plug shown here may not be the same as the one on your set.
- When disconnecting the AC cord, be sure to always disconnect the cord at the AC socket outlet first.
- 3. Switch the <Main power switch>.
- 4. Turn the power ON/OFF with the remote control or <Power button (Unit)>.

Watch the Connected Video Source

See page 18 for external equipment connections.

1. Press the **[SOURCE]** button.
2. Press **[M]** or **[I]** to choose a device, then press **[ENTER]**.

Change Picture Format

You can change the picture format to suit the video source. Each video source has available picture formats.

The available picture formats depend on the video source:

1. Press the **[FORMAT]** button.
2. Press **[M]** or **[I]** to choose a picture format, then press **[ENTER]**.
 - {Auto zoom}: Enlarge picture to fill the screen. Recommended for minimal screen distortion but not for HD or PC.
 - {Movie expand 16:9}: Scale 4:3 format to 16:9. Not recommended for HD or PC.
 - {Wide screen}: Shows wide screen format unstretched. Not recommended for HD or PC.
 - {Unscaled}: Provides maximum detail for PC.
 - {4:3}: Displays classic 4:3 format.

Choose your Preferred Picture Settings

1. Press the **[ADJUST]** button while a video is being played.
2. Press the **[←]** or **[→]** button to choose **Picture style**, then press **[ENTER]**.
3. Press the **[M]** or **[I]** button to choose an option, then press **[ENTER]**:
 - {Personal}: Apply your personalised picture settings.
 - {Vivid}: Rich and dynamic settings, ideal for daytime viewing.

- {Natural}: Natural picture settings.
- {Standard}: Default settings that suit most environments and types of video.
- {Movie}: Ideal settings for movies.
- {Photo}: Ideal settings for photos.
- {Energy saving}: Settings that conserve the most energy.

Choose your Preferred Sound Settings

1. Press the **[ADJUST]** button while a video is being played.
2. Press the **[←]** or **[→]** button to choose **Sound style**, then press **[ENTER]**.
3. Press the **[M]** or **[I]** button to choose an option, then press **[ENTER]**:
 - {Personal}: Apply your personalised sound settings.
 - {Original}: Settings that suit most environments and types of audio.
 - {Movie}: Ideal settings for movies.
 - {Music}: Ideal settings for listening to music.
 - {Game}: Ideal settings for games.
 - {News}: Ideal settings for spoken audio, such as the news.

Play multimedia files from a USB device

1. Connect your USB device to the USB port on the Display.

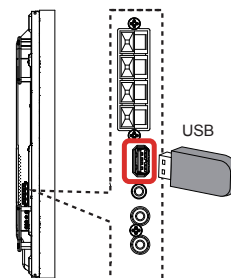

2. Press the **[SOURCE]** button, choose **USB**, and press **[ENTER]**.

Note

- When it display the menu, it returns to the previous input.
- USB memory devices other than those formatted in FAT16 or FAT32 cannot be used.

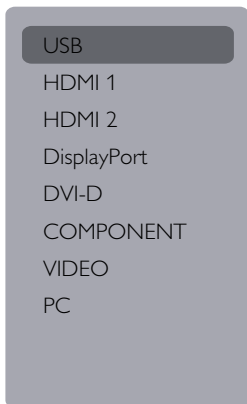

- The connected USB device will be detected automatically and all the playable files will be sorted into 3 types: **Music**, **Movie**, and **Photo**.

Photo

- Press **[RETURN]** to go up to the top layer on the screen. Press the **[←]** or **[→]** button to choose the file type. Press **[ENTER]** to open the play list.
- Choose the file you want. Press **[ENTER]** to start playing.
- Follow the on-screen instructions to control play options.
- Press the **[PLAY]** buttons (**[■] || ◀ ▶ ▶▶**) to control playing.

Playing music files.

- Choose **Music** in the top bar.



- Choose a music track and press **[ENTER]**.
 - To play all the tracks in a folder, choose the music file. Then, press **[REDACTED]** to **Play All**.
 - To select the next or previous track, press **[I]** or **[J]**.
 - To pause the track, press **[ENTER]**. Press **[ENTER]** again to resume playback.
 - To skip backwards or forwards 10 seconds, Press **[←]** or **[→]**.
 - To search backwards or forwards, Press **[◀◀]** or **[▶▶]**, continue pressing to toggle between different speeds.
 - To stop the music, press **[■]**.

Music options

While music is playing, press **[OPTIONS]**, then press **[ENTER]** to choose an option:

- {Shuffle}: Enable or disable random track play.
- {Repeat}: Choose {Repeat} to loop a track or an album, or choose {Play once} to play a track once.

Note

To view information about a song (such as, title, artist or duration), choose the song, then press **[INFO]**. To hide the information, press **[INFO]** again.

Playing movie files

- Choose **Movie** in the top bar.



- Choose a video and press **[ENTER]**.
 - To play all the videos in a folder, choose one video file. Then, press **[REDACTED]** to **Play All**.
 - To pause the video, press **[ENTER]**. Press **[ENTER]** again to resume playback.
 - To move backwards or forwards 10 seconds, press **[←]** or **[→]**.
 - To search backwards or forwards, press **[◀◀]** or **[▶▶]**. Continue pressing to toggle between different speeds.
 - To stop the video, press **[■]**.

Movie options

While a video is playing, press **[OPTIONS]**, then press **[ENTER]** to choose:

- {Subtitles}: Choose the available subtitle settings.
- {Subtitle Language}: Choose the language for subtitles if available.
- {Shuffle}: Enable or disable random play of video files.
- {Repeat}: Choose {Repeat} to loop the video or {Play once} to play it once.
- {Status}: To view information about a video (for example, played position, duration, title, or date).

Playing photo files

- Choose **Photo** in the top bar.





- Choose a photo thumbnail, then Press **[ENTER]**.

Start a slideshow

Choose a photo if there is more than one in the folder.

Then press [] to **Play All**.

- To select the previous or next photo, press [] or [] and then press [ENTER].
- To stop the slideshow, press [].

Slideshow options

While playing a slideshow, press [OPTIONS], then press [ENTER] to choose:

- {Shuffle}: Enable or disable the random display of slideshow pictures.
- {Repeat}: Choose {Repeat} to loop a slideshow or {Play once} to watch once.
- {Slideshow Time}: Choose the display time for each photo.
- {Slideshow Transitions}: Choose the kind of transition between photos.

Function controls

Using the remote control:



1. Press **[MENU]** to display the OSD menu.
2. Press the **[▲]** **[▼]** **[←]** or **[→]** to choose **Picture**, **Sound**, **Tiling**, **General Settings** or **Network settings**. Press **[ENTER]**.
3. Press **[▲]** **[▼]** **[←]** or **[→]** to choose a menu item or to adjust its value. Press **[ENTER]** to confirm.
4. Press **[RETURN]** to go back to the previous menu layer.
5. Press **[MENU]** to exit the OSD menu.

Using the Display control buttons

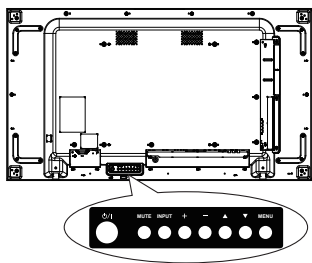

1. Press **[MENU]** to Display the OSD menu.
2. Press **[▲]** **[▼]** **[+]** or **[−]** to choose a menu item or adjust its value.
3. Press **[INPUT]** to confirm selection and enter the submenu.
4. Press **[MENU]** to exit the OSD menu.

Picture

menu

Picture	Picture style
Sound	Restore style
Tiling	Backlight
General settings	Color
Network settings	Sharpness
	Noise reduction
	MPEG artifact reducti...
	Digital Crystal Clear
	Advanced
	Game or computer
	Format and edges

Picture style

Choose a predefined picture setting.

Restore style

Restore the last predefined picture setting.

Backlight

Adjust the backlight brightness.

Colour

Adjust the picture colour saturation.

Sharpness

Adjust the picture sharpness.

Noise reduction

Choose the degree of picture noise reduction.

MPEG artefact reduction

Smooth transition and haziness in the digital picture.

Digital Crystal Clear

Produce a brilliant, high-definition image by fine tuning each pixel to match surrounding neighbours.

- {Advanced sharpness}: Enable extra picture sharpness, specially on lines and contours.
- {Dynamic contrast}: Dynamically enhance detail in dark, medium and light areas of the picture.
- {Colour enhancement}: Dynamically enhance vividness and colour detail.

Advanced

Access advanced settings such as gamma, tint, video contrast and so on.

- {Gamma}: Make non-linear adjustments to picture luminance and contrast.
- {Tint}: Change the colour balance.
- {Custom tint}: Customise colour balance setting. Only available when {Tint} → {Custom} has been chosen.
- {Video contrast}: Adjust video contrast.
- {Brightness}: Adjust screen brightness.
- {Hue}: Adjust screen hue.

Game or computer

Set the TV mode/PC mode.

- {Off}: Set automatically for the input signal.
- {Game}: Fix to the TV mode.
Detailed screen adjustment is possible.
- {Computer}: Fix to the PC mode.
Screen adjustment items are limited.

HDMI input range

Change the range of HDMI input signals.

- {Auto}: Automatic detection
- {Limit}: 16 to 235 signals
e.g., HDMI terminal output of DVD player
- {Full}: 0 to 255 signals
e.g., HDMI terminal output of PC

Format and edges

- {Picture format}: Change the picture format.
- Input resolution
Resolution settings for the following signals is input from the PC: 1366x768@60 / 1360x768@60 / 1280x768@60 / 1024x768@60 or 1400x1050@60 / 1680x1050@60

Notes

- Switch the settings of the input signal to suit the display and angle of view so that the image is clearly visible and easy to see.
- When DVI, PC and PC signal input to other terminal, there are menus not to be displayed.

Sound

Picture	Sound style
Sound	Restore style
Tiling	Bass
General settings	Treble
Network settings	Balance
	Surround mode
	Audio out
	Advanced

Sound style

Access predefined sound settings.

Restore style

Restore the last selected predefined sound setting.

Bass

Adjust to increase or decrease bass.

Treble

Adjust to increase or decrease treble.

Balance

Adjust to balance left and right channel audio output.

Surround mode

Set surround sound effect.

Audio out

Adjust audio output volume.

Advanced

Access advanced settings to enhance your audio experience.

- {Auto volume levelling}: Enable balanced reduction of sudden volume change.
- {Speaker settings}: Turn the external speakers on or off.
- {Clear sound}: Enhance sound quality.

Tiling

Picture	Enable
Sound	H monitors
Tiling	V monitors
General settings	Position
Network settings	Frame comp.

With this function you can create a single large-screen matrix video wall of up to 100 individual Displays, 10 vertical and 10 horizontal.

Notes

- With a 4K signal input, values of up to "5" can be set for "H monitors" and "V monitors".
- The Tile function is not available with USB input.

Enable

Choose {On} or {Off} for the Tiling function. If {On}, the Display will apply the settings in {H monitors}, {V monitors}, {Position}, and {Frame comp.}.

H monitors

Adjust horizontal Displays.

V monitors

Adjust vertical Displays.

Position

Adjust the position of this Display in the screen matrix.

Example: 5 x 5 screen matrix (25 Displays)
 H monitors = 5 Displays
 V monitors = 5 Displays

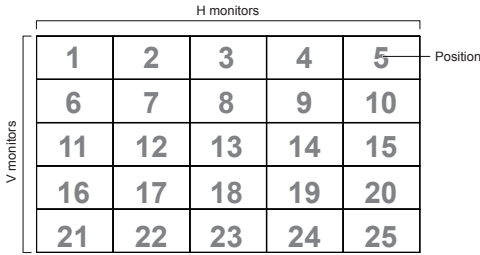

Frame comp.

Turn the frame compensation function on or off. When selected {On}, the displayed image will be adjusted to compensate for the width of the Display bezel to give a more accurate image.

General Settings

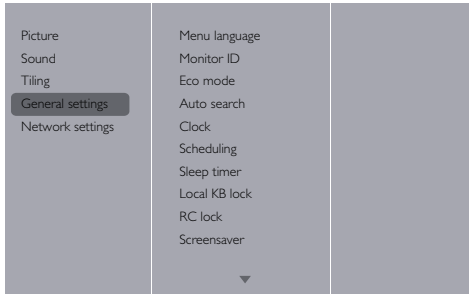

Menu language

Choose language for the OSD menus.

Monitor ID

Set the ID number for SERIAL control of the Display. Each display must have a unique ID number when multiple sets are connected. Monitor ID number range is between 1 to 255. The default setting is 1.

Eco mode

Set this Display to reduce power consumption automatically.

Notes

- Set this mode to "Normal" when turning the Display on quickly.
- Set this mode to "Normal" when using the serial and PLink control.
- Set this mode to "Normal" when using Multi Monitoring & Control, or the Video Wall Manager.

Auto search

Choose to allow this device to detect and display available signal sources automatically.

- {Off}: The input is not switched automatically.

- {On}: Searches all inputs and switches to an input with a signal.
- {Failover/Failback}: Searches select input and switches.

Note

- When selecting "USB auto play" with Failover/ Failback, place the movie file and photo file in a folder named "autoplay" created in the top level of the USB memory.

Clock

Set current date and time for the internal clock.

Scheduling

This function allows up to 7 different scheduled activation intervals to be programmed for this Display.

You can set:

- The input source that will be used by the Display for each scheduled activation period.
- The time the Display will come on and go off.
- The days the Display will activate over one week.

Notes

- We recommend that the current date and time be set in {Clock} before using this function.
- After changing the {Clock} option in the {General Settings} menu, you need to set {Scheduling} again.

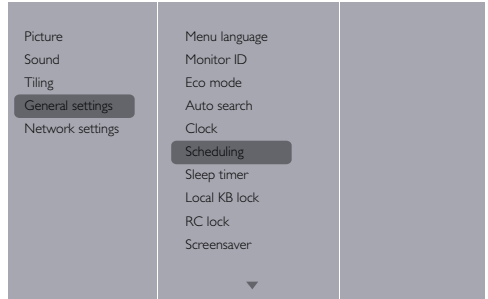

1. Seven schedules can be set. Go to **Status** and choose **On**.

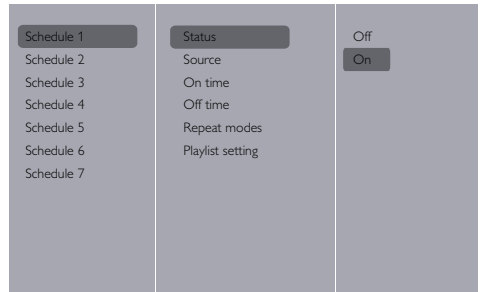

2. Go to **Source** and choose input source. If {Source} → {USB} is chosen. You need to set

playlist.

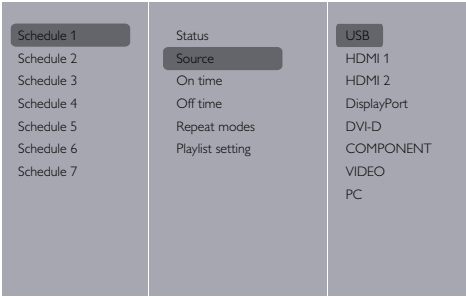

3. Set **On time**.

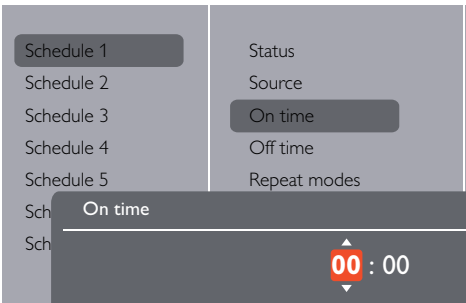

4. Set **Off time**.

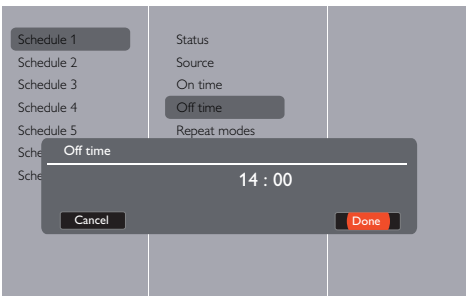

5. Go to **Repeat modes** and choose.

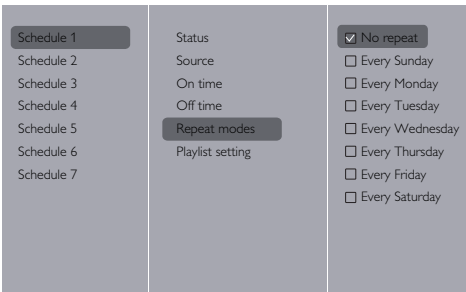

6. If {Source} → {USB} is chosen. Go to **Playlist setting**.

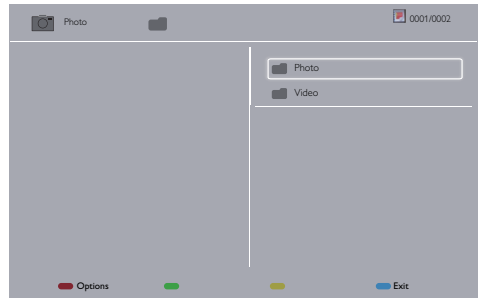

- Press **[Up] [Down]** to choose files.
 - Press **[Left] [Right]** to switch Playlist and File Manager.
 - Press **[OK]** to set or clear the playlist.
7. To save the playlist, Press **[Red]** and choose **Save list**.

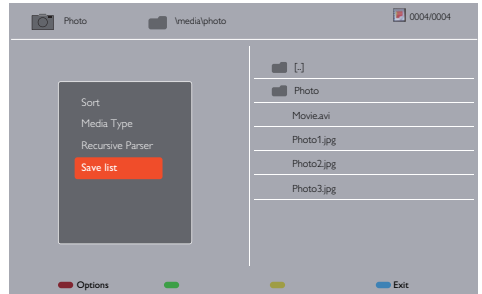

Notes

- Each Playlist supports up to 30 files.
- Playlist will not be cleared by {Factory settings}. Files must be manually removed or `usb_schedulinglist.txt` in USB must be deleted.

Sleep timer

Switch off this display after a specified time.

Auto adjust

Use this function to automatically optimize the display of images input from the PC.

Note

- This item functions for PC input only.

Local KB lock

Choose to enable or disable the keyboard (control buttons) function of the Display.

- {Unlock}: Enable the keyboard function.
- {Lock all}: Lock all keyboard function.
- {Lock volume}: Disable all the keyboard function except the **[Left]** and **[Right]** buttons.
- {Lock power}: Disable all keyboard functions except the **[POWER]** button.

- {Lock all except volume and power}: Disable all keyboard functions except the **[—]**, **[+]** and **[POWER]** buttons:

RC lock

Choose to enable or disable the button function of the remote control.

- {Unlock}: Enable keyboard functions.
- {Lock all}: Lock all keyboard functions.
- {Lock volume}: Disable all keyboard functions except the **[—]** and **[+]** buttons.
- {Lock power}: Disable all keyboard functions except the **[POWER]** button.
- {Lock all except volume and power}: Disable all keyboard functions except the **[—]** **[+]** and **[POWER]** buttons:

Note

- To disable the lock function from

Local KB lock or **-RC lock** press **[MENU]** and **1 9 9 8** on the remote control.

Screensaver

Alleviate the occurrence of afterimage when displaying still images or images with 4:3 aspect ratio for a long time.

- Screensaver operation
While the screensaver is operating, the following 5 patterns are displayed on the entire screen in turn every 5 seconds, and repeated.
Black → Dark gray → Gray → Light gray → White → Light gray → Gray → Dark gray
- Screensaver setting
{Mode} - {Off}: Stop the screensaver operation
{Mode} - {On}: Select {Start} and press <ENTER> on the remote control to start the screensaver.
{Mode} - {Time designation}: Set {Start time} and {Finish time}.

Attention

- When using this function, be sure to set the date and time on the {Clock} menu.
- Set this function after setting the date and time on the {Clock} menu.

Notes

- If the following buttons are pressed while the screensaver is operating, the screensaver is canceled.
- Remote control: <RETURN>
- Main unit: <MUTE>, <INPUT>, <+>, <->, <▲>, <▼>, <MENU>
- Turn "Off" the power of the display.
- The screensaver does not operate while the USB input is being displayed. If the input is switched to the USB input while the screensaver is operating, the screensaver operation is finished. (The same applies when switched to the USB input by {Scheduling}, {Failover/Failback} or external control commands as well.)

Pixel shift

With a video input source you can choose {On} to move the screen image automatically to protect the Display from "burn-in" or "after-image" effects after every 30 seconds of static display.

Smart power

Choose a backlight level to optimize dynamic power consumption and picture contrast.

The options are: {Off}, {Standard}, {Best Power}, {Best Picture}.

Wake on Lan

Choose {On} to turn on the Display through the network.

Switch on state

Choose the Display status to be used the next time the power cord is connected.

- {On} - The Display will turn on when the power cord is connected to a power outlet.
- {Standby} - The Display will remain in standby when the power cord is connected to a power outlet.
- {Last status} - The Display will return to the previous power status (on/off/standby) when the power cord is removed or replaced.

LED

Choose {Off} to turn off the indicator.

Switch on delay

Adjust the power-on delay time (in seconds) to allow sequential power-on for each Display when multiple Displays are connected.

APM

Choose {On}. Then the Display will automatically turn off when there is no signal.

Information OSD

The information OSD will be displayed in the upper left corner of the screen when **[POWER]** is pressed to turn the Display on from standby, or to change the input signal.

Choose {Off} to turn this function off.

DisplayPort Ver.:

Set the DisplayPort version to 1.1a or 1.2, this setting is only valid on DisplayPort input and output,

1.1a: Switch DisplayPort Ver. to 1.1a(default), DisplayPort output is a clone of DisplayPort input.

1.2: Switch DisplayPort Ver. to 1.2 to support MST (Multi-Stream Transport)

Note

- If the Display screen is black or abnormal under DisplayPort source, please switch to 1.1a and turn the AC power off and on again.

Serial response (ID all)

When "On" is selected, the response will be, receiving ID all (ID:000) using the serial command. (⇒ See page 23-24)

Notes

- ID:000 is the simultaneous transmission command (ID all command) to all the Displays.
- When using the Monitors in serial daisy chain, use commands with ID. When using the ID all command (ID:000), set only the last Display to "On".

Factory settings

Reset all your customized settings to the factory default.

Note

- Menu language, Monitor ID and Eco mode setting values are not reset.

Network settings

1. Press the [] HOME button, choose **Network settings** and press [].

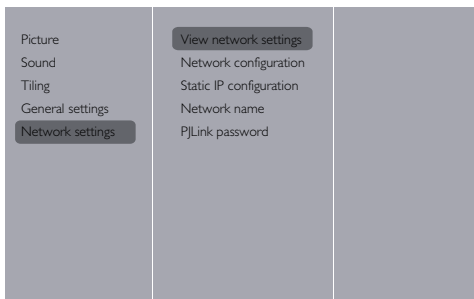

View network settings

View connected network status.

Network Configuration

{Network Configuration}: Choose how this Display should assign addresses to the network resources. The choice is between {DHCP & Auto IP} (recommended) and {Static IP}.

Static IP Configuration

Define {IP address}, {Netmask}, {Gateway}, {DNS1}, and {DNS2} for this Display If {Network settings} → {Static IP} has been chosen.

Network name

In a multiple-Display connection, each Display can be named for easy identification.

Use the on-screen keyboard or the remote control keypad to enter the name.

PLink password

Set the password for PLink security authentication.

- With the menu screen hidden, press the remote control buttons in this order "↑", "→", "↓", "←" and "RETURN" to display.
- Enter passwords in this order "current password", "New password" and "New password (Repeat)".
- When the remote control "ENTER" key is pressed at the password input field of each menu, the on-screen

keyboard will be displayed for input.

For password details, see "PLink protocol" (⇒ pages 36-38).

Using the Network Function

This unit has a network function and you can control a Display connected to the network using your computer.

The environment necessary for a computer connection

First of all, confirm whether your computer has a wired LAN.

Check the following settings before connecting the Display to the computer.

Check 1: The LAN cable

- Connect the cable properly.
- Use a category 5 compatible LAN cable.

Check 2: Wired LAN settings

Computer with a built-in wired LAN function

- Switch on the wired LAN.

Computer without a built-in wired LAN function

- Check that the LAN adapter has been recognized and it is switched on.
- Install the wired LAN adapter driver beforehand.
Refer to the LAN adapter manual for driver installation details.

Example of network connection

Note

- To use the network function, set each item in [Network settings] and make sure to set [Network control] to [On].

When it is set to [On], the power indicator light will be orange under the power "Off" condition in the remote control (stand-by state).

LAN Terminal connection

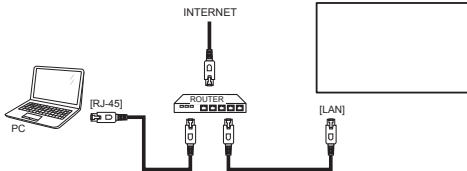

- Press the **[MENU]** button, choose <Network settings> and Press **[ENTER]**.
- Make the network setting according to details obtained from your System Administrator.

Notes

- Use a shielded LAN cable to prevent the occurrence of noise.
- Make sure the broadband router or hub supports 10BASE-T/100BASE-TX.
- Avoid touching the LAN terminal with your hands or body. A static discharge could damage the electronics.

Do not touch the LAN terminal or the metal part of the LAN cable.

- Consult your system administrator for instructions on making the LAN connections.

Computer operation

- Turn on the computer.
- Consult your system administrator for instructions on making the Network settings.

When the display settings are the default settings

Network configuration : Static IP

Static IP configuration.

IP address	192.168.0.8
Subnet mask	255.255.255.0
Gateway	192.168.0.1

The computer can be used with the following network settings.

IP address	192.168.0.9
Subnet mask	255.255.255.0
Gateway	192.168.0.1

PJLink protocol

The Network function of the unit is compatible with PJLink Class 1. The following operations can be performed from the computer using the PJLink protocol.

- Setting the Display
- Querying the Display status

Notes

- Set "Eco mode" to "Normal" when using the PJLink protocol. (⇒ See page 31)
- Set "Eco mode" to "Normal" when using Multi Monitoring & Control. (⇒ See page 31)

Supported commands

The commands used to control the unit with PJLink protocol are as follows.

Command	Control
POWR	Power control 0: Standby 1: Power On
POWR?	Power status query 0: Standby 1: Power On
INPT	Input switch 11: PC IN input (PC) 21: COMPONENT input (COMPONENT) 22: VIDEO input (VIDEO) 31: HDMI 1 input (HDMI1) 32: HDMI 2 input (HDMI2) 33: DisplayPort IN input (DisplayPort) 34: DVI-D IN input (DVI-D) 41: USB input (USB)
INPT?	Input switch query 11: PC IN input (PC) 21: COMPONENT input (COMPONENT) 22: VIDEO input (VIDEO) 31: HDMI 1 input (HDMI1) 32: HDMI 2 input (HDMI2) 33: DisplayPort IN input (DisplayPort) 34: DVI-D IN input (DVI-D) 41: USB input (USB)

Command	Control
AVMT	Shutter control 10: Picture On (picture Off deactivated) 11: Picture Off (picture off) 20: Audio On (audio Mute deactivated) 21: Audio Off (audio muted) 30: Shutter mode Off (picture Off and audio Mute deactivated) 31: Shutter mode On (picture off and audio muted)
AVMT?	Shutter control query 11: Picture Off (picture off) 21: Audio Off (audio muted) 30: Shutter mode Off (picture Off and audio Mute deactivated) 31: Shutter mode On (picture off and audio muted)
ERST?	Error status query First byte: 0 Second byte: 0 Third byte: Temperature. 0, 1, or 2. • Meaning of 0, 1, or 2. 0: Error not detected, 1: Warning 2: Error Fourth byte: 0 Fifth byte: 0 Sixth byte: 0
LAMP?	Lamp status query Not supported

Command	Control
INST?	Input switch list query 11: PC IN input (PC) 21: COMPONENT input (COMPONENT) 22: VIDEO input (VIDEO) 31: HDMI 1 input (HDMI1) 32: HDMI 2 input (HDMI2) 33: DisplayPort IN input (DisplayPort) 34: DVI-D IN input (DVI-D) 41: USB input (USB)
NAME?	The name selected in [Network settings] - [Network name] is returned.
INF1?	Manufacturer name query Returns "Panasonic".
INF2?	Model name query Case by 55LFV9U, return "55LFV9U" Case by 55LFV9W, return "55LFV9W"
INFO?	Other information query Returns version number.
CLSS?	Class information query Returns "1".

Note

Refer to the following table for error responses during communication.

Error message
"ERR1" : Undefined control command
"ERR2" : Out of parameter range
"ERR3" : Busy status or reception invalid period
"ERR4" : Display failure

- Do not send the PJLink command and RS232C command simultaneously. The RS232C command cannot be received while the PJLink command is being processed. Also, no response is returned to the RS232C command.

Notes

- When some of the commands, a part of a character string of the transmitted data may not be included in the received data.
- Consult your local Panasonic dealer for detailed instructions on command usage.

Visit the following website for details.

<https://panasonic.net/prodisplays/>

PJLink security authentication

Use a password for PJLink security authentication.

- The default password is shown below.

@Panasonic

Change the password first.

- The password can be changed on the "PJLink password" setting screen. (⇒ See page 34)
- Factory settings will restore the password to the factory default.
- The maximum number of characters that can be used for a password is 16 characters.
- Recommended password

Number of characters: 8 to 16

Include at least 3 types of character from the following.

- Alphabet uppercase character (A-Z)
- Alphabet lowercase character (a-z)
- Number (0-9)
- Special character (! @ # \$ % etc)

When using without authentication, leave the password blank.

Should any of the following points apply, a warning message will be displayed.

- When the password does not satisfy the recommended conditions.
- When the default password has not been changed
- When the new password is the same as the old one
- No password (blank)

Notes

- It is recommended that do not set the same password as the current password or the same value as the factory setting as the New password.
- For PJLink specifications, visit the Japan Business Machine and Information System Industries Association (JBMIA) website: <http://pjlink.jbmia.or.jp/english/index.html>
- No member of the Panasonic Connect Co., Ltd. or its affiliate companies will ever ask directly for your password new
Never divulge your password should you ever receive such a request.

Multi Monitoring & Control Software

This unit supports the early warning software "Multi Monitoring & Control Software" which monitors and controls devices (projectors or displays) connected to an intranet, and detects signs of abnormality of such devices that may arise in future. As for the early warning function, the maximum number of devices that can be registered to monitor differs according to the type of license. Up to 2 048 devices can be registered for free for a maximum of 90 days after the installation to the computer has completed.

- For more details, visit the following web site.
<https://panasonic.net/cns/prodisplays/>
- About early warning function, visit the following web site.
<https://panasonic.net/cns/prodisplays/pass/>

USB device compatibility

USB Video Subtitle Formats (for language subtitles, etc.)

File Extensions	Container	Video codec	Maximum resolution	Max. Frame Rate (fps)	Max. Bit Rate (Mbps)	Audio codec
.mpg .mpeg .vob	PS	MPEG-1	1920x1080	25p,30p,50i,60i	30	MPEG-1(L1&L2), MPEG-1,2,2.5 L3, AAC/HE- AAC(v1&v2), DVD-PCM,AC3
		MPEG-2	1920x1080	25p,30p,50i,60i	30	
		MPEG-4 ASP	1920x1080	25p,30p,50i,60i	30	
		H.264	1920x1080	25p,30p,50p,60p,60i	30	
.ts	TS	MPEG-2	1920x1080	25p,30p,50i,60i	30	MPEG-1(L1&L2), MPEG-1,2,2.5 L3, AAC/HE-AAC (v1&v2), AC3,E-AC3, Dolby Pulse
		MPEG-4 ASP	1920x1080	25p,30p,50i,60i	30	
		H.264	1920x1080	25p,30p,50p,60p,60i	30	
		MVC	1920x1080i@field rate=50, 60Hz 1920x1080p@frame rate=24, 25,30Hz 1280x720p@frame rate=50, 60Hz	-	30	
.ts .m2ts .mts .mt2	MaTS TTS	MPEG-2	1920x1080	25p,30p,50i,60i	30	MPEG-1(L1&L2), MPEG-1,2,2.5 L3, AAC/HE-AAC (v1&v2), AC3,E-AC3, Dolby Pulse
		MPEG-4 ASP	1920x1080	25p,30p,50i,60i	30	
		H.264	1920x1080	25p,30p,50p,60p,60i	30	
		MVC	1920x1080i @ field rate=50, 60Hz 1920x1080p @ frame rate=24, 25,30Hz 1280x720p @ frame rate=50, 60Hz	-	30	
.ts .m2ts .mts	AVCHD	MPEG-2	1920x1080	25p,30p,50i,60i	30	MPEG-1(L1&L2), MPEG-1,2,2.5 L3, AAC/HE-AAC (v1&v2), AC3,E-AC3, Dolby Pulse
		MPEG-4 ASP	1920x1080	25p,30p,50i,60i	30	
		H.264	1920x1080	25p,30p,50p,60p,60i	30	
.ts .m2ts .mts	AVCHD	MVC	1920x1080i@field rate=50, 60Hz 1920x1080p@frame rate=24, 25,30Hz 1280x720p @ frame rate=50, 60Hz	-	30	MPEG-1(L1&L2), MPEG-1,2,2.5 L3, AAC/HE-AAC (v1&v2), AC3,E-AC3, Dolby Pulse
.m4v	M4V	H.264	1920x1080	25p,30p,50p,60p,60i	30	AAC

.ism/ Manifest .mpd	frag MP4	H.264	1920x1080	25p,30p,50p,60p,60i	30	AAC/HE- AAC(v1&v2), AC3,E-AC3,WMA, WMA-PRO
		MVC	1920x1080i@field rate=50, 60Hz 1920x1080p@frame rate=24, 25,30Hz 1280x720p @ frame rate=50, 60Hz	-	30	
.mp4	MP4	MPEG-4 ASP	1920x1080	25p,30p,50i,60i	30	AAC/HE-AAC(v1&v2), AC3,E-AC3,WMA, WMA-PRO
		H.264	1920x1080		30	
		MVC	1920x1080i@field rate=50, 60Hz 1920x1080p@frame rate=24, 25,30Hz 1280x720p @ frame rate=50, 60Hz	-	30	
		WMV9/VC1	1920x1080	30p,60i	30	
.mkv .mk3d	MKV	MPEG-4 ASP	1920x1080	25p,30p,50i,60i	30	MPEG-1(L1&L2), MPEG-1,2,2.5 L3, AAC/HE-AAC (v1&v2), AC3,E-AC3, WMA, WMA-PRO
		H.264	1920x1080		30	

USB still image Formats

File Extensions	Video codec	Maximum resolution
jpg/jpeg	JPEG	Color mode 444: 32768 x 16128 or less Color mode 422: 16384 x 16128 or less
bmp	BMP	4096 x 3072 / 4bit
png	PNG	2730 x 2500 / 8bit
gif	GIF	2048 x 1536 / 16bit 1500 x 1200 / 32bit

USB Multimedia Formats

File Extensions	Container	Video codec	Maximum resolution	Frequency (kHz)	Max. Bit Rate (kbps)	Audio codec
.mp3	MP3	-	-	48	384	MPEG-1,2,2.5 L3
.wma .asf	WMA (V2 up to V9.2)	-	-	48	192	WMA
.wma	WMA Pro	-	-	96	768	WMA,WMA Pro
.wav(PC)	LPCM	-	-	192	768	LPCM
.aif(mac) .aiff(mac)	LPCM	-	-	192	768	LPCM
.aac .mp4 .m4a	AAC	-	-	48	1024	AAC,HE-AAC(v1&v2)
.pls .m3u	Playlists	-	-	-	-	-
.m4a	M4A	-	-	48	1024	AAC,HE-AAC(v1&v2)

Notes

- Sound or video may not work if the content has a standard bit rate/frame rate above the compatible Frame/sec listed in the table above.
- Video content with a Bit rate or Frame rate higher than the rate specified in the table above can cause choppy video playback.

Input Mode

VGA Resolution:

Standard Resolution	Active Resolution		Refresh Rate	Pixel Rate	Aspect Ratio	Stand for Mode
	H Pixels	V Lines				
VGA	640	480	60 Hz	25.175 MHz	4:3	Video Graphic Array
			72 Hz	31.5 MHz		
			75 Hz	31.5 MHz		
WVGA	720	400	70 Hz	33.75 MHz	16:9	Wide Video Graphic Array
SVGA	800	600	60 Hz	40 MHz	4:3	Super VGA
			75 Hz	49.5 MHz		
XGA	1024	768	60 Hz	65 MHz	4:3	Extended Graphic Array
			75 Hz	78.75 MHz		
WXGA	1280	768	60 Hz	79.5 MHz	5:3	Wide XGA
WXGA	1280	800	60 Hz	79.5 MHz	16:10	Wide XGA
SXGA	1280	1024	60 Hz	108 MHz	5:4	Super XGA
WXGA	1360	768	60 Hz	85.5 MHz	16:9	Wide XGA
WXGA	1366	768	60 Hz	85.5 MHz	16:9	Wide XGA
UXGA	1600	1200	60 Hz	162 MHz	4:3	Ultra XGA
HD1080	1920	1080	60 Hz	148.5 MHz	16:9	HD1080

SDTV Resolution:

Standard Resolution	Active Resolution		Refresh Rate	Pixel Rate	Aspect Ratio	Stand for Mode
	H Pixels	V Lines				
480i	720	480	29.97 Hz	13.5 MHz	4:3	Modified NTSC Standard
480p			59.94 Hz	27 MHz		
576i	720	576	25 Hz	13.5 MHz	4:3	Modified PAL Standard
576p			50 Hz	27 MHz		

HDTV Resolution:

Standard Resolution	Active Resolution		Refresh Rate	Pixel Rate	Aspect Ratio	Stand for Mode
	H Pixels	V Lines				
720p	1280	720	50 Hz	74.25 MHz	16:9	Normally DVB Mode
			60 Hz			
1080i	1920	1080	25 Hz	74.25 MHz	16:9	Normally ATSC Mode
			30 Hz			
1080p	1920	1080	50 Hz	148.5 MHz	16:9	Normally ATSC Mode
			60 Hz			

4K Resolution:

Standard Resolution	Active Resolution		Refresh Rate	Pixel Rate	Aspect Ratio	Stand for Mode
	H Pixels	V Lines				
QFHD	3840	2160	30 Hz	297MHz	16:9	-

- The optimum PC text quality is provided by HD 1080 mode (1920 x 1080, 60Hz).
- Your PC Display screen might appear different depending on the manufacturer (and your particular version of Windows).
- Check your PC instruction book for information about connecting your PC to a Display.
- If your PC offers vertical and horizontal frequency selection, choose 60Hz (vertical) and 31.5KHz (horizontal). In some cases, abnormal signals (such as stripes) might appear on the screen when the PC power is turned off, or disconnected. If so, press the [INPUT] button to enter the video mode. Also, make sure that the PC is connected.
- If the horizontal synchronous signals seem irregular in the RGB mode, check the PC power saving mode or cable connections.
- The Display settings table complies with the IBM/VESA standards, and is based on analogue input.
- The DVI support mode is the same as the PC support mode.
- The best vertical frequency timing for both modes is 60Hz.

Troubleshooting

Troubleshooting

Symptom	Possible Cause	Remedy
No picture is displayed	<ol style="list-style-type: none"> 1. The power cord is disconnected. 2. The main power switch on the back of the Display is not switched on. 3. The selected input has no connection. 4. The Display is in standby mode. 	<ol style="list-style-type: none"> 1. Plug in the power cord. 2. Make sure the power switch is on. 3. Connect a signal source to the Display.
There is interference on the Display or audible noise.	Caused by surrounding electrical appliances or fluorescent lights.	Check for the source of interference by moving the display to another location.
Colour is abnormal	The signal cable is not connected properly.	Make sure that the signal cable at the back of the Display is attached firmly.
Picture is distorted and has abnormal patterns	<ol style="list-style-type: none"> 1. The signal cable is not connected properly. 2. The input signal exceeds the capabilities of the Display. 	<ol style="list-style-type: none"> 1. Make sure that the signal cable is attached firmly. 2. Check the video signal source to see if it is beyond the range of the Display. Please check the signal compatibility with the details in the Display specification section.
Sound is audible, but there is no picture.	Source signal cable is not connected properly.	Make sure that both the video and sound inputs are connected correctly.
Picture is present, but there is no sound.	<ol style="list-style-type: none"> 1. Source signal cable is not connected properly. 2. Volume is turned all the way down. 3. {Mute} is turned on. 4. No external speaker connected. 	<ol style="list-style-type: none"> 1. Make sure that both video and sound inputs are correctly connected. 2. Press the [+] or [-] button. 3. Switch MUTE off with the [MUTE] button. 4. Connect external speakers and adjust the volume to a suitable level.
Some picture elements do not light up.	Some pixels on the Display may not turn on.	This Display is manufactured using an extremely high level of precision technology; however, sometimes a very few inactive pixels may be present. This is not a malfunction.
After-Images can be seen on the Display after it has been turned off. (Examples of still pictures include logos, video games, computer images, and images displayed in 4:3 normal mode)	A still picture is displayed for an extended period of time.	Do not allow a still image to be displayed for very long periods of time. This can cause a permanent after-image that remains on the Display.

Control from the external device not possible.	Cable not connected to SERIAL or LAN terminal. The network setting is incorrect.	Confirm that the cable is properly connected. Confirm that the network setting is correct.
--	---	---

Technical Specifications

Display:

Item	Specifications
Screen Size (Active Area)	54.6" (138.7 cm) LCD
Aspect Ratio	16:9
Number of pixels	1 920 (H) x 1 080 (V)
Pixel pitch	0.630 (H) x 0.630 (V) [mm]
Brightness (typical)	500 cd/m ²
Contrast ratio (typical)	1 200:1
Viewing angle	178 degrees

In/Out Terminals:

Item		Specifications
Speaker Output	External Speakers	10W(L) + 10W(R) [RMS] / 8Ω
Audio Output	3.5mm stereo mini jack x 1	0.5V [rms] (Normal) / 2 Channel (L+R)
Audio Input	Pin jack x 2 3.5mm stereo mini jack x 1	0.5V [rms] (Normal) / 2 Channel (L+R)
SERIAL Input/ Output	2.5mm stereo mini jack x 2	RS232C input / RS232C output
LAN	RJ-45 socket x 1 (8 pin)	10/100 LAN Port
HDMI Input	HDMI socket x 2 (Type A) (18 pin)	Digital RGB: TMDS (Video + Audio) MAX: Video - 720p, 1080p, 1920 x 1080/60 Hz Audio - 48 KHz/ 2 Channel (L+R) Supports LPCM only
DVI-D Input	DVI-D socket	Digital RGB: TMDS (Video)
PC Input	D-Sub Jack x 1 (15 pin)	Analogue RGB: 0.7V [p-p] (75Ω), H/CS/V: TTL (2.2kΩ), SOG: 1V [p-p] (75Ω) MAX: 720p, 1080p, 1920 x 1080/60 Hz
DVI-I (DVI-D & PC) Output	DVI-I socket x 1 (29 pin)	Digital RGB: TMDS (Video) Analogue RGB: 0.7V [p-p] (75Ω), H/CS/V: TTL (2.2kΩ), SOG: 1V [p-p] (75Ω) MAX: 720p, 1080p, 1920 x 1080/60 Hz
Component Input	BNC socket x 3	Y: 1V [p-p] (75Ω), Pb: 0.7V [p-p] (75Ω), Pr: 0.7V [p-p] (75Ω) MAX: 480i, 576i, 480p, 576p, 720p, 1080i, 1080p
Video Input	BNC x 1 (Share with Component_Y)	Composite 1V [p-p] (75Ω)
DisplayPort in/out	DisplayPort socket x 2 (20 pin)	Digital RGB: TMDS (Video + Audio) MAX: Video - 720p, 1080p, 1920 x 1080/60 Hz, 3840 x 2160/30 Hz (QFHD) Audio - 48 KHz/ 2 Channel (L+R) Supports LPCM only

General:

Item	Specifications
Power Supply	TH-55LFV9U: 110 - 127V 50 / 60 Hz TH-55LFV9W: 220 - 240V 50 / 60 Hz
Power Consumption (Max)	185 W
Power Consumption (Standby & Off)	<0.5 W (RS232 active, Eco mode: low power standby) / 0 W
Dimensions (Without Stand) [W x H x D] (mm)	1 213.4 x 684.2 x 98.0
Weight (Without Stand)	27 Kg

Environmental Conditions:

Item		Specifications
Temperature	Operational	0 ~ 40°C * Environmental temperature to use this unit at high altitudes (1400m(4593ft) and higher and below 2800m(9186ft) above sea level) : 0°C to 35°C (32°F to 95°F)
	Storage	-20 ~ 60°C
Humidity	Operational	20 ~ 80% RH (No condensation)
	Storage	5 ~ 95% RH (No condensation)
Altitude	Operational	0 ~ 2,800 m
	Storage / Shipment	0 ~ 9,000 m

Disposal of Old Equipment and Batteries

Only for European Union and countries with recycling systems



These symbols on the products, packaging, and/or accompanying documents mean that used electrical and electronic products and batteries must not be mixed with general household waste.

For proper treatment, recovery and recycling of old products and used batteries, please take them to applicable collection points in accordance with your national legislation.

By disposing of them correctly, you will help to save valuable resources and prevent any potential negative effects on human health and the environment.

For more information about collection and recycling, please contact your local authority.

Penalties may be applicable for incorrect disposal of this waste, in accordance with national legislation.



Note for the battery symbol (bottom symbol)

This symbol might be used in combination with a chemical symbol. In this case it complies with the requirement set by the Directive for the chemical involved.

Notice (USA only)

Disposal may be regulated in your community for environmental considerations. For information about disposal or recycling, please visit the Panasonic website: <https://www.panasonic.com/us/corporate/sustainability.html> or call 1-888-769-0149.

Customer's Record

The model and serial numbers of this product may be found on the rear panel. You should write the serial number in the space provided below and keep this book in a safe place with your purchase receipt, as a permanent record and as an aid in identification in the event of theft or loss, as well as for Warranty Service purposes.

Model Number

Serial Number

For TH-55LFV9U

Panasonic Connect North America

Unit of Panasonic Corporation of North America

Executive Office:

Two Riverfront Plaza, Newark, New Jersey 07102

Panasonic Canada Inc.

5770 Ambler Drive

Mississauga, Ontario

L4W 2T3

For TH-55LFV9W

Authorized Representative in EU:

Panasonic Connect Europe GmbH

Panasonic Testing Centre

Winsbergring 15, 22525 Hamburg, Germany

Importer for UK:

Panasonic Connect UK,

a branch of Panasonic Connect Europe GmbH,

Maxis 2, Western Road, Bracknell, Berkshire, RG12 1RT

Panasonic Connect Co., Ltd.

4-1-62 Minoshima, Hakata-ku, Fukuoka 812-8531, Japan

Web Site: <https://panasonic.net/cns/prodisplays/>

© Panasonic Connect Co., Ltd. 2022

English

Printed in China