

# Panasonic®

## Operating Instructions Functional Manual

UHD LCD Display For business use

Model No.	TH-86EQ3W	86-inch model
	TH-75EQ3W	75-inch model
	TH-65EQ3W	65-inch model
	TH-55EQ3W	55-inch model
	TH-50EQ3W	50-inch model
	TH-43EQ3W	43-inch model

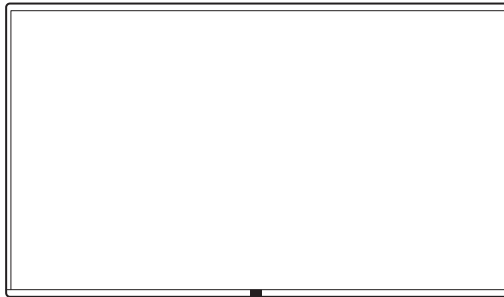

**4K**  
PROFESSIONAL

\*Actual resolution: 3840 × 2160p

**HDMI™**

**HE** Advance™  
Covered by patents at [patentlist.access.panasonic.com](http://patentlist.access.panasonic.com)

\* This manual is common to all the models regardless of suffixes of the model number.

English

Please read these instructions before operating your set and retain them for future reference.



## Dear Panasonic Customer

Welcome to the Panasonic family of customers. We hope that you will have many years of enjoyment from your new UHD LCD Display.

To obtain maximum benefit from your set, please read these Instructions before making any adjustments, and retain them for future reference.

Retain your purchase receipt also, and note down the model number and serial number of your set in the space provided on the rear cover of these instructions.

Visit our Panasonic Web Site

<https://docs.connect.panasonic.com/prodisplays>

## Table of Contents

---

### Before use

- Illustrations and screens in this Operating Instructions are images for illustration purposes, and may be different from the actual ones.
  - Descriptive illustrations in this Operating Instructions are created mainly based on the 55-inch model.
- 

<b>Important Safety Instructions</b> .....	<b>4</b>
<b>FCC STATEMENT</b> .....	<b>5</b>
<b>Important Safety Notice</b> .....	<b>6</b>
<b>Safety Precautions</b> .....	<b>8</b>
<b>Precautions for use</b> .....	<b>11</b>
<b>Accessories</b> .....	<b>14</b>
Accessories Supply .....	14
Remote Control Batteries .....	15
<b>Cautions when moving</b> .....	<b>15</b>
<b>Kensington security</b> .....	<b>16</b>
<b>Eyebolt</b> .....	<b>16</b>
<b>Connections</b> .....	<b>18</b>
AC cord connection and fixing / Cable fixing .....	18
Video equipment connection .....	20
Before connecting .....	21
HDMI IN 1, HDMI IN 2 and HDMI IN 3 terminals connection .....	21
PC IN terminal connection .....	22
RS232 terminal connection .....	23
AUDIO OUT terminal connection .....	25
USB terminal connection .....	25
<b>Identifying Controls</b> .....	<b>27</b>
Display .....	27
Remote Control Transmitter .....	28
<b>Basic Controls</b> .....	<b>29</b>
Selecting the input signal .....	30
Confirming the input signal, screen mode, etc. ....	31
Volume Adjustment .....	31
Sound mute On / Off.....	31

<b>ASPECT Controls</b> .....	<b>32</b>
<b>On-Screen Menu Displays</b> .....	<b>33</b>
<b>Picture Adjustments</b> .....	<b>35</b>
<b>Sound Adjustment</b> .....	<b>36</b>
<b>Setup menu</b> .....	<b>37</b>
Language .....	37
Date and time .....	37
Setup Timer .....	37
Network settings .....	38
HDMI-CEC control .....	40
PressIT settings.....	40
EDID select .....	41
Position .....	41
Power save mode .....	42
Power Management .....	42
Auto play(USB) .....	42
Button lock .....	42
RC control lock.....	43
Front indicator light.....	43
Quick start .....	43
Onscreen display .....	43
Multi display settings .....	43
Options .....	44
Information .....	44
All reset .....	44
<b>Using Network Function</b> .....	<b>45</b>
Necessary environment for computers to be connected .....	45
Example of network connection .....	45
Settings to connect to a LAN .....	46
Access from the web browser.....	46
Command control .....	50
Control Command via LAN .....	50
PjLink protocol.....	52
Multi Monitoring & Control Software.....	53
<b>Using “USB media file playback function” ...</b>	<b>54</b>
Play file.....	55
Auto playback .....	55
Playing the pictures .....	56
Playing the music / video .....	57
<b>Using HDMI-CEC function</b> .....	<b>58</b>
Connection .....	58
Setting .....	58
<b>Using data cloning</b> .....	<b>58</b>
Copying the display data to the USB memory .....	58
Copying (cloning) the USB memory data to the display .....	59
Changing the cloning password .....	60
<b>Software on this unit</b> .....	<b>60</b>
<b>Preset Signals</b> .....	<b>61</b>
<b>Troubleshooting</b> .....	<b>63</b>
<b>Specifications</b> .....	<b>65</b>
<b>Software License</b> .....	<b>68</b>

# Important Safety Instructions



**WARNING: To reduce the risk of electric shock, do not remove cover or back.**

**No user-serviceable parts inside. Refer servicing to qualified service personnel.**



The lightning flash with arrow-head within a triangle is intended to tell the user that parts inside the product are a risk of electric shock to persons.



The exclamation point within a triangle is intended to tell the user that important operating and servicing instructions are in the papers with the appliance.

## WARNING:

**To prevent damage which may result in fire or shock hazard, do not expose this apparatus to rain or moisture.**

**Do not place containers with water (flower vase, cups, cosmetics, etc.) above the set. (including on shelves above, etc.)**

## WARNING:

- 1) To prevent electric shock, do not remove cover. No user serviceable parts inside. Refer servicing to qualified service personnel.
- 2) Do not remove the grounding pin on the power plug. This apparatus is equipped with a three pin grounding-type power plug. This plug will only fit a grounding-type power outlet. This is a safety feature. If you are unable to insert the plug into the outlet, contact an electrician.

Do not defeat the purpose of the grounding plug.

## WARNING: THIS PRODUCT CONTAINS A COIN BATTERY



- **INGESTION HAZARD:** This product contains a button cell or coin battery.
- **DEATH** or serious injury can occur in 2 hours or less if swallowed or placed inside any part of the body.
- The battery is hazardous, **KEEP** new and used batteries **OUT OF REACH** of **CHILDREN**
- Seek immediate medical attention if a battery is suspected to be swallowed or inserted inside any part of the body.

- 1) Read these instructions.
- 2) Keep these instructions.
- 3) Heed all warnings.
- 4) Follow all instructions.
- 5) Do not use this apparatus near water.
- 6) Clean only with dry cloth.
- 7) Do not block any ventilation openings. Install in accordance with the manufacturer's instructions.
- 8) Do not install near any heat sources such as radiators, heat registers, stoves, or other apparatus (including amplifiers) that produce heat.
- 9) Do not defeat the safety purpose of the polarized or grounding-type plug. A polarized plug has two blades with one wider than the other. A grounding type plug has two blades and a third grounding prong. The wide blade or the third prong are provided for your safety. If the provided plug does not fit into your outlet, consult an electrician for replacement of the obsolete outlet.
- 10) Protect the power cord from being walked on or pinched particularly at plugs, convenience receptacles, and the point where they exit from the apparatus.
- 11) Only use attachments / accessories specified by the manufacturer.
- 12) Use only with the cart, stand, tripod, bracket, or table specified by the manufacturer, or sold with the apparatus. When a cart is used, use caution when moving the cart / apparatus combination to avoid injury from tip-over.
- 13) Unplug this apparatus during lightning storms or when unused for long periods of time.
- 14) Refer all servicing to qualified service personnel. Servicing is required when the apparatus has been damaged in any way, such as power-supply cord or plug is damaged, liquid has been spilled or objects have fallen into the apparatus, the apparatus has been exposed to rain or moisture, does not operate normally, or has been dropped.
- 15) To prevent electric shock, ensure the grounding pin on the AC cord power plug is securely connected.



# FCC STATEMENT

This equipment has been tested and found to comply with the limits for a class A digital device, pursuant to Part 15 of the FCC Rules. These limits are designed to provide reasonable protection against harmful interference when the equipment is operated in a commercial environment. This equipment generates, uses and can radiate radio frequency energy and, if not installed and used in accordance with the instructions manual, may cause harmful interference to radio communications. Operation of this equipment in a residential area is likely to cause harmful interference in which case the user will be required to correct the interference at his own expense.

## FCC CAUTION:

**To assure continued compliance, follow the attached installation instructions and use only the provided power supply cord. Any changes or modifications not expressly approved by Panasonic Corp. of North America could void the user's authority to operate this device.**

Supplier's Declaration of Conformity

Model No.

TH-86EQ3W, TH-75EQ3W, TH-65EQ3W,  
TH-55EQ3W, TH-50EQ3W, TH-43EQ3W

Responsible Party:

Panasonic Corporation of North America  
Two Riverfront Plaza, Newark, New Jersey  
07102-5490

Contact Source:

Panasonic Projector & Display Americas LLC  
1-855-772-8324

General Contact:

<http://shop.panasonic.com/support>

This device complies with Part 15 of the FCC Rules. Operation is subject to the following two conditions: (1) This device may not cause harmful interference, and (2) this device must accept any interference received, including interference that may cause undesired operation.

To maintain compliance with EMC regulations, use shielded cables to connect to the following terminals: HDMI input terminal, D-sub input terminal and RS-232C input terminal.

## CANADIAN NOTICE:

This Class A digital apparatus complies with Canadian ICES-003.

## WARNING:

- Not for use in a computer room as defined in the Standard for the Protection of Electronic Computer/ Data Processing Equipment, ANSI/NFPA 75.
- For permanently connected equipment, a readily accessible disconnect device shall be incorporated in the building installation wiring.
- For pluggable equipment, the socket-outlet shall be installed near the equipment and shall be easily accessible.

For USA-California Only

This product contains a CR Coin Cell Lithium Battery which contains Perchlorate Material - special handling may apply. See

[www.dtsc.ca.gov/hazardouswaste/perchlorate](http://www.dtsc.ca.gov/hazardouswaste/perchlorate)

For European Union Only



This CE mark covers the battery(ies) supplied with the product and indicates that the battery(ies) comply with the requirements of the Battery Regulation (EU) 2023/1542.

## Note:

Image retention may occur. If you display a still picture for an extended period, the image might remain on the screen. However, it will disappear when a general moving picture is displayed for a while.

## Trademark Credits

- PressIT is a trademark of Panasonic Projector & Display Corporation.
- Microsoft, Windows, Internet Explorer and Microsoft Edge are the registered trademarks or trademarks of Microsoft Corporation in the United States and/or other countries.
- Mac, macOS and Safari are the trademarks of Apple Inc. registered in the United States and other countries.
- PJLink is a registered or pending trademark in Japan, the United States, and other countries and regions.
- Users in the United States:  
Crestron®, Crestron Connected®, the Crestron Connected logo, and XiO Cloud® are either trademarks or registered trademarks of Crestron Electronics, Inc. in the United States and/or other countries.  
Crestron Connected® software is owned by Crestron Electronics, Inc. and is compatible with the Crestron XiO Cloud® Service.  
Users outside the United States:  
Crestron, Crestron Connected, the Crestron Connected logo, and XiO Cloud are either trademarks or registered trademarks of Crestron Electronics, Inc. in the United States and/or other countries.  
Crestron Connected software is owned by Crestron Electronics, Inc. and is compatible with the Crestron XiO Cloud Service.

# CRESTRON CONNECTED

- The terms HDMI, HDMI High-Definition Multimedia Interface, HDMI Trade dress and the HDMI Logos are trademarks or registered trademarks of HDMI Licensing Administrator, Inc.

Even if no special notation has been made of company or product trademarks, these trademarks have been fully respected.

# Important Safety Notice

## WARNING

- 1) To prevent damage which may result in fire or shock hazard, do not expose this appliance to dripping or splashing.  
Do not place containers with water (flower vase, cups, cosmetics, etc.) above the set. (including on shelves above, etc.)  
No naked flame sources, such as lighted candles, should be placed on / above the set.
- 2) To prevent electric shock, do not remove cover. No user serviceable parts inside. Refer servicing to qualified service personnel.
- 3) Do not remove the earthing pin on the power plug. This apparatus is equipped with a three pin earthing-type power plug. This plug will only fit an earthing-type power outlet. This is a safety feature. If you are unable to insert the plug into the outlet, contact an electrician.  
Do not defeat the purpose of the earthing plug.
- 4) To prevent electric shock, ensure the earthing pin on the AC cord power plug is securely connected.

## CAUTION

This appliance is intended for use in environments which are relatively free of electromagnetic fields.

Using this appliance near sources of strong electromagnetic fields or where electrical noise may overlap with the input signals could cause the picture and sound to wobble or cause interference such as noise to appear.

Using this appliance near sources of strong electromagnetic fields or where electrical noise may overlap with the input signals could cause the sensor function not to work correctly.

To avoid the possibility of harm to this appliance, keep it away from sources of strong electromagnetic fields.

## WARNING:

This equipment is compliant with Class A of EN55032/ CISPR32. In a residential environment this equipment may cause radio interference.

**IMPORTANT INFORMATION: Stability Hazard**

Never place a display in an unstable location. A display may fall, causing serious personal injury or death. Many injuries, particularly to children, can be avoided by taking simple precautions such as:

- Using cabinets or stands recommended by the manufacturer of the display.
- Only using furniture that can safely support the display.
- Ensuring the display is not overhanging the edge of the supporting furniture.
- Not placing the display on tall furniture (for example, cupboards or bookcases) without anchoring both the furniture and the display to a suitable support.
- Not placing the display on cloth or other materials that may be located between the display and supporting furniture.
- Educating children about the dangers of climbing on furniture to reach the display or its controls.

If the existing display is going to be retained and relocated, the same considerations as above should be applied.

**IMPORTANT: THE MOULDED PLUG FOR YOUR SAFETY, PLEASE READ THE FOLLOWING TEXT CAREFULLY.**

This display is supplied with a moulded three pin mains plug for your safety and convenience. A 10 amp fuse is fitted in this plug. Shall the fuse need to be replaced, please ensure that the replacement fuse has a rating of 10 amps and that it is approved by ASTA or BSI to BS1362.

Check for the ASTA mark  or the BSI mark  on the body of the fuse.

If the plug contains a removable fuse cover, you must ensure that it is refitted when the fuse is replaced.

If you lose the fuse cover the plug must not be used until a replacement cover is obtained.

A replacement fuse cover can be purchased from your local Panasonic dealer.

Do not cut off the mains plug.

Do not use any other type of mains lead except the one supplied with this display.

The supplied mains lead and moulded plug are designed to be used with this display to avoid interference and for your safety.

If the socket outlet in your home is not suitable, get it changed by a qualified electrician.

If the plug or mains lead becomes damaged, purchase a replacement from an authorized dealer.

**WARNING : — THIS DISPLAY MUST BE EARTHED**

**How to replace the fuse.**

Open the fuse compartment with a screwdriver and replace the fuse.

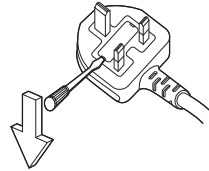

# Safety Precautions

## WARNING

### ■ Setup

**This LCD Display is for use only with the following optional accessories.**

**Use with any other type of optional accessories may cause instability which could result in the possibility of injury.**

**Securely install the pedestal and wall hanging bracket of the optional accessories. Ask an authorized dealer for installation.**

The following number of people are required for installation.

[ 86-inch model ] [ 75-inch model ] : 4 or more  
[ 65-inch model ] [ 55-inch model ] [ 50-inch model ]  
[ 43-inch model ] : 2 or more

#### • Pedestal

[ 75-inch model ] [ 65-inch model ] : TY-ST75PE9  
[ 55-inch model ] : TY-ST55PE9  
[ 50-inch model ] [ 43-inch model ] : TY-ST43PE9

#### • Wall hanging bracket\*

[ 86-inch model ] [ 75-inch model ] [ 65-inch model ] :  
TY-WK98PV1

\*: This product can be purchased in the U.S. and Japan.

#### Note

- The part number of the optional accessories are subject to change without notice.
- [ 86-inch model ] [ 75-inch model ] [ 65-inch model ] :  
When attaching the wall hanging bracket, be sure to remove the 2 lower handles.

When installing the pedestal or wall hanging bracket, read the operating instructions supplied with it carefully and install properly. Also, be sure to take a fall-prevention measure.

We are not responsible for any product damage, etc. caused by failures in the installation environment for the pedestal or wall hanging bracket even during the warranty period.

Small parts can present choking hazard if accidentally swallowed. Keep small parts away from young children. Discard unneeded small parts and other objects, including packaging materials and plastic bags/sheets to prevent them from being played with by young children, creating the potential risk of suffocation.

**Do not place the Display on sloped or unstable surfaces, and ensure that the Display does not hang over the edge of the base.**

- The Display may fall off or tip over.

**Install this unit at a location with minimal vibration and which can support the weight of the unit.**

- Dropping or falling of the unit may cause injury or malfunction.

**Caution - For use only with UL Listed Wall Mount Bracket with minimum weight/load, please refer to the Specifications. (see page 66)**

**When installing the display vertically, be sure that the power indicator comes to the upper side.**

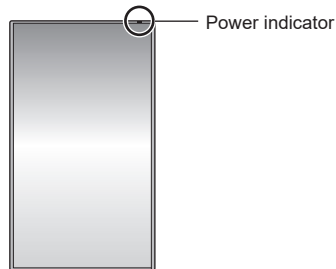

- If installed in different directions, heat is generated and it may cause fire or damage to the Display.

**When using this unit, be sure to take safety measures to prevent falling or dropping of the unit.**

- If an earthquake occurs or a child climbs the unit, the unit may fall or drop, resulting in an injury.

**Do not position the unit with its liquid crystal panel facing upright.**

- There are conditions of mounting method, environmental temperature, connections and settings. If installed in different conditions, heat is generated and it may cause fire or damage to the Display.

#### Cautions for Wall or Pedestal Installation

- The installation should be performed by an installation professional. Installing the Display incorrectly may lead to an accident that results in death or serious injury. Use the optional Pedestal. (see page 8)

- When installing on a wall, the specified wall hanging bracket (optional accessory) or a wall hanging bracket that conforms to VESA standards must be used.

[ 86-inch model ] : VESA 600 × 400

[ 75-inch model ] : VESA 600 × 400

[ 65-inch model ] : VESA 400 × 400

[ 55-inch model ] : VESA 400 × 400

[ 50-inch model ] : VESA 400 × 400

[ 43-inch model ] : VESA 200 × 200

(see page 11)

- Before installation, be sure to check if the mounting location has enough strength to support the weight of the Display and the wall hanging bracket for anti drop.
- If you terminate the use of the product, ask a professional to remove it promptly.
- When mounting the Display on the wall, prevent the mounting screws and power cable from contacting metal objects inside the wall. An electric shock may occur if they contact metal objects inside the wall.

## ■ When using the LCD Display

The Display is designed to operate on 110 - 240 V ~, 50/60 Hz.

If problems or malfunction occur, stop using immediately.

If problems occur, unplug the power supply plug.

- Smoke or an abnormal odour come out from the unit.
- No picture appears or no sound is heard, occasionally.
- Liquid such as water or foreign objects got inside the unit.
- The unit has deformed or broken parts.

If you continue to use the unit in this condition, it could result in fire or electric shock.

- Unplug the power supply plug from the wall outlet, and then contact the dealer for repairs.
- To cut off the power supply to this Display completely, you need to unplug the power supply plug from the wall outlet.
- Repairing the unit yourself is dangerous, and shall never be done.
- To enable to unplug the power supply plug immediately, use the wall outlet which you can reach easily.

Do not touch the unit directly by hand when it is damaged.

- Electric shock could occur.

Do not stick any foreign objects into the Display.

- Do not insert any metal or flammable objects into the ventilations holes or drop them onto the Display, as doing so can cause fire or electric shock.

Do not remove the cover (cabinet) or modify it.

- High voltages which can cause fire or electric shocks are present inside the Display. For any inspection, adjustment and repair work, please contact your local Panasonic dealer.

Ensure that the mains plug is easily accessible.

The mains plug shall be connected to a mains socket outlet with a protective earthing connection.

Do not use any power supply cord other than that provided with this unit.

- Doing so may cause short-circuit, generates heat, etc., which could cause electric shock or fire.

Do not use the supplied power supply cord with any other devices.

- Doing so may cause short-circuit, generates heat, etc., which could cause electric shock or fire.

Clean the power supply plug regularly to prevent it becoming dusty.

- If there is a build up of dust on the plug, the resultant humidity may cause short-circuit, which could cause electric shock or fire. Unplug the power supply plug from the wall outlet and wipe it with a dry cloth.

Do not handle the power supply plug with wet hands.

- Doing so may cause electric shocks.

Securely insert the power supply plug (socket outlet side) and the power supply connector (main unit side) as far as it will go.

- If the plug is not fully inserted, heat may be generated which could cause fire. If the plug is damaged or the wall socket is loose, they shall not be used.
- **86-inch model**: Make sure that the connector is locked on both the left and right sides.

Do not do anything that may damage the power supply cord or the power supply plug.

- Do not damage the cable, make any modifications to it, place heavy objects on top of it, heat it, place it near any hot objects, twist it, bend it excessively or pull it. To do so may cause fire and electric shock. If the power cable is damaged, have it repaired at your local Panasonic dealer.

Do not touch the power supply cord or the plug directly by hand when they are damaged.

- Doing so may cause electric shock or fire due to short-circuit.

Keep the supplied AAA/R03/LR03 batteries out of reach of children. If accidentally swallowed, it will be harmful to the body.

- Please contact a doctor immediately in case you doubt that the child may have swallowed it.

To prevent the spread of fire, keep candles or other open flames away from this product at all times.



## CAUTION

Do not place any objects on top of the Display.

Ventilation should not be impeded by covering the ventilation openings with items such as newspapers, table cloths and curtains.

- Doing so may cause the Display to overheat, which can cause fire or damage to the Display.

For sufficient ventilation, see page 11.

Do not place the Display where it may be affected by salt or corrosive gas.

- Doing so may cause the Display to fall due to corrosion, and it may result in injury. Also, the unit may malfunction.

The following number of people are required to carry or unpack this unit.

**86-inch model** **75-inch model** : **4 or more**

**65-inch model** **55-inch model** **50-inch model**

**43-inch model** : **2 or more**

- If this is not observed, the unit may drop, resulting in injury.

**When disconnecting the power supply cord, always pull on the plug (socket outlet side) / the connector (main unit side).**

- Pulling the cord may damage the cord, and it may cause electric shock or fire due to short-circuit.

**Be sure to disconnect all cables before moving the Display.**

- If the Display is moved while some of the cables are still connected, the cables may become damaged, and fire or electric shock could result.

**Disconnect the power supply plug from the wall socket as a safety precaution before carrying out any cleaning.**

- Electric shocks can result if this is not done.

**Do not step on, or hang from the Display or the Pedestal.**

- They might tip over, or might be broken and it may result in injury. Pay special attention to the children.

**Do not reverse the polarity (+ and -) of the battery when inserting.**

- Mishandling the battery may cause its explosion or leakage, resulting in fire, injury or damage to surrounding properties.
- Insert the battery correctly as instructed. (see page 15)

**Do not use batteries with the outer cover peeling away or removed.**

- Mishandling the batteries may cause the batteries to short circuit, resulting in fire, injury or damage to surrounding properties.

**If the battery fluid leaks, do not touch it with bare hands, and take the following measures if necessary.**

- Battery fluid on your skin or clothing could result in skin inflammation or injury.  
Rinse with clean water and seek medical advice immediately.
- Battery fluid coming in contact with your eyes could result in loss of sight.  
In this case, do not rub your eyes. Rinse with clean water and seek medical advice immediately.

**Remove the batteries from the remote control transmitter when not using for a long period of time.**

- The battery may leak, heat, ignite or burst, resulting in fire or damage to surrounding properties.

**Remove exhausted batteries from the remote control immediately.**

- Leaving the batteries unattended in it may cause battery leakage, heat or burst.

**Do not burn or breakup batteries.**

- Batteries must not be exposed to excessive heat such as sunshine, fire or the like.

**Do not turn the Display upside down.**

**Do not position the unit with its liquid crystal panel facing upright.**

# Precautions for use

## Cautions when installing

**Install this unit indoors. Avoid the following locations when installing it indoors.**

- Location exposed to rain or wind
- Location with rapid temperature and humidity fluctuations such as vicinity of an air conditioner
- Location subject to vibrations or impacts
- Location close to a sprinkler or sensor

**Install this unit at a location which can support the weight of the unit.**

- Dropping or falling of the unit may cause injury.

**Do not install the unit near a high-voltage line or a power source.**

- Installing the unit near a high-voltage line or a power source may receive interference.

**Install the unit away from heat appliances.**

- Failure to do so may cause deformation of the cabinet or malfunction.

**Environmental temperature to use this unit**

- When using the unit where it is below 1 400 m (4 593 ft) and higher above sea level: 0 °C to 40 °C (32 °F to 104 °F)
- When using the unit at high altitudes (1 400 m (4 593 ft) and higher and below 2 800 m (9 186 ft) above sea level): 0 °C to 35 °C (32 °F to 95 °F)

**Do not install the unit where it is 2 800 m (9 186 ft) and higher above sea level.**

- Failure to do so may shorten the life of the internal parts and result in malfunctions.

**We are not responsible for any product damage, etc. caused by failures in the installation environment even during the warranty period.**

**Transport only in upright position!**

- Transporting the unit with its liquid crystal panel facing upright or downward may cause damage to the internal circuitry.

**Do not grab the liquid crystal panel.**

- Do not forcibly press the liquid crystal panel, or push it with a pointed object. Applying a strong force to the liquid crystal panel will cause unevenness of the screen display, resulting in malfunction.

**Do not install the product to a place where the product is exposed to direct sunlight.**

- If the unit is exposed to direct sunlight even indoors, the temperature rise of the liquid crystal panel may cause malfunction.

**In the case of storage, store the unit in a dry room.**

## Required space for ventilation

- Operation of this unit is guaranteed up to an ambient temperature of 40 °C (104 °F). When installing the unit in a case or chassis, be sure to provide adequate ventilation with a cooling fan or ventilation hole so that the surrounding temperature (inside the case or chassis) including the temperature of the front surface of the liquid crystal panel can be kept at 40 °C (104 °F) or less.

**About the screws used when using a wall hanging bracket that conforms to VESA standards**

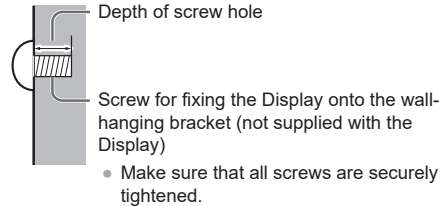

(View from the side)

Inch model	Screw pitch for installation	Depth of screw hole	Screw (quantity)
86	600 mm × 400 mm	20 mm	M8 (4)
75	600 mm × 400 mm	20 mm	M8 (4)
65	400 mm × 400 mm	20 mm	M8 (4)
55	400 mm × 400 mm	18 mm	M6 (4)
50	400 mm × 400 mm	20 mm	M6 (4)
43	200 mm × 200 mm	16 mm	M6 (4)

## Note for connection

**Removing and inserting the power cord and connection cables**

- When the unit has been installed on the wall, if the power cord and connection cables are difficult to remove and insert, make connections first before installation. Be careful not to allow the cables to be entangled. After installation is completed, insert the power plug to the outlet.

## When using

### Image retention may occur.

- If you display a still picture for an extended period, the image might remain on the screen. However, it will disappear when a general moving picture is displayed for a while.

### When polarization sunglasses are worn, the screen display may be invisible.

- This phenomenon occurs due to deflection characteristics of the liquid crystal panel. This is not a malfunction.

### Red, blue or green dots on the screen are a liquid crystal panel-specific phenomenon. This is not a malfunction.

- Although the liquid crystal display is manufactured with high-precision technology, always-lighting dots or non-lighting dots may appear on the screen. This is not a malfunction.

Inch model	Dot omission ratio*
86	0.00009% or less
75	0.00007% or less
65	0.00005% or less
55	0.00005% or less
50	0.00005% or less
43	0.00005% or less

\*: Calculated in sub-pixel units according to the ISO9241-307 standard.

### Depending on the temperature or humidity conditions, uneven brightness may be observed. This is not a malfunction.

- This unevenness will disappear while applying current continuously. If not, consult the distributor.

### If the Display is not going to be used for any prolonged length of time, unplug the power supply plug from the wall outlet.

- When storing the product for long periods with no power supplied, do not store it in a location exposed to direct sunlight.

### If the power is instantaneously interrupted or stopped, or if the power voltage is instantaneously lowered, the Display may not operate normally.

- In this case, turn off the power of the Display and the connected devices once, and then turn on the power again.

### Picture noise may occur if you connect / disconnect the cables connected to the input terminals you are currently not watching, or if you turn the power of the video equipment on / off, but it is not a malfunction.

## Notes on Using Wired LAN

### When setting up the Display at a place, where electric static occurs often, take a sufficient antistatic measure before start using.

- When the Display is used at a location, where static electricity occurs often, such as on a carpet, a wired LAN communication is disconnected more often. In that case, remove static electricity and the noise source that may cause problems with an antistatic mat, and re-connect the wired LAN.
- In rare cases, the LAN connection is disabled due to static electricity or noise. In that case, turn off the power of the Display and the connected devices once and then re-turn on the power.

### The Display may not work properly due to strong radio wave from the broadcast station or the radio.

- If there is any facility or equipment, which outputs strong radio wave, near the installation location, set up the Display at a location sufficiently far from the source of the radio wave. Or, wrap the LAN cable connected to the LAN terminal by using a piece of metal foil or a metal pipe, of which is grounded at both ends.

## Request Regarding Security

### When using this unit, take safety measures against the following incidents.

- Personal information being leaked via this unit
- Unauthorized operation of this unit by a malicious third party
- Interfering or stopping of this unit by a malicious third party

### Take sufficient security measures.

- Set a password for LAN control and restrict the user who performs the control.
- Make your password difficult to guess as much as possible.
- Change your password periodically.
- Panasonic Projector & Display Corporation or its affiliate companies will never ask for your password directly. Do not divulge your password in case you receive such inquiries.
- The connecting network must be secured by a firewall, etc.
- When disposing the product, initialize the data before disposing.

## Cleaning and maintenance

**First, remove the mains plug from the mains socket.**

**Gently wipe the surface of the liquid crystal panel or cabinet by using a soft cloth to remove dirt.**

- To remove stubborn dirt or fingerprints on the surface of the liquid crystal panel, dampen a cloth with diluted neutral detergent (1 part detergent to 100 parts water), wring out the cloth firmly, and then wipe away the dirt. Finally, wipe away all the moisture with a dry cloth.
- If water droplets get inside the unit, operating problems may result.

### Note

- The surface of the liquid crystal panel is specially treated. Do not use a hard cloth or rub the surface too hard, otherwise this may cause scratches on the surface.

### Usage of a chemical cloth

- Do not use a chemical cloth for the liquid crystal panel surface.
- Follow the instructions for the chemical cloth to use it for the cabinet.

**Avoid contact with volatile substances such as insect sprays, solvents and thinner.**

- This may cause damage to the cabinet or cause peeling of the paint. Furthermore, do not leave it in contact with a rubber or PVC substance for a long time.

**Remove dust and dirt from the ventilation holes.**

- Dust may adhere to the vicinity of the ventilation holes depending on the usage environment. As a result, if the internal cooling of this unit or circulation of exhaust heat deteriorates, it may result in a decrease in brightness or a malfunction. Clean and remove dust from the ventilation holes.
- The amount of dust and dirt that adheres depends on the installation location and usage time.

## Disposal

**When disposing the product, ask your local authority or dealer about the correct methods of disposal.**

**Do not disassemble the product before disposal.**

# Accessories

## Accessories Supply

Check that you have the accessories and items shown.

### Power supply cord

TH-86EQ3W

(Approx. 2 m)

- 1JP155AF1U

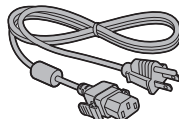

- 2JP155AF1W

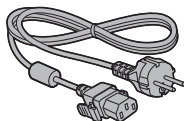

- 3JP155AF1W

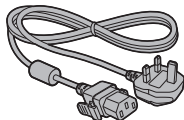

TH-75EQ3W, TH-65EQ3W, TH-55EQ3W, TH-50EQ3W, TH-43EQ3W

(Approx. 2 m)

- 1JP143CQ2U

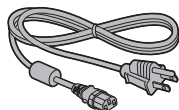

- 2JP143EQ2W

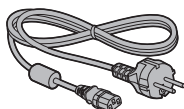

- 3JP143EQ2W

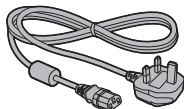

### Remote Control Transmitter

× 1

- DPVF2599ZC/X1



### Batteries for the Remote Control Transmitter × 2

(AAA/R03/LR03 type)

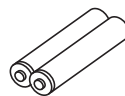

### Clamper (large) × 2

- DPVF1654ZA

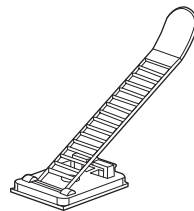

#### Attention

- Store small parts in an appropriate manner, and keep them away from young children.
- The part numbers of accessories are subject to change without notice. (The actual part number may differ from the ones shown above.)
- In case you lost accessories, please purchase them from your dealer. (Available from the customer service)
- Dispose the packaging materials appropriately after taking out the items.

## Remote Control Batteries

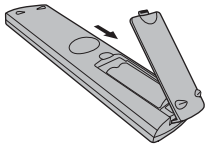

Open the battery cover.

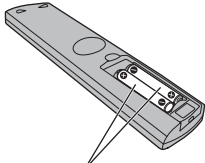

Insert batteries and close the battery cover.

(Insert starting from the ⊖ side.)

AAA/R03/LR03 type

### Note

- Incorrect installation of the batteries can cause battery leakage and corrosion that will damage the remote control.
- Disposal of batteries should be done in an environment-friendly manner.

### Take the following precautions.

1. Batteries shall always be replaced as a pair.
2. Do not combine a used battery with a new one.
3. Do not mix battery types (example; manganese dioxide battery and alkaline battery etc.).
4. Do not attempt to charge, disassemble or burn used batteries.
5. Do not burn or breakup batteries.

Moreover, batteries must not be exposed to excessive heat such as sunshine, fire or the like.

## Cautions when moving

86-inch model

75-inch model

65-inch model

The Display has handles for carrying. Hold them when moving.

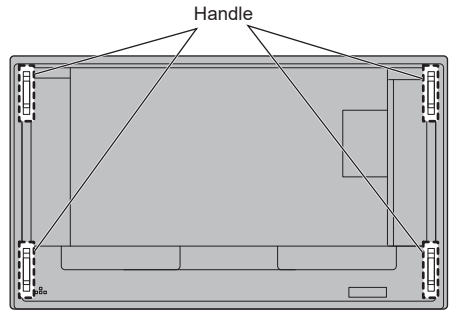

### Note

- Do not hold parts other than the handles.
- The following number of people are required to carry this unit.

86-inch model

75-inch model

: 4 or more

65-inch model

55-inch model

50-inch model

43-inch model

: 2 or more

If this is not observed, the unit may drop, resulting in injury.

- When carrying the unit, keep the liquid crystal panel upright.  
Carrying the unit with the surface of the liquid crystal panel facing up or down may cause deformation of the panel, or internal damage.
- Do not hold the upper, lower, right and left frames or the corners of the unit. Do not hold the front surface of the liquid crystal panel. Also, do not hit such parts.  
Doing so may damage the liquid crystal panel.  
Also, the panel may crack, resulting in injury.

# Kensington security

The security slot of this unit is compatible with the Kensington security slot.

86-inch model 75-inch model 65-inch model

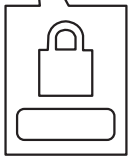
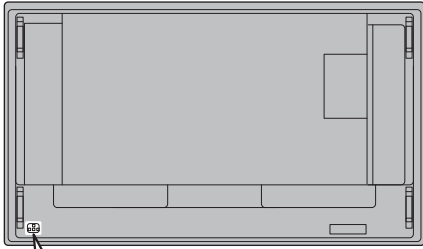

55-inch model 50-inch model 43-inch model

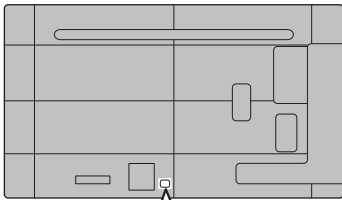

# Eyebolt 86-inch model 75-inch model

The Display has holes for attaching eyebolts (M10). When installing, use them to suspend the Display. Use the eyebolt only for temporary suspension or movement for installation. This cannot be used for permanent hanging installation.

Eyebolt (commercially available) mounting positions

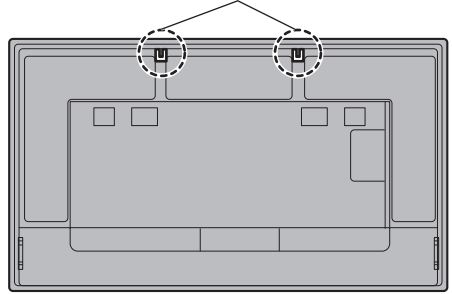

**Attach the eyebolt on the eyebolt mounting position (two locations).**

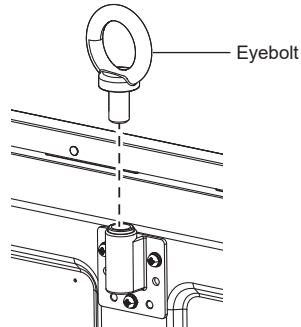

## Note

- Installation should be performed by an installation professional.
- Do not suspend using only 1 eyebolt.
- Use commercially sold M10 eyebolts with a shank length of 12 mm to 40 mm that satisfies the load condition of product quality.
- Use ISO 3266 standard eyebolts. Also use ISO standard members (wire, etc.) for hanging.
- The hanging angle should be 60° or more.

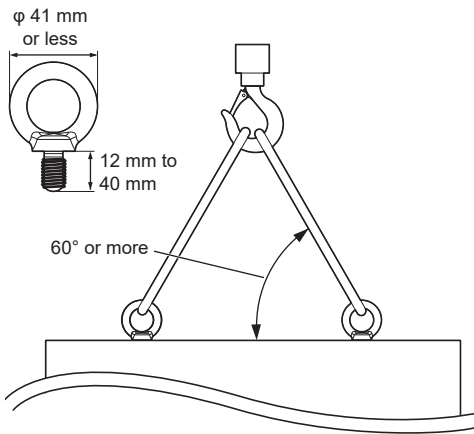

# Connections

75-inch model    65-inch model    55-inch model  
50-inch model    43-inch model

## AC cord connection and fixing / Cable fixing

86-inch model

Back of the unit

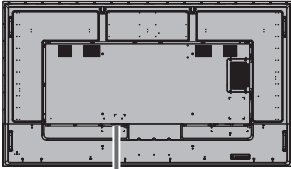

### AC cord fixing

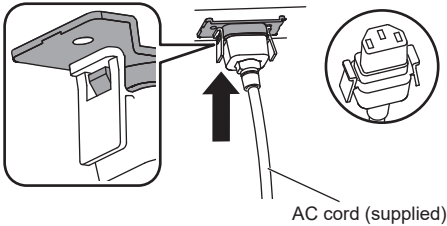

### Plug the connector into the display unit.

Plug the connector until it clicks.

#### Note

- Make sure that the connector is locked on both the left and right sides.

### Unplug the AC cord

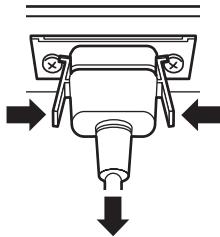

Unplug the connector pressing the two knobs.

#### Note

- Do not use an AC cord of which the knobs are damaged. If it is used with the knobs damaged, a bad connection may result between the AC cord connector and the AC IN terminal. For the repair of the AC cord, consult the dealer where you purchased the product.
- When disconnecting the AC cord, be absolutely sure to disconnect the AC cord plug at the socket outlet first.
- The supplied AC cord is for this unit exclusive use. Do not use this for other purposes.

Back of the unit

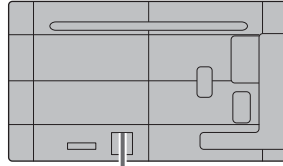

Insert the AC cord securely all the way seated on the back side of the unit.

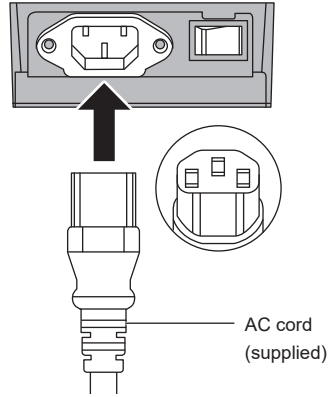

#### Note

- When disconnecting the AC cord, be absolutely sure to disconnect the AC cord plug at the socket outlet first.
- The supplied AC cord is for this unit exclusive use. Do not use this for other purposes.

## Cable fixing

### Note

- 2 clampers are supplied with this unit. Fix the cables at location as shown below.

If you need more clampers, purchase them from your dealer. (Available from the customer service)

86-inch model    75-inch model    65-inch model

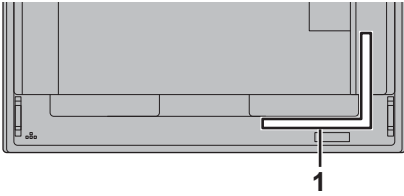

55-inch model    50-inch model    43-inch model

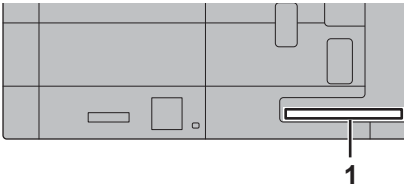

## 1 For signal cable: clumper

### 1. Attach the clumper

#### Note

- Wipe off dirt, such as dust, water and oil on the attachment surface, and affix the clumper on the attachment surface by pushing it firmly.
- Once the clumper is affixed, it cannot be reused. Be sure to confirm the attaching position before affixing it.

Remove the tape at the back, and affix the clumper on the flat surface.

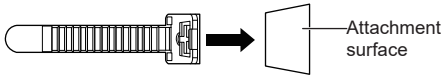

### 2. Bundle the cables

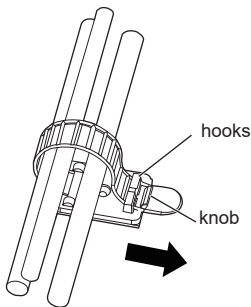

#### To loosen:

Remove the band from the knob, and pull out the band tip.

## Video equipment connection

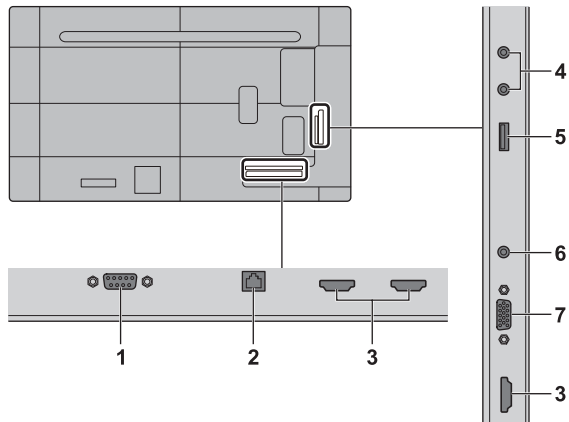

---

**1 SERIAL IN:**      **SERIAL Input Terminal**  
Control the Display by connecting to PC.  
(see page 23)

---

**2 LAN:**            **LAN Terminal**  
Control the Display by connecting to Network.  
(see page 45)

---

**3 HDMI IN 1,  
HDMI IN 2,  
HDMI IN 3:**      **HDMI Input Terminal**  
Connect to video equipment such as VCR or DVD player, etc.  
(see page 21)

- Use a commercially available HDMI cable (conforming to the HDMI standard) that supports 4K.

---

**4 AUDIO OUT:**    **Analogue Audio Output Terminal**  
Connect to audio equipment with analogue audio input terminal.  
(see page 25)

---

**5 USB:**            **USB Terminal**  
Connect the USB memory to use USB media file playback, USB data cloning, etc. Also, this can be used to supply power of up to 5 V / 2 A to an external device when the picture is displayed.  
(see page 25)

---

---

**6 AUDIO IN:**      **Audio Input Terminal**

---

**7 PC IN:**          **PC Input Terminal**  
Connect to video terminal of PC.  
(see page 22)

---

## Before connecting

- Before connecting cables, carefully read the operating instructions for the external device to be connected.
- Turn off the power of all devices before connecting cables.
- Take note of the following points before connecting the cables. Failure to do so may result in malfunctions.
  - When connecting a cable to the unit or a device connected to the unit itself, touch any nearby metallic objects to eliminate static electricity from your body before performing work.
  - Do not use unnecessarily long cables to connect a device to the unit or to the unit body. The longer the cable, the more susceptible to noise it becomes. Since using a cable while it is wound makes it act like an antenna, it is more susceptible to noise.
  - When connecting cables, insert them straight into the connecting terminal of the connecting device so that the ground is connected first.
- Acquire any cable necessary to connect the external device to the system that is neither supplied with the device nor available as an option.
- If the outer shape of the plug of a connection cable is large, it may come in contact with the periphery such as a back cover or the plug of an adjacent connection cable. Use a connection cable with the suitable plug size for the terminal alignment.
- When connecting the LAN cable with plug cover, be aware that the cover may come in contact with the back cover and it may be difficult to disconnect.
- Some PC models are not compatible with the unit.
- Use cable compensator when you connect devices to the unit using long cables. Otherwise the image may not be displayed properly.
- Refer to "Preset Signals" (see page 61) for the types of video signals that can be displayed with the unit.

## HDMI IN 1, HDMI IN 2 and HDMI IN 3 terminals connection

### Note

- Video equipment and HDMI cable shown are not supplied with this unit.
- Connect the equipment complying with the HDMI standard.
- Some HDMI equipment may not be able to display picture.
- This Display does not support VIERA LINK.

### Attention

- Use an HDMI High Speed cable complying with the HDMI standards. Note when inputting 4K video signals exceeding the transmission speed supported by an HDMI High Speed cable, use an HDMI cable supporting 18 Gbps high-speed transmission such as the one certified as a Premium HDMI cable. When inputting video signals exceeding the transmission speed supported by the HDMI cable you are using, malfunction may occur such as interrupted pictures and no display on the screen.

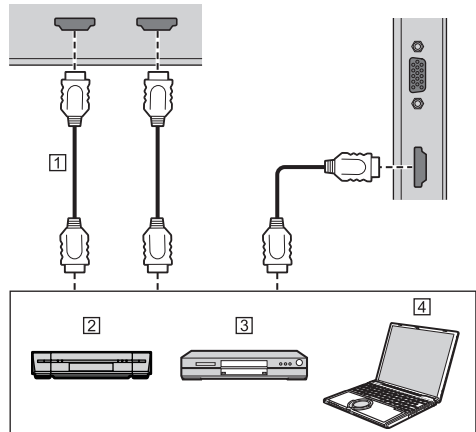

- 1 HDMI cable (commercially available)
- 2 Video Cassette Recorder
- 3 DVD Player
- 4 PC

## Pin assignments and signal names for HDMI Terminal

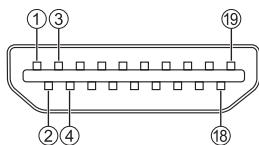

Pin No.	Signal name
①	T.M.D.S Data2 +
②	T.M.D.S Data2 Shield
③	T.M.D.S Data2 -
④	T.M.D.S Data1 +
⑤	T.M.D.S Data1 Shield
⑥	T.M.D.S Data1 -
⑦	T.M.D.S Data0 +
⑧	T.M.D.S Data0 Shield
⑨	T.M.D.S Data0 -
⑩	T.M.D.S Clock +
⑪	T.M.D.S Clock Shield
⑫	T.M.D.S Clock -
⑬	CEC
⑭	_____
⑮	DDC SCL
⑯	DDC SDA
⑰	DDC/CEC Ground
⑱	+5 V DC
⑲	Hot Plug Detect

## PC IN terminal connection

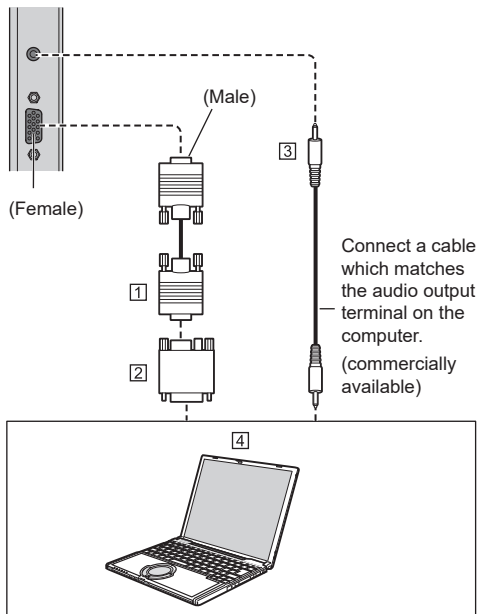

- ① Mini D-sub 15p cable (commercially available)
- ② Conversion adapter (if necessary) (commercially available)
- ③ Stereo mini plug (M3) cable (commercially available)
- ④ PC

### The type of computer signal that can be connected

- With regard to the typical PC input signals that are described in "Preset Signals" (see page 61), adjustment values such as for the standard picture positions and sizes have already been stored in this unit.

(Computer signals which can be input are those with a horizontal scanning frequency of 31 to 83 kHz and vertical scanning frequency of 56 to 76 Hz.)

- If signals outside the range of supported frequencies are input, normal images cannot be displayed. Note that some images may not be correctly displayed even if signals are within the range.
- If the PC screen is not displayed, check if the image signal of the PC meets "Preset Signals" (see page 61), and then change the settings. For power-saving purpose, image output may be OFF on a notebook computer. In this case, it may be set to ON with function key operation etc. of the computer. (Refer to the manual of the computer.)

**Note**

- The sync signal only supports HD/VD signal input.
- Additional computer, cables and conversion adapter shown are not supplied with this set.
- If the computer being connected is not DDC2B-compatible, you will need to make setting changes to the computer at the time of connection.
- When connecting a computer equipped with a D-sub15 pin terminal or a Mac, use a commercially sold conversion adapter as necessary.
- \* There is no need to use an adapter for computers with DOS/V compatible Mini D-sub 15P terminal.
- Do not set the horizontal and vertical scanning frequencies for PC signals which are above or below the specified frequency range.
- For audio, the AUDIO IN terminal can be used.

**Pin assignments and signal names for PC Input Terminal (Mini D-sub 15P)**

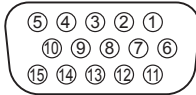

Pin No.	Signal Name
①	Red video signal input
②	Green video signal input
③	Blue video signal input
④	NC (not connected)
⑤	GND
⑥	GND for red video signal
⑦	GND for green video signal
⑧	GND for blue video signal
⑨	+5 V DC
⑩	GND (Ground)
⑪	NC (not connected)
⑫	DDC SDA
⑬	Hsync Signal input (HD)
⑭	Vsync Signal input (VD)
⑮	DDC SCL

**RS232 terminal connection**

The RS232 terminal conforms to the RS-232C interface specification, so that the Display can be controlled by a computer which is connected to this terminal.

**Note**

- Additional computer and cables shown are not supplied with this set.

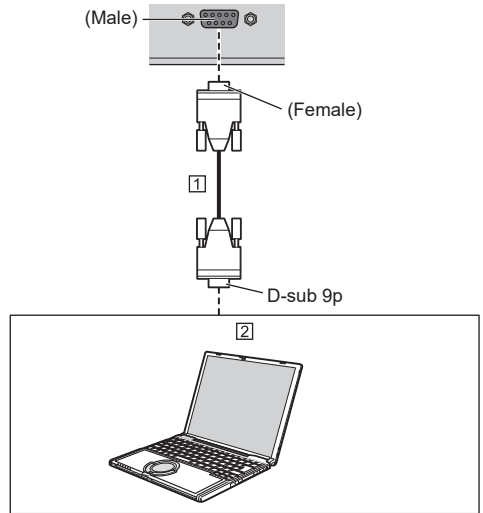

① RS-232C Straight cable (commercially available)

② PC

**Note**

- Select the RS-232C straight cable for communication used for connecting RS232 terminal and computer according to the computer you are using.

**Pin assignments and signal names for SERIAL Terminal**

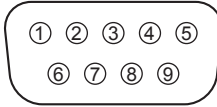

Pin No.	Signal Name
①	NC (not connected)
②	Received data
③	Transmitted data
④	NC (not connected)
⑤	GND (Ground)
⑥	NC (not connected)
⑦	NC (not connected)
⑧	NC (not connected)
⑨	NC (not connected)

These signal names are those of computer specifications.

**Communication parameters**

- Signal level: RS-232C compliant
- Synchronization method: Asynchronous
- Baud rate: 9 600 bps
- Parity: None
- Character length: 8 bits
- Stop bit: 1 bit
- Flow control: None

**Basic format for control data**

The transmission of control data starts with a STX signal, followed by the command, the parameters, and lastly an ETX signal in that order. If there are no parameters, the colon ":" does not need to be sent.

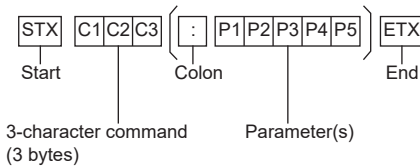

**Command**

Command	Parameter	Control details
PON	(None)	Power ON
POF	(None)	Power OFF
AVL	***	VOLUME 000 - 100
AMT	0	Audio MUTE OFF
	1	Audio MUTE ON
IMS	(None)	Input select (toggle)
	HM1	HDMI IN 1 input (HDMI1)
	HM2	HDMI IN 2 input (HDMI2)
	HM3	HDMI IN 3 input (HDMI3)
	PC1	PC IN input (PC)
	UD1	USB input (USB)
DAM	FULL	Full
	NORM	Normal
	NATV	Native
	ZOOM	Zoom

**Communication interval**

After getting the feedback, then you can continue the following commands.

Suggest setting a timeout for the command response. (specify 10 seconds or longer)

When sending multiple commands, be sure to receive a response from this unit, and then send the next command.

**Note**

- If an incorrect command is sent, this unit will reply an "ER401" command to the computer.
- If communication has not been established for reasons such as a bad connection between the computer and Display, nothing is returned (not even ER401).
- "ER401" may be returned when a command cannot be received correctly due to interference from the surrounding environment.

Please ensure that the system or software resends the command if this occurs.

- When sending a command which does not require parameter, a colon (:) is not needed.
- Consult your local Panasonic dealer for detail instructions on command usage.

For more details, visit the following web site.

<https://docs.connect.panasonic.com/prodisplays/>

## AUDIO OUT terminal connection

### Note

- Audio equipment and the cable shown are not supplied with this set.

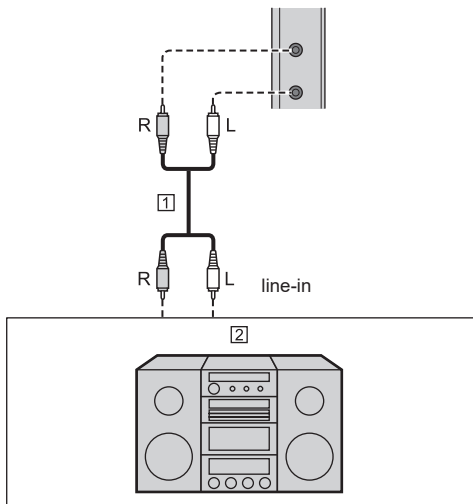

1 Stereo audio cable (commercially available)

2 Audio equipment

## USB terminal connection

Connect a USB memory device to the USB port.

### Note

- Do not connect a USB device other than a USB memory device.
- Turn off the power of the Display when removing a USB memory device.
- If the power is turned off or the USB memory device is removed while accessing data in the USB memory device, the stored data may be destroyed. The access indicator of the USB memory device blinks during data access.

### Supported USB memory device

File System	FAT32
Capacity	Up to 32GB (maximum file size 4 GB)

### Note

- Do not use a USB memory device with a security function or a write protection function.
- Multi partition is not supported.
- Use a USB memory device with a shape that can be inserted in the USB port. Some USB memory devices with special shapes cannot be inserted. Do not forcibly insert a USB memory device. This may damage the connector and cause failure.

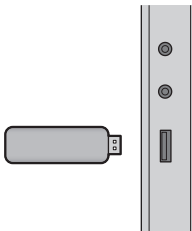

## Pin assignments and signal names for USB Terminal

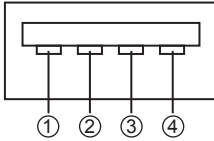

Pin No.	Signal name
①	+5 V DC
②	DATA -
③	DATA +
④	GND (Ground)

Power of up to 5 V / 2.0 A can be supplied to an external device when the picture is displayed.

### Note

- If the direct connection to this unit is not possible due to the size of a stick PC, etc. use a commercially sold extension cable.
- Depending on the type of a USB memory device, it may come in contact with the periphery such as a back cover, and cannot be attached. Use a USB memory device connectable to this unit.
- When connecting the USB memory device, confirm the orientation of the plug to prevent damage to the terminal.
- When removing the USB memory device, note the following.
  - When the access indicator of the connected USB memory device is blinking, it shows the Display is loading the data. Do not remove the USB memory device while blinking.
  - Depending on the USB memory device, the access indicator may remain blinking even when it is not being accessed, or the device is not equipped with an access indicator function, etc. In this case, remove the USB memory device after confirming the following ① or ②.
    - ① Switch the input to an input other than [USB], and confirm that the functions that access USB memory device are finished.
    - ② Turn the unit off.
- Do not frequently repeat connecting/disconnecting the USB memory device. Wait at least 5 seconds after connection, and then remove the USB memory device. Before reconnection, wait at least 5 seconds. A certain length of time is required so that the Display can recognise that the USB memory device is switched for connection or disconnection.
- If the power of this unit is turned off or the USB memory device is removed accidentally while accessing data, the data may not be accessed next time the USB memory device is used.

In such a case, turn the power of the main unit off and on.

# Identifying Controls

## Display

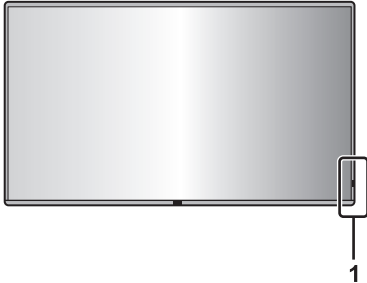

### 1 Power Indicator / Remote control sensor

The Power Indicator will light.

**When the power of the unit is ON**

**(Power button (⏻/⏻) (Unit): ON)**

- Picture is displayed: Blue
- When the unit enters the standby mode: Orange or purple

**When the unit enters the standby state with the following functions: Purple**

- Standby state when [Power save mode] is set to [Disable]  
For details of the [Power save mode] function (see page 42)
- Standby state when the [Power Management] function is activated  
For details of the [Power Management] function (see page 42)
- Standby state when the [Setup Timer] function is being used  
For details of the [Setup Timer] function (see page 37)
- Standby state when [Quick start] is set to [On]

**Standby states in conditions other than the above: Orange**

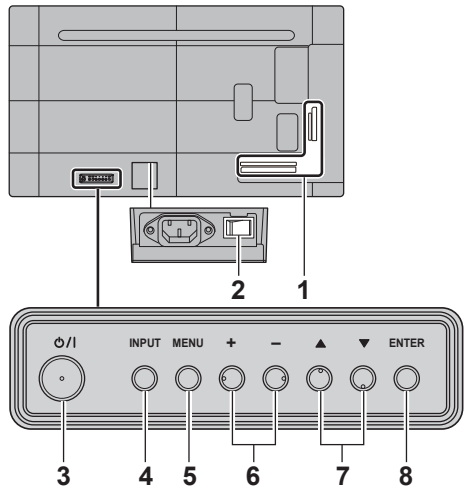

### 1 External input / output terminal

Connects to video equipment, PC, etc. (see page 20)

### 2 Main power switch (⏻/⏻) (Unit)

Turns OFF (⏻) or ON (⏻) the main power.

Turning ON and OFF the <Main power switch> is the same as plugging and unplugging the power plug.

Turn ON (⏻) the main power first, and then turn OFF or ON the power using the Power button of the remote control or the unit.

### 3 Power button (⏻/⏻) (Unit)

When the <Main power switch> of the Display is turned ON (⏻), use this button to turn the power on or let the unit enter the standby state. (see page 30)

### 4 INPUT (Unit)

Selects the connected device. (see page 30)

### 5 MENU (Unit)

Displays the menu screen. (see page 33)

### 6 + (Unit) / - (Unit)

Adjusts the volume. (see page 31)

On the main screen, switches settings or adjusts settings level. (see page 33)

### 7 ▲ (Unit) / ▼ (Unit)

Selects the setting item on menu screen. (see page 33)

### 8 ENTER (Unit)

Configures the item on menu screen. (see page 33)

#### Note

- To output sound from the built-in speakers of the unit, be sure to set [Speaker] in the [Sound] menu. (see page 36)

## Remote Control Transmitter

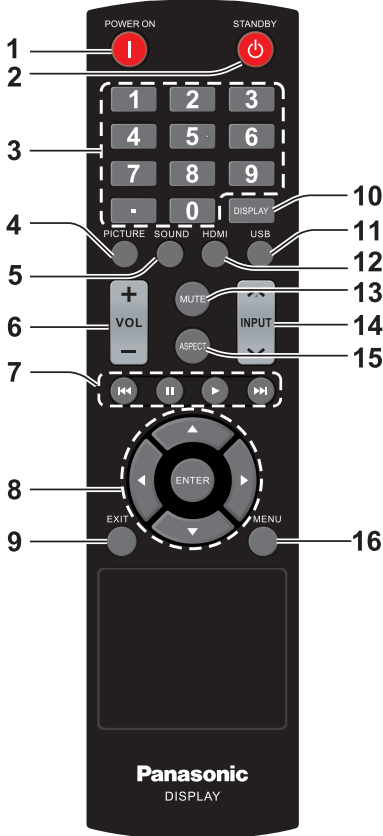

### 1 POWER ON button (I)

- Turns the power on (Picture is displayed) when the Display is turned off (Standby condition).

### 2 STANDBY button (⏻)

- Turns the power off (Standby condition) when the Display is turned on.

### 3 Numeric buttons (0 - 9) / ·

- Inputs numbers in LAN settings and USB data cloning.

### 4 PICTURE

- Adjust Picture mode. (see page 35)

### 5 SOUND

- Displays a screen for changing the sound quality of the Display  
Each time <SOUND> is pressed, the setting changes as follows.  
Treble → Bass

### 6 VOL + / VOL -

- Adjusts sound volume level. (see page 31)

### 7 Navigation keys (◀, ⏸, ▶, ▶▶)

- Used in the USB menu and HDMI CEC function.

### 8 ENTER / Cursor buttons (▲▼◀▶)

- Used to operate the menu screens. (see page 33)

### 9 EXIT

- Turns off the menu screens. (see page 33)

### 10 DISPLAY

- Displays information about the Display. (see page 31)

### 11 USB

- Switches to USB input.

### 12 HDMI

- Switches to HDMI input.

### 13 MUTE

- Sound mute on / off. (see page 31)

### 14 INPUT ▲ / ▼

- Switches input to display on the screen. (see page 30)

### 15 ASPECT

- Change aspect ratio. (see page 32)

### 16 MENU

- Press to open the OSD menu. (see page 33)

#### Note

- In this manual, buttons of the remote control and the unit are indicated as < >.

(Example: <INPUT>.)

The operation is mainly explained indicating the remote control buttons but you can also operate with the buttons on the unit when there are the same buttons.

# Basic Controls

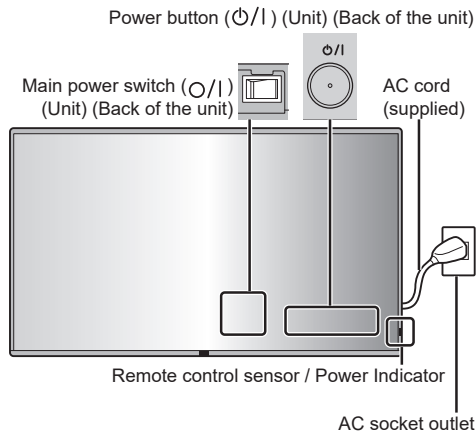

Operate pointing the remote control directly at the unit's Remote Control Sensor.



## Note

- Do not put an obstacle between the remote control sensor of the main unit and the remote control.
- Operate the remote control in front of the remote control sensor or from the area where the sensor can be seen.
- When directly aiming the remote control at the remote control sensor of the main unit, the distance from the front of remote control sensor should be approx. 7 m or less. Depending on the angle, the operation distance may be shorter.
- Do not subject the remote control sensor of the main unit to the direct sunlight or strong fluorescent light.

## 1 Connect the AC cord plug to the Display.

(see page 18)

## 2 Connect the plug to the socket outlet.

### Note

- When disconnecting the AC cord, be absolutely sure to disconnect the AC cord plug at the socket outlet first.
- The settings may not be saved if the power plug is disconnected immediately after changing settings with on-screen menu. Disconnect the power plug after a enough period of time. Or, disconnect the power plug after turning the power off with the remote control, RS-232C control or LAN control.

## 3 Turn ON (|) the <Main power switch (⏻/⏻)> on the unit.

## 4 Press the <Power button (⏻/⏻)> on the unit to turn the power of the unit ON.

- Power Indicator: Blue (Picture is displayed.)
- When the <Main power switch> is ON (|), the power indicator lights up and remote control operation is possible.
- When the power indicator is lit, it is not necessary to press the <Power button (⏻/⏻)> on the unit. Operate the remote control so that the power indicator turns blue (picture is displayed).

## ■ To turn the power ON/OFF with the remote control

### To turn the power on

- When the <Main power switch> is ON ( | ) (Power Indicator - orange or purple), press <POWER ON button ( | )> then the picture will be displayed.
- Power Indicator: Blue (Picture is displayed.)

### To turn the power off (Standby condition)

- When the <Main power switch> is ON ( | ) (Power Indicator - blue), press <STANDBY button (Ⓞ)>, then the power will be turned off.
- Power Indicator: Orange or purple (standby)
- The display turns off if the <Main power switch> is turned OFF (Ⓞ) while the unit is ON (picture is displayed) or OFF (standby state).

#### Note

- After the power plug is disconnected, the power indicator may remain lit for a while. This is not a malfunction.

## ■ When the Unit is turned on for the first time

Following screen will be displayed.

### When setting [Quick start], select [On] with ◀▶ and press <ENTER>.

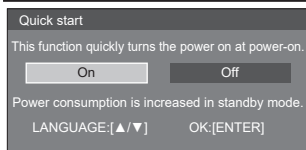

#### Note

- Placing the cursor on [On] on the [Quick start] setting screen displays the following message.  
"Power consumption is increased in standby mode."
- Once the items are set, the screens won't be displayed when switching on the unit next time. Each item can be reset in the following menus.  
[Quick start]
- The OSD language can be selected with ▲ ▼.

## Selecting the input signal

Select the signals input to the unit.

Press <INPUT> or <INPUT (Unit)>.



Unit

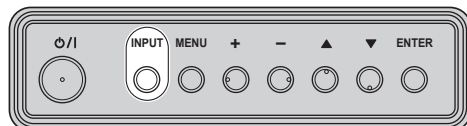

Input
HDMI1
HDMI2
HDMI3
PC
USB

[HDMI1]: HDMI IN 1 terminal, HDMI input

[HDMI2]: HDMI IN 2 terminal, HDMI input

[HDMI3]: HDMI IN 3 terminal, HDMI input

[PC]: PC Input Terminal

[USB]: USB terminal, USB input

## Confirming the input signal, screen mode, etc.

Display information about the Display.

Press <DISPLAY>.

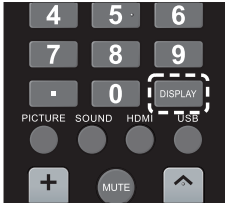

Each time you press <DISPLAY>, the display changes.

Information1 → Information2 → No display

## Volume Adjustment

Press <VOL +> <VOL -> or <+ (Unit)> <- (Unit)> to adjust volume.



Unit

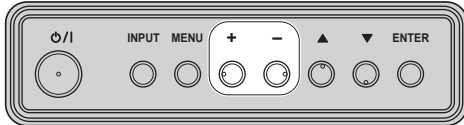

6

- The current sound volume level is memorised even if the power is turned off.

## Sound mute On / Off

It is useful when you want to mute the sound temporarily, for example, when answering the phone or door.

Press <MUTE>.

-  appears on the screen and the sound is muted. Press again to reactivate the sound.



- It is also reactivated when the power is turned on / off or the volume level is changed.

# ASPECT Controls

Press <ASPECT> to move through the aspect options:



[Normal] → [Zoom] → [Full] → [Native]

### Note

- The aspect mode is memorised separately for each input terminal.

### ■ List of Aspect Modes

Aspect mode	Description
Normal	<p><b>Picture</b> → <b>Enlarged screen</b></p> <p>Pictures are displayed with the aspect ratio of input signals.</p>
Zoom	<p>Pictures are displayed in full screen with the aspect ratio of input signals. Edges of the pictures may not be displayed.</p>
Full	<p>Pictures are displayed filling the screen.</p>
Native	<p>According to the input signals to display the picture. Refer to "Preset Signals" (see page 61) for the applicable input signal that can be displayed.</p>

### Note

- [Native] cannot be used for video signals exceeding the resolution of 3 840 x 2 160 and for the interlace signal.
- [Zoom] cannot be used with PC input.
- Using this display's screen-size switching function to compress or expand the screen for commercial or public viewing in establishments like cafes or hotels may infringe on the rights of the creators, as protected by Copyright Law, so please be careful.
- The appearance of the original video may change if you select a screen size with a different aspect ratio than the original image (e.g. video input from external equipment).
- When 4:3 video is viewed with the whole screen using the screen-size switching function of this display, the edge of the video may be lost or appear distorted. If you wish to respect the creator's intentions, set the screen size to [Normal].
- When playing commercial software, parts of the image (like subtitles) may be cropped. In this case select the optimal screen size using the screen-size switching function of this display. With some software, there may be noise or distortion at the edges of the screen. This is due to the characteristics of the software, and is not a malfunction.
- Depending on the original video size, black bands may remain at the edges of the screen.

# On-Screen Menu Displays

## 1 Display the menu screen.

Remote Control

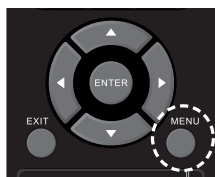

Press to select.

Unit

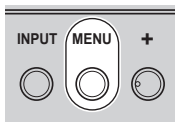

## 2 Select the item.

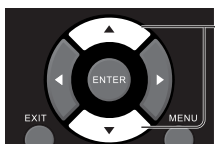

Press to select.

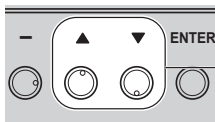

Press to select.

(Example: [Picture] menu)

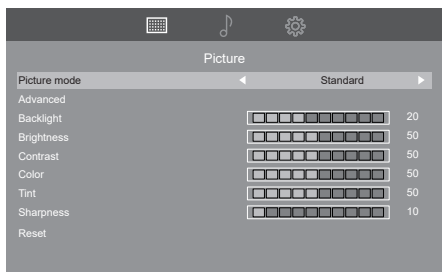

To display the submenu, press <ENTER>.

## 3 Set.



Press to set.

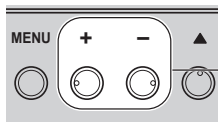

Press to set.

## 4 Exit from the menu.

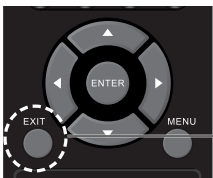

Press to exit the menu.

Press <MENU> to return to the previous screen.

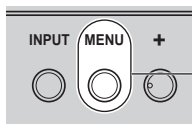

Press

### Note

- When changing the settings of the display, picture or sound disturbance may occur temporarily. This is not a malfunction.

## Menu display list

- Menu that cannot be adjusted is greyed out.  
Adjustable menu changes depending on signal, input and menu setting.

## [Picture] menu

(see page 35)

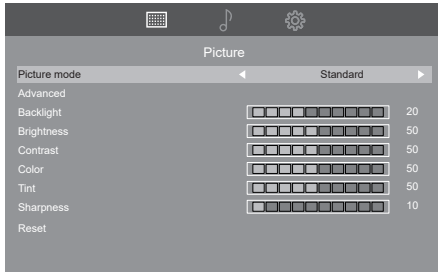

## [Sound] menu

(see page 36)

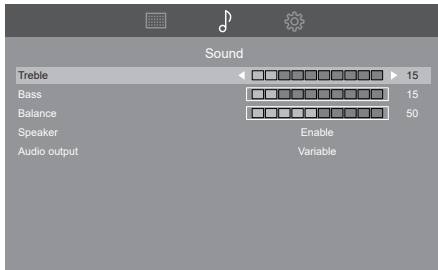

## [Setup] menu

(see page 37 – 44)

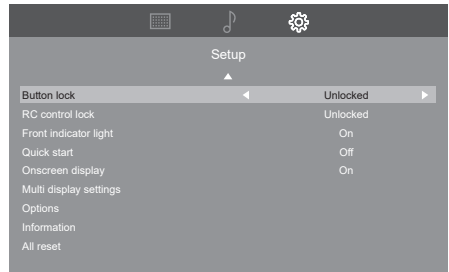
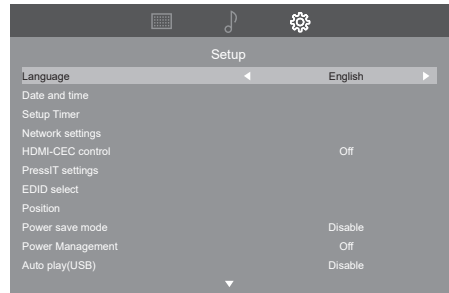

# Picture Adjustments

## 1 Press <MENU> to display the [Picture] menu.

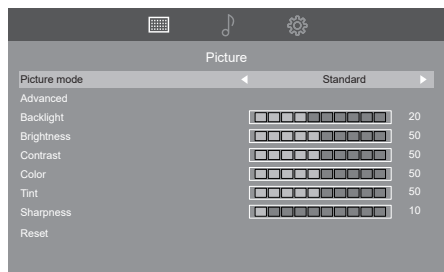

## 2 Select the item to adjust with <▲▼>.

- Menu that cannot be adjusted is greyed out.

## 3 Adjust with <◀▶>.

## 4 Press <EXIT> to exit from adjust mode.

### ■ To return to the previous screen

Press <MENU>.

#### [Picture mode]

This menu switches to easy-to-see pictures suitable to the picture source or environment where this unit is used.

#### [Dynamic]:

Improves contrast and sharpness for viewing in a bright room.

#### [Sports]:

Suitable for sports matches.

#### [Graphic]:

Suitable for PC input.

#### [Standard]:

For viewing in standard (evening lighting) environments.

#### [Advanced]

Selects advanced video settings.

#### [Aspect ratio]:

Changes the aspect mode. (see page 32)

#### [Overscan]:

Sets the scan mode.

#### [Color temperature]:

Adjusts colour tone.

#### [Preset]:

The preset color temperatures (6500K/9300K/12000K/Native) can be set.

#### Note

- Smaller the [Preset] value, red is emphasized. Larger the [Preset] value, blue is emphasized.
- When [Native] is selected, the original colour tone for the LCD panel is reproduced.

#### [Custom]:

The colour temperature can be set by the user.

#### [Noise reduction]:

Sets to reduce the video noise.

#### Note

- This menu is grayed out for signals other than HDMI YUV signal.

#### [Dynamic backlight control]:

Optimizes the backlight brightness to enhance contrast and reduce total power consumption.

#### [Gamma]:

Selects the gamma curve.

#### [HDMI RGB Signal Range]:

Switches the dynamic range depending on the input signal of the HDMI terminal.

This is enabled only for RGB signal input.

#### [Video(16-235)]:

When the input signal is in video range

#### [Full(0-255)]:

When the input signal is in full range

#### [Auto]:

Automatically switches the dynamic range to [Video(16-235)] or [Full(0-255)] depending on the input signal.

#### [Dynamic contrast]:

Automatically adjusts the contrast by determining the changes in the use of colours for images that constantly change, such as motion pictures.

- The adjustment operation may not be smooth depending on the image. In this case select [Off].

#### Note

- This menu is grayed out for signals other than HDMI YUV signal.

- [Backlight]** Selects the proper brightness and density for the room.  
**Less ↔ More**
- [Brightness]** Adjusts the entire brightness of the video signals.  
**Less ↔ More**
- [Contrast]** Adjusts for easier viewing of dark pictures.  
**Less ↔ More**
- [Color]** Adjusts colour saturation.  
**Less ↔ More**
- [Tint]** Adjusts hue of skin colour.  
**Reddish ↔ Greenish**
- [Sharpness]** Adjusts picture sharpness.  
**Less ↔ More**

# Sound Adjustment

- 1 Press <MENU> and <▶> to display the [Sound] menu.

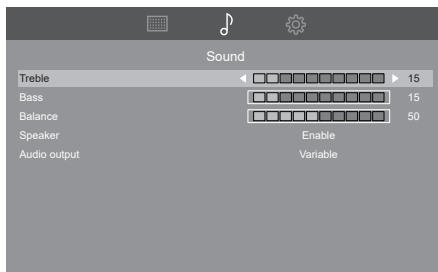

- 2 Select the item to adjust with <▲▼>.
  - Menu that cannot be adjusted is greyed out.
- 3 Adjust with <◀▶>.
- 4 Press <EXIT> to exit from adjust mode.

- [Treble]** Adjusts high pitch sounds.
- [Bass]** Adjusts low pitch sounds.
- [Balance]** Adjusts left and right volumes.
- [Speaker]** Internal speakers.

**[Enable]:**

Internal speakers enable.

**[Disable]:**

Internal speakers disable.

**[Audio output]**

Selects the volume of sound output from the audio output terminals.

**[Fixed]:**

Fix the sounds at the same level as 100 in [Variable].

**[Variable]:**

Adjusts the volume by using the <VOL +><VOL -> on the remote control or <+><-> on the unit.

# Setup menu

- 1 Press <MENU> and <▶> to display the [Setup] menu.

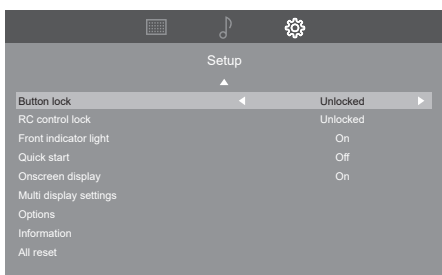
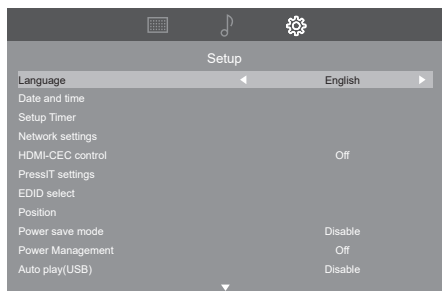

- 2 Select the item to set with <▲▼>.

- Menu that cannot be adjusted is greyed out. Adjustable menu changes depending on signal input and menu setting.

- 3 Set with <◀▶>.

- 4 Press <EXIT> to exit from adjust mode.

## ■ To return to the previous screen

Press <MENU>.

## Language

Select your preferred language.

Selectable languages

English  
Français  
Español  
日本語

## Date and time

Sets the date and time.

## Setup Timer

Sets the program to turn the power on with the specified video input and at the specified time, or to turn the power off at the specified time. Up to 7 programs can be set.

### Note

- Set the date and time correctly. (see page 37)
- Check periodically if the set date and time are correct.

[Setup Timer] submenu screen

- ① Select the program number to set the timer and press <ENTER>

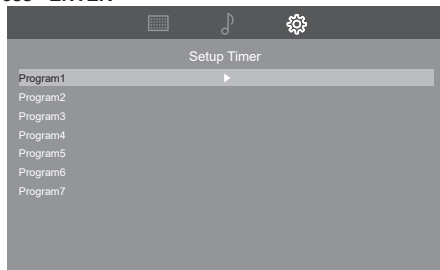

- ② Set the details of the timer.

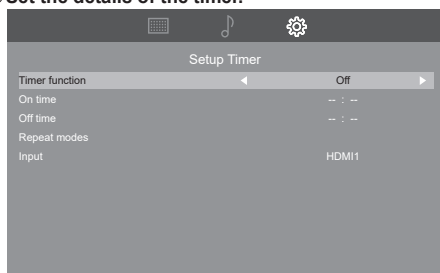

## ■ [Timer function]

### [On]:

The timer setting is enabled.

### [Off]:

The timer setting is disabled.

## ■ [On time]

Sets the time to turn the power on.

## ■ [Off time]

Sets the time to turn the power off.

## ■ [Repeat modes]

Select [Repeat modes] and press <ENTER> to display the repeat mode setting screen.

Select the day and press <MENU> to return to the previous screen.

### [No repeat]:

Executes the program only once. The setting is deleted after execution.

### [Every Sun] to [Every Sat]:

Executes the program on specified days.

Multiple days can be selected.

## ■ [Input]

Specifies the input when the power is turned by programs.

### Note

- When [On time] or [Off time] is not set, the display shows [--:--] (not set).
- When [On time] and [Off time] are set simultaneously, or when only [On time] is set, the power is turned on at the set time.
- [On time] and [Off time] can be set from 00:00 to 23:59 on the same date. [Off time] cannot be set before the time set for [On time].
- When the power is on and the active timer setting reaches the power-on time, the input will switch to the input set in [Input].
- When using multiple programs, specify [Off time] and [On time] at one-minute intervals or more. When power-off time is not necessary, set it to [--:--] (not set).

## Network settings

Selects the method with which to control the display from the computer.

[Network settings] submenu will be displayed.

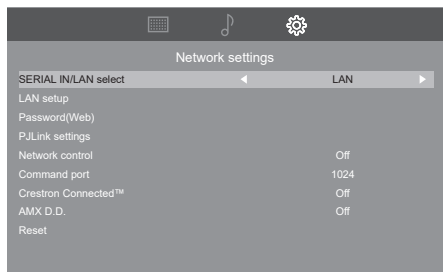

## ■ [SERIAL IN/LAN select]

RS-232C or network function is enable. To control the display via RS-232C, set [SERIAL IN/LAN select] to [SERIAL IN]. To control the display via network function, set to [LAN].

### Note

- You cannot use RS-232C and LAN control simultaneously.
- Since the network function is in preparation immediately after the power is turned on, some of the items may be grayed out and unselectable. In this case, those items will be displayed correctly by displaying the menu again after a while. To reduce the preparation time for the network function, it is effective to set [Quick start] to [On] or [Power save mode] to [Disable].

## ■ [LAN setup]

Controls via LAN using the LAN terminal.

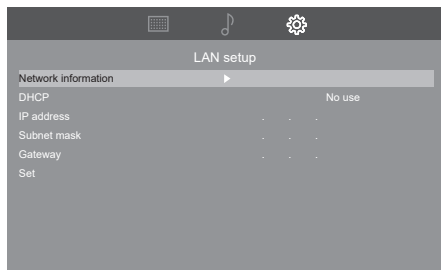

### [Network information]

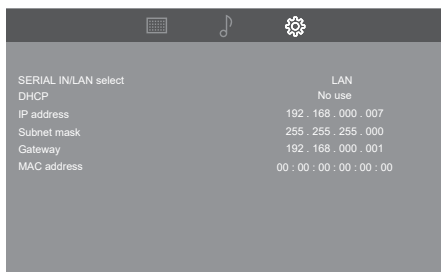

### [DHCP], [IP address], [Subnet mask], [Gateway]

① Press <◀▶> to set [Use] / [No use] of [DHCP].

When [No use] is selected, IP address and other settings can be set manually.

#### [DHCP]:

**[Use]: Use Dynamic IP address.**

**[No use]: Use Static IP address, Subnet mask, and Gateway.**

#### [IP address]:

Enter IP address when [DHCP] is [No use].

#### [Subnet mask]:

Enter Subnet mask when [DHCP] is [No use].

#### [Gateway]:

Enter Gateway address when [DHCP] is [No use].

### Note

- When [DHCP] is set to [Use], others will be displayed in grey.

## Entering numbers

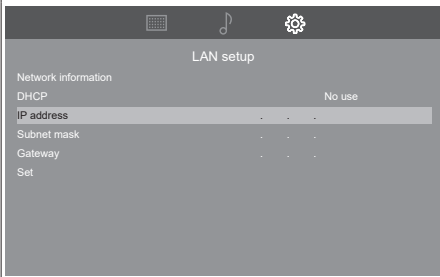

1. Select the address and press <ENTER>.
2. Select digits with the cursor buttons <◀/▶>.
3. Change numbers with the cursor buttons <▲/▼> and the numeric buttons <0-9>.
4. Press <ENTER>.

### ② Select [Set] and press <ENTER>.

Save the current network Setup.

#### Note

- To use a DHCP server, make sure the DHCP server is started.
- Contact your network administrator for details on [IP address], [Subnet mask] and [Gateway].
- Shipping condition  
[DHCP]: [Use]

## ■ [Password(Web)]

Selecting this item lets you access the web page of this unit. For details, refer to "Using Network Function". (see page 45)

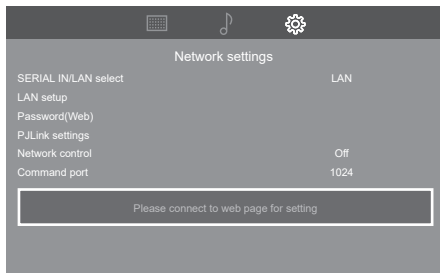

## ■ [PJLink settings]

Configure these settings to perform PJLink control.

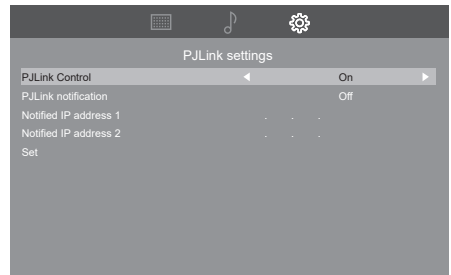

### [PJLink Control]

Set this item to perform communication using PJLink.

[Off]: Disables the PJLink control.

[On]: Enables the PJLink control.

### [PJLink notification]

Set this item to use the PJLink notification.

[Off]: Disables the notification.

[On]: Enables the notification.

### [Notified IP address 1], [Notified IP address 2]

Set the IP address of the PC where the status of this unit is notified.

### [Set]

Save the password set above on the display unit.

#### Note

- PJLink control cannot be performed if [Password(Web)] is not set at the time of purchase or after [All reset].

## ■ [Network control]

Set this item to control via the LAN terminal of this unit.

[Off]: Disables the control via the LAN terminal. (In this case, turning "OFF" the power (standby) using the remote control slightly reduces the power consumption.)

[On]: Performs LAN control via the LAN terminal. Turning "OFF" the power (standby) using the remote control lights up the power indicator in purple.

## ■ [Command port]

Set the port number to be used for [Network control].

- The setting range is 1024 to 65535.

## ■ [Crestron Connected™]

**MAIN version 1.500 or later, LAN version 1.50 or later**

When this function is set to [On], you can monitor and control this unit over the network using devices and application software provided by Crestron Electronics, Inc.

### Note

- Crestron Connected is a system developed by Crestron Electronics, Inc. that enables centralized management and control of various devices in multiple network-connected systems from a computer.
- For details of Crestron Connected, refer to the Crestron Electronics, Inc. website. <https://www.crestron.com>

## ■ [AMX D.D.]

Set whether to use AMX Device Discovery for detection.

[Off]: Disables detection using AMX Device Discovery.

[On]: Enables detection using AMX Device Discovery.

- For more details, visit the following website. <https://www.amx.com/>

### Note

- To set this item to [On], the [Password(Web)] setting is required.

## ■ [Reset]

Resets the values of [Network settings] items to the factory default settings.

### Note

- When configuring network settings again after executing [Reset], do so a short while later.

## HDMI-CEC control

Set for HDMI-CEC function.

For details of HDMI-CEC function, refer to "Using HDMI-CEC function". (see page 58)

### ■ [On]

When set to [On], the display will automatically switch to the appropriate HDMI input whenever an HDMI connected equipment is initially turned on and the Play mode is selected.

### ■ [Off]

Disables HDMI-CEC control.

### Note

- The HDMI CEC feature of connected HDMI CEC-compatible device must be turned on.

## PressIT settings

This menu configures the settings for wireless presentation system (PressIT) connection.

For details, refer to the operating instructions on the following support site.

(<https://docs.connect.panasonic.com/prodisplays/products/ty-wps2/>)

[PressIT settings] - submenu screen

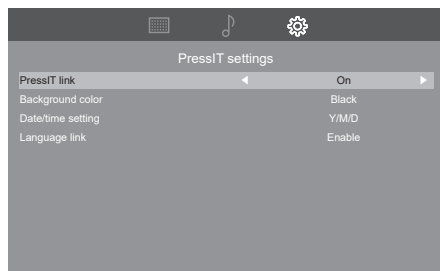

## EDID select

The menu is displayed in HDMI1, HDMI2 and HDMI3 inputs.

EDID data of each HDMI terminal is switched.

[EDID select] - submenu screen

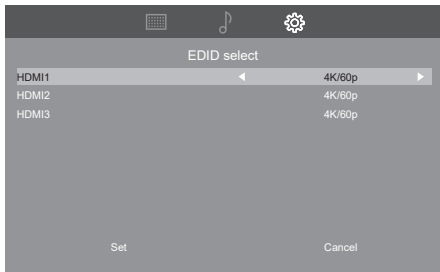

### ■ [4K/60p]

Sets EDID compatible with 4K video signals (Max. 4096 x 2160 dots, Max. vertical operation frequency 60 Hz).

### ■ [4K/30p]

Sets EDID compatible with 4K video signals (Max. 4096 x 2160 dots, Max. vertical operation frequency 30 Hz).

### ■ [Set]:

The specified contents are set. Restart the unit to apply the settings.

### ■ [Cancel]:

The specified contents are canceled.

#### Note

- The settings are not applied until the unit is restarted after [Set] is selected.

## Position

Adjusts the position.

[Position] - submenu screen

#### Note

- In some cases, noise appears outside the area picture is displayed, but it is not a malfunction of the image.
- It is only available for PC input.

[Position] - submenu screen



### ■ [Auto setup]

Sets the operational mode of the automatic position adjustment.

#### Note

- [Auto setup] may not work when a cropped or dark image is input. In such case, switch to a bright image with borders and other objects are clearly shown, and then try [Auto setup] again.

### ■ [Dot clock]

Periodic striped pattern interference (noise) may occur when a striped pattern is displayed. If this happens, adjust so that any such noise is minimized.

### ■ [Clock phase]

Adjusts sampling clock for applicable video.

Useful when small characters appear with low contrast and/or there are flickers at corners.

When using the adjustment pattern, make adjustments so that no horizontal stripe noise appears in it.

- It should be made only after [Dot clock] has been correctly set.

### ■ [H-position]

Adjusts the horizontal position of the image.

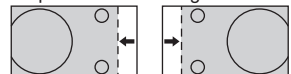

### ■ [V-position]

Adjusts the vertical position of the image.

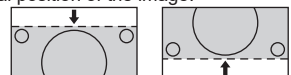

## ■ [Reset]

Resets the values of [Position] items to the factory default settings.

### Note

- In some cases, noise appears outside the area picture is displayed, but it is not a malfunction.
- It is only available for PC input.
- In the case that [Auto setup] cannot work well, [Auto setup] may work well to execute [Reset] before [Auto setup].

## Power save mode

When this function is set to [Disable], LAN control is possible in standby mode, but the power consumption is increased in standby mode.

When this function is set to [Enable], LAN control is impossible in standby mode, but the power consumption can be reduced in standby mode.

(Serial control enables the power to be turned on in standby mode regardless of [Disable] or [Enable] selected in the setting.)

## Power Management

This function turns the power off (standby) when video signals are not detected with HDMI or PC input, and turns the power on when video signals are detected.

### Note

- If the power is turned off (standby) using the remote control, this function is not activated.
- Video signals can be detected only with input terminals with which video signals are not detected at power-on. When the unit enters the standby state with this function, the power indicator lights in purple.

e.g. When video signals are not detected with HDMI1 input:

Power off (standby), Power indicator lights in purple.

When video signals are detected with HDMI1 input later:

Power on, Power indicator lights in blue.

## Auto play(USB)

Sets the type of file to be automatically played from a USB memory device.

### ■ [Disable]

Disables the Auto playback function.

### ■ [Photo]

Photos in a USB memory device can be played automatically. (\*.jpg file only)

### ■ [Video]

Video in a USB memory device can be played automatically. (\*.mp4 file only)

### Note

- Photos and video cannot be played automatically at the same time. (see page 55)

## Button lock

Disables the display buttons.

### ■ [Unlocked]

All the buttons on main unit can be used.

### ■ [Lock all]

All the buttons on main unit can not be used.

### ■ [Lock except volume]

Disabling all button operations on main unit except <+> and <->.

### ■ [Lock except power]

Disabling all button operations on main unit except <Power button (⏻/⏻)>.

### To cancel [Button lock]

- Press <Play (▶)> until "L" appears in the screen to disable [Button lock]. Before the "L" disappears, pressing the following sequence cursor buttons <▲▼◀▶>
- You can also disconnect the power plug from socket outlet and then reconnecting the power plug while pressing the <Power button (⏻/⏻) (Unit)> on the display.

## RC control lock

Disables the remote control buttons.

### ■ [Unlocked]

All the buttons on your remote control can be used.

### ■ [Lock all]

All the buttons on your remote control can not be used.

### ■ [Lock except volume]

Disabling all button operations on your remote control except <VOL +> and <VOL ->.

### ■ [Lock except power]

Disabling all button operations on your remote control except <POWER ON button (|)> / <STANDBY button(Ⓞ)>.

#### To cancel [RC control lock]

- Press <Play (▷)> until "L" appears in the screen to disable [RC control lock]. Before the "L" disappears, pressing the following sequence cursor buttons <▲▼◀▶>
- You can also disconnect the power plug from socket outlet and then reconnecting the power plug while pressing the <Power button (Ⓞ/|) (Unit)> on the display.

## Front indicator light

Enables / Disables the power LED.

## Quick start

This function quickly turns the power on at power-on.

### ■ [On]

Quickly turns the power on at power-on.

### ■ [Off]

Turns the power on in a usual manner at power-on.

#### Note

- When this function is set to [On], power consumption is increased in standby mode.

## Onscreen display

### MAIN version 1.500 or later

Enables or disables the on-screen displays for power-on status, input switching, and no-signal status.

[On]: Enables the displays.

[Off]: Disables the displays.

## Multi display settings

### MAIN version 1.500 or later

Set the screen display mode.

#### Note

- Set the input to something other than USB.

### 1. [Multi display settings]

### ■ [Multi screen display]

#### [Off]:

The display is not divided when enlarged.

#### [On]:

The display is divided when enlarged.

#### Note

- When this function is set to [On], aspect ratio cannot be used.

### 2. [Multi screen display]

1 to 5 displays can be aligned in horizontal direction and vertical direction respectively, and those displays are regarded as one group. The enlarged image is shown on the combined display.

[Multi display settings] - submenu screen  
([Multi screen display])

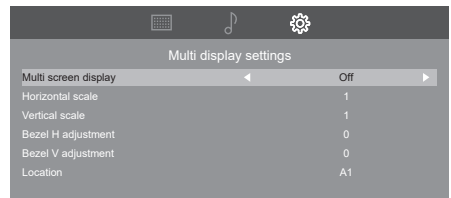

### ■ [Horizontal scale]

Set the horizontal scale in the multi screen display.

1 to 5

### ■ [Vertical scale]

Set the vertical scale in the multi screen display.

1 to 5

Example:

Multi-screen display with [Horizontal scale] [5] and [Vertical scale] [5] set

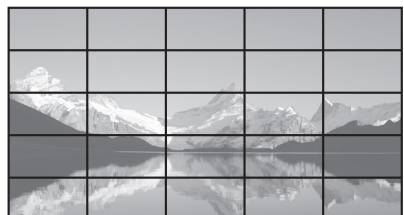

## ■ [Bezel H adjustment] / [Bezel V adjustment]

Adjust the area of image hidden in the joint horizontally and vertically respectively.

0 to 100

Display example:

Setting value: 0



Displays the entire image including the joint area. (Suitable when displaying character information on PC.)

Setting value: 100

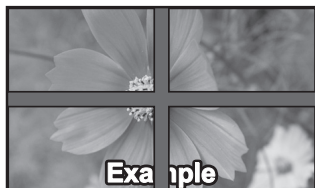

Does not display the image of the joint area. (Suitable when displaying motion pictures.)

## ■ [Location]

Assign screen positions on the multi-screen.

Example:

[Horizontal scale] [5], [Vertical scale] [5]

A1	A2	A3	A4	A5
B1	B2	B3	B4	B5
C1	C2	C3	C4	C5
D1	D2	D3	D4	D5
E1	E2	E3	E4	E5

Select from A1 - E5.

- The displayed content for setting changes according to the settings for the [Horizontal scale] and [Vertical scale].

## Options

MAIN version 1.500 or later

[Options] - submenu screen

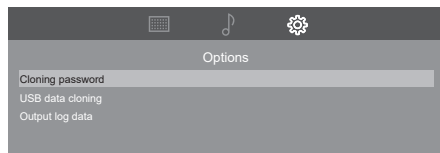

## ■ [Cloning password]

Sets the password for the cloning function.

For more detail of the settings, see "Changing the cloning password". (see page 60)

## ■ [USB data cloning]

Copies the data of a single display to multiple displays. For more detail of the settings, see "Using data cloning". (see page 58)

## ■ [Output log data]

Saves a log for servicing to the USB memory device.

## Information

Displays the display information.

## All reset

It is possible to reset the data to the factory settings.

# Using Network Function

This unit has a network function and you can control the display connected to the network using your computer.

## Necessary environment for computers to be connected

First of all, confirm your computer whether it has a wired LAN.

Before connecting the display to the computer, be sure to check the following settings.

### Check 1: About LAN cable

- Connect the cable properly.
- Use LAN cable that is compatible with category 5e or above.

### Check 2: Wired LAN settings

#### Computer with a built-in wired LAN function

- Switch on the wired LAN.

#### Computer without a built-in wired LAN function

- Check that your wired LAN adapter is recognized properly and it is switched on.
- Install the wired LAN adapter driver beforehand.

For details on how to install the driver, refer to the instructions accompanying the wired LAN adapter.

## Example of network connection

### Note

- When [Power save mode] is set to [Enable], the control is disabled in the standby mode.
- To use the network function, set each item in [Network settings] and make sure to select [LAN]. (see page 38)
- You cannot use RS-232C and LAN control simultaneously.
- Since the network function is in preparation immediately after the power is turned on, some of the items for network settings may be grayed out and unselectable, or network information of Information2 may not be displayed correctly. Those items will be displayed correctly by displaying the menu again after a while.

### LAN Terminal connection

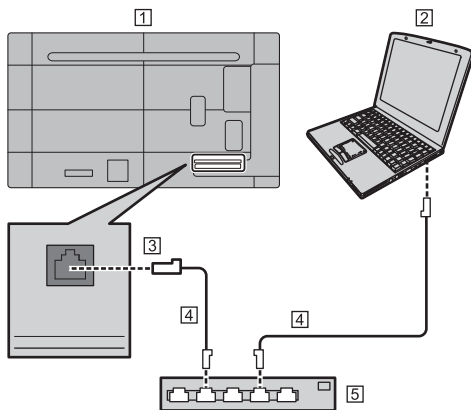

① Display (Back of the unit)

② PC

③ LAN terminal

④ LAN cable (commercially available)

⑤ Hub or broadband router

### Note

- For LAN cable, use shielded cable, otherwise picture noise may be caused.
- Make sure the broadband router or hub supports 10BASE-T / 100BASE-TX.
- Touching the LAN Terminal with a statically charged hand (body) may cause damage to the device due to its discharge.

Do not touch the LAN Terminal or the metal part of the LAN cable.

## Settings to connect to a LAN

### [Important]

The network environment when controlling via LAN is required to be physically isolated from the outside network or not illegally connected / controlled by unknown equipment with the Firewall.

The settings depend on the configuration of your LAN. For instructions on connection, consult your network administrator.

## To set on the Display

Set [SERIAL IN/LAN select] of [Network settings] on the [Setup] menu to [LAN], and then set the [LAN setup] options. (see page 38)

After setting each item, select [Set] and press <ENTER>.

### ■ Network information

Displays LAN setting information. (see page 38)

## Access from the web browser

To perform LAN control, connect to the network for the first time after purchase or after [All reset], display the web page of this unit on the PC browser, and be sure to set the password.

The setting on the web page is effective for 3 minutes after selecting [Network settings] - [LAN setup] - [Password(Web)].

When the validity period is expired, the connection is terminated, and setting on the web page and update of display contents will be unavailable. Select "Password(Web)" again for reconnection.

### ■ Access to the web page

The user name and password are necessary to access the web page.

User name: disadmin (fixed)

Initial password: @Panasonic

It is also necessary to set this password for the first time after purchase or after [All reset].

## 1 Connect this unit and PC to the network.

(see page 45)

## 2 Select [Network settings] - [LAN setup] - [Password(Web)].

(see page 39)

## 3 Start up the web browser on the PC.

## 4 Enter the IP address that has been set for [LAN setup] of this unit into the address bar on the web browser.

## 5 When the authentication screen is displayed, enter the user name and password.

Sign in to access this site

Authorisation required by https://192.168.1.100

Username

Password

Sign in Cancel

### Note

- When the web page of this product is accessed, a message of "Your connection is not private" may be displayed on the screen. In this case, click "Advanced settings" at the bottom of the screen, and click "Access \*\*\*.\*\*\*.\*\*\*.\*\*\* (IP address set on this unit)".
- Depending on the web browser to be used, displayed operations may change.

### MAIN version 1.500 or later

- When a password for accessing the web page has been set, you can access the page without selecting [Password(Web)] in [Network settings] - [LAN setup].

## 6 Set the password.

### Note

- When a password setting screen is displayed, set a password to access this web page (enter the same password twice for confirmation). A PJLink password can be set at the same time. The setting of a PJLink password can be skipped.

Web Network Settings

Web Site Name:

Web Site Password:

Web Site Confirmation Password:

Enable Web Site Password:

Enable PJLink Password:

Set

## ■ Network settings on the web page

Connect this unit and PC to the network, and configure the setting on the browser. Enter the current setting values respectively, and then set new values (enter the same password twice: the new password and password for confirmation).

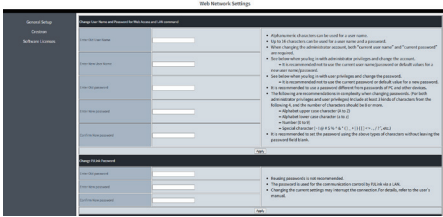

### Note

- The web page is displayed only in English.

### Password to restrict the access to the web page

Use a password to restrict the access to the web page. Change the password first.

- When [All reset] is executed, the password returns to the original value.
- The number of characters that can be used for a password is 8 characters or more and 16 characters or less.
- The following are recommendations when changing the password.

Include at least three types from the following four types of characters.

- 1) Alphabet uppercase character (A to Z)
- 2) Alphabet lowercase character (a to z)
- 3) Number (0 to 9)
- 4) Special character (~!@#\$\$%&\*()\_+{|[]}<>.,/?)

### PJLink security authentication

Use a password for PJLink security authentication. Change the password first.

- [All reset] settings will restore the password to the factory default.
- The maximum number of characters that can be used for a password is 32 characters.
- Recommended password

Number of characters: 8 to 32

Include at least 3 types of character from the following.

- 1) Alphabet uppercase character (A-Z)
- 2) Alphabet lowercase character (a-z)
- 3) Number (0-9)
- 4) Special character (~!@#\$\$%&\*()\_+{|[]}<>.,/?)

When using without authentication, leave the password blank.

### Note

- It is recommended that do not set the same password as the current password or the same value as the factory setting as the New password.
- For PJLink specifications, visit the Japan Business Machine and Information System Industries Association (JBMI) website:  
<https://pjlink.jbmi.or.jp/english/index.html>
- No member of the Panasonic Projector & Display Corporation or its affiliate companies will ever ask directly for your passwordnew  
Never divulge your password should you ever receive such a request.

### [Web secure setting]

When accessing the web control screen, set a method of communication between the PC and this unit.

[HTTPS] :

Use HTTPS (Hypertext Transfer Protocol Secure) encrypted by the SSL/TLS protocol.

[HTTP] :

Use http communication.

### Note

- When an http address is accessed with this item set to [HTTPS], the output is automatically redirected to the https address.
- When this setting is changed from [HTTPS] to [HTTP], the screen may not be displayed when the web control screen is operated or updated. In this case, erase cache of the web browser.



### [Command Protect]

Set an encryption algorithm for sending control commands.

[SHA-256] : Use the SHA-256 algorithm.

[MD5] :Use the MD5 algorithm.

### Note

- For the Command Protect setting, use an algorithm compliant with the hash algorithm of encrypted communication used in your command control tool, etc.
- Since encryption using MD5 may be deciphered, it is recommended to set [Command Protect] to [SHA-256], and use the encrypted communication using SHA-256 with higher security level.

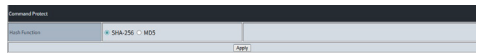

### [LAN setup]

Set a DNS server.

### [Software Licenses]

Clicking this item displays the license of the open source software used in this unit.

## ■ Settings for Crestron Connected

### MAIN version 1.500 or later, LAN version 1.50 or later

Configure the settings required to connect the Crestron system to the display, and the settings for monitoring and controlling the display using the Crestron system.

Set [Crestron Connected™] to [On] in [Network settings] to use this function.

### Crestron Settings

#### When using the Control System

Host Type: Select [Control System].

Use Secure Connection: Enable to use secure communication.

Verify Certificate: Enable to use certificate verification for secure communication.

IP Address: Enter the IP address of the device to connect to.

Room ID: Leave blank.

IPID: Enter the IP ID used to identify the device on the network.

Port: Displays the port number.  
Non-secure: 41794  
Secure: 41796

User Name: Enter the user name for connection authentication (up to 20 single-byte characters).

User Password: Enter the password for connection authentication (up to 20 single-byte characters).

Certificate: Configure this when using certificate verification for secure communication. Click [Upload file], select the certificate, and click [Upload].

Apply: Updates the settings.

#### When using the VC-4 software control platform

Host Type: Select [VC-4].

Use Secure Connection: Enable to use secure communication.

Verify Certificate: Enable to use certificate verification for secure communication.

IP Address: Enter the IP address of the device to connect to.

Room ID: Enter the ROOM ID used to identify the device on the network.

IPID: Enter the IP ID used to identify the device on the network.

Port: Displays the port number.  
Non-secure: 41794  
Secure: 41796

User Name: Enter the user name for connection authentication (up to 20 single-byte characters).

User Password: Enter the password for connection authentication (up to 20 single-byte characters).

Certificate: Configure this when using certificate verification for secure communication. Click [Upload file], select the certificate, and click [Upload].

Apply: Updates the settings.

#### Auto Discovery

Configure the waiting process for the discovery protocol.

Auto Discovery: Set to [Enable] to use Auto Discovery.

Apply: Updates the settings.

## XiO Cloud

Configure the setting to control devices using XiO Cloud.

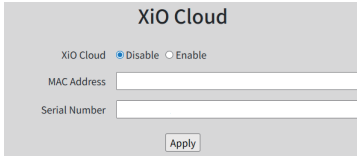

The screenshot shows a configuration panel titled "XiO Cloud". At the top, there is a radio button selection for "XiO Cloud" with "Disable" selected and "Enable" unselected. Below this are two text input fields: "MAC Address" and "Serial Number". At the bottom of the panel is an "Apply" button.

XiO Cloud: Set to [Enable] to use XiO Cloud.

MAC Address: Displays the MAC address.

Serial Number: Displays the serial number.

Apply: Updates the settings.

## Proxy

Configure the proxy server setting.

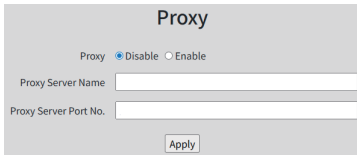

The screenshot shows a configuration panel titled "Proxy". At the top, there is a radio button selection for "Proxy" with "Disable" selected and "Enable" unselected. Below this are two text input fields: "Proxy Server Name" and "Proxy Server Port No.". At the bottom of the panel is an "Apply" button.

Proxy: Set to [Enable] to use a proxy server.

Proxy Server Name: Enter the proxy server name or IPv4 address.

Proxy Server Port No.: Enter the port number of proxy server.

Apply: Updates the settings.

## Command control

Network function of the unit can control the unit in the same way as serial control from a network.

### Supported commands

Commands used in the serial control are supported. (see page 24)

## Control Command via LAN

### Connection method

1 Obtain the display's IP address and the port number (Default is 1024), and request connection to the display.

The IP address and the port number can be obtained from the following menus.

- IP address:  
[Setup] → [Network settings] → [LAN setup]
- Port number:  
[Setup] → [Network settings] → [Command port]
- For more detail of the settings, see page 38.

2 Check the response from the display.

	Data part	Blank	Mode	Blank	Random number	Last terminal symbol
<b>Command example</b>	"NTCONTROL" (ASCII character string)	" " 0x20	"1" 0x31	" " 0x20	"ZZZZZZZZ" (ASCII code hex number)	(CR) 0x0d
<b>Data length</b>	9 bytes	1 byte	1 byte	1 byte	8 bytes	1 byte

- Mode: 1 = Protection mode in which [Command Protect] is set to [MD5]
- Mode: 2 = Protection mode in which [Command Protect] is set to [SHA-256]
- e.g.: Response in protection mode (Mode: 1) (The random number part is an indefinite value.)  
"NTCONTROL 1 23181e1e" (CR)

3 Hash the following data using the MD5 or SHA-256 algorithm, and generate a 32-byte (for MD5) or 64-byte (for SHA-256) hash value.

- "xxxxxx:yyyy:zzzzzzzz"

<b>xxxxxx</b>	Username to access the web page
<b>yyyyy</b>	Password to access the web page
<b>zzzzzzzz</b>	8-byte random number obtained in step 2

## Command transmission method

Transmit in the following command format

Transmitted data

	Header			Data part	Last terminal symbol
<b>Command example</b>	Hash value (See "Connection method" (page 50).)	"0" 0x30	"0" 0x30	Control command (ASCII character string)	(CR) 0x0d
<b>Data length</b>	32 bytes or 64 bytes	1 byte	1 byte	Undefined	1 byte

- e.g.: When the power "ON" command is sent  
"dbdd2dabd3d4d68c5dd970ec0c29fa6400PON" (CR)

Received data

	Header		Data part	Last terminal symbol
<b>Command example</b>	"0" 0x30	"0" 0x30	Control command (ASCII character string)	(CR) 0x0d
<b>Data length</b>	1 byte	1 byte	Undefined	1 byte

- e.g.: When the power "ON" command operates normally  
"00PON" (CR)

Error response

	Character string	Contents	Last terminal symbol
<b>Message</b>	"ERR1"	Undefined control command	(CR) 0x0d
	"ERR2"	Out of parameter range	
	"ERR3"	Busy status or reception invalid period	
	"ERR4"	Timeout or reception invalid period	
	"ERR5"	Data length invalid	
	"ERRA"	Mismatching of password	
<b>Data length</b>	4 bytes	—	1 byte

### Note

- With some of the commands, a part of character string of the transmitted data may not be included in the received data.
- Consult your local Panasonic dealer for detail instructions on command usage.

For more details, visit the following web site.

<https://docs.connect.panasonic.com/prodisplays/>

## PJLink protocol

The unit's Network function is compatible with PJLink Class 2. The following operations can be performed from a computer when PJLink protocol is used.

- Setting the Display
- Querying the Display status

### Note

- This unit is compliant with PJLink specifications Version 2.10. Using encrypted communication that uses SHA-256 hash algorithm is recommended in order to enhance the security level for the communication.

### Supported commands

The commands to control the unit with PJLink protocol are as follows.

Class	Command	Control
1	POWR	Power control 0: Standby 1: Power On
1	POWR ?	Power status query 0: Standby 1: Power On
1,2	INPT	Input switch * Refer to INST? parameters.
1,2	INPT ?	Input switch query * Refer to INST? parameters.
1	AVMT	Shutter control 10: Picture On (picture mute deactivated) 11: Picture Off (picture on mute) 20: Audio On (audio mute deactivated) 21: Audio Off (audio on mute) 30: Shutter mode Off (picture and audio mute deactivated) 31: Shutter mode On (picture and audio on mute)
1	AVMT ?	Shutter control query 11: Picture Off (picture on mute) 21: Audio Off (audio on mute) 30: Shutter mode Off (picture and audio mute deactivated) 31: Shutter mode On (picture and audio on mute)
1	ERST ?	Error status query Returns "000000".

Class	Command	Control
1,2	INST ?	Input switch list query 11: PC IN input (PC) 31: HDMI IN 1 input (HDMI1) 32: HDMI IN 2 input (HDMI2) 33: HDMI IN 3 input (HDMI3) 41: USB input (USB)
1	NAME ?	Display name query Returns "55EQ3W". (Example: 55-inch EQ3W model)
1	INF1 ?	Manufacturer name query Returns "Panasonic".
1	INF2 ?	Model name query Returns "55EQ3W". (Example: 55-inch EQ3W model)
1	INFO ?	Other information query Returns version number.
1	CLSS ?	Class information query Returns "2".
2	SNUM ?	Serial number query Returns version number.
2	SVER ?	Software version query Returns software version.
2	INNM ?	Input terminal name query Returns input terminal name. 11: PC 31: HDMI1 32: HDMI2 33: HDMI3 41: USB
2	IRES ?	Input signal resolution query Returns Input signal resolution.
2	RRES ?	Recommended resolution query Returns recommended resolution.
2	SVOL	Speaker volume 0: Turns down the volume. 1: Turns up the volume.
2	LKUP	Linkup notification Notifies the MAC address when PJLink communication becomes available.
2	POWR	Power state change notification Notifies the state when the power state has changed. 0: Standby 1: Power On
2	INPT	Input change notification Notifies the input after switching when the input has changed. * Refer to the parameters of the INST? command.

**Note**

Refer to the following table for error responses during communication.

Error message	
"ERR1"	: Undefined control command
"ERR2"	: Out of parameter range
"ERR3"	: Busy status or reception invalid period
"ERR4"	: Display failure

## Multi Monitoring & Control Software

This unit supports the early warning software "Multi Monitoring & Control Software" which monitors and controls devices (projectors or displays) connected to an intranet.

- For more details, visit the following web site.  
<https://docs.connect.panasonic.com/prodisplays/>

# Using “USB media file playback function”

It allows you to enjoy photo, music or video recorded on a USB memory device. You can also play Music file during Photo file display.

For information on USB memory device, see page 25.

## ■ Supported formats

The unit's media file playback function supports the formats below. Save immediately below root in USB memory.

### Still pictures

Codec	Extension	Format	Colour space	Size
JPEG	jpg/jpeg	Baseline	YUV, RGB,	Max 15360 x 8640

### Motion pictures (Motion picture files without audio cannot be played back.)

Media type	Extension	Container	Video				Profile
			Codec	Maximum resolution	Maximum frame rate	Maximum bit rate	
	mp4	MP4	HEVC/H.265	4096x2176	60	100 M	Main/Main10Profile, High Tier @ Level 5.1
	mp4	MP4	H.264	4096x2160	60	135 M	Main Profile and High Profile @ Level5.0
	mp4	MP4	MPEG4	1920x1080	30	40 M	Simple Profile, Advanced Simple and Profile@Level 5 GMC is not supported
	mpg	MPEG	MPEG1	1920x1080	30	20 M	Main Profile
	mpg	MPEG	MPEG2	1920x1080	30	20 M	Main Profile
	mpg	MPEG	MPEG4	1920x1080	30	40 M	Simple Profile, Advanced Simple and Profile@Level 5 GMC is not supported
	avi	AVI	MPEG2	1920x1080	30	20 M	MP@HL
	avi	AVI	MPEG4	1920x1080	30	40 M	Simple Profile, Advanced Simple and Profile@Level 5 GMC is not supported
	avi	AVI	H.264	4096x2160	60	135 M	Main Profile and High Profile @ Level5.0
	avi	Motion JPEG	JPEG	640x480		10 M	
avi	Motion JPEG	JPEG	640x480		10 M		

Audio		
Codec	Sampling rate	Bit rate
MP3	MPEG-1 Layer2	16 kHz – 48 kHz
	MPEG-1 Layer3	16 kHz – 48 kHz
	MPEG-2 Layer3	16 kHz – 48 kHz
LPCM	8 kHz – 48 kHz	64 Kbps – 1.5 Mbps
ADPCM	8 kHz – 48 kHz	384 Kbps

### Music files

Extension	Container	Codec	Sampling rate	Bit rate
mp3	MP3	MPEG-1 Layer2	16 kHz – 48 kHz	8 Kbps – 384 Kbps
		MPEG-1 Layer3		8 Kbps – 320 Kbps
		MPEG-2 Layer3		

#### Note

- Some files may not be played back even if they are in the above supported formats.
- If unsupported files are stored in a USB memory, operation may become slower.

## Play file

### Note

#### MAIN version earlier than 1.500

- Files are displayed/played according to the order you copy them to a USB memory device. Copy files to a USB memory device according to the order you want to play.

#### MAIN version 1.500 or later

- Files are played in file name order.

### ■ Select the media to be played

1. Insert the USB memory device for media file playback to the USB terminal on the side of the display.

### Note

- Depending on the type of a USB memory device, it may come in contact with the periphery such as a back cover, and cannot be attached. Use a USB memory device connectable to this unit.

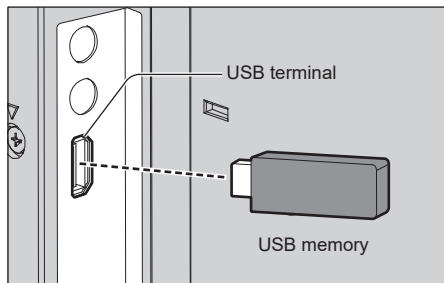

2. Change INPUT to [USB].
3. Select the media to be played with the cursor buttons <▲/▼>, and press <ENTER>.

### ■ Playing files

1. Displays the file to be played.  
Select the folder with the cursor buttons <▲▼> <◀▶> and press <ENTER> to show the files in the folder.
2. Select the file you want to play, and press <ENTER>.  
The file is selected.  
Multiple files can be selected. You can also select files in different folders.
3. Press <Play (▶)>.  
The selected files are played.

### Note

- The played aspect mode is [Normal].
- If you press <Play (▶)> without selecting a file, all the files in the folder will be played.
- Select [Number of staff lines] folder to return to the root folder, select [Horizontally ruled notebook size] folder to return to the next higher folder.
- The volume can be adjusted with the <VOL +> / <VOL -> and <MUTE> on the remote control.
- For operations during play, see page 56, 57.

### ■ To stop playing

Press <EXIT>.

## Auto playback

Photos or video in a USB memory device can be played automatically. (MAX 30 files)

### ■ Preparations

Prepare the files. Name the file to be played "001-030" such as "001.jpg" - "030.jpg".

1. Creates a folder named "AUTO\_PLAYBACK" in the root folder of a USB memory device and copy the files to be automatically played to the folder.
2. Store the prepared files in the [AUTO\_PLAYBACK] folder.

Select the type of file.

1. Press <MENU>, and select [Setup] with the cursor buttons <◀/▶>.
2. Select [Auto play(USB)] with the cursor buttons <▲/▼>.
3. Select the type of file with the cursor buttons <◀/▶>.

### ■ Auto playback of files

#### MAIN version earlier than 1.500

Connect the USB memory in advance. When you turn on the unit, playback starts automatically.

You can also connect the USB memory after turning on the unit. Playback starts automatically.

#### MAIN version 1.500 or later

Switch the input to USB and connect the USB memory in advance. When you turn on the unit, playback starts automatically.

You can also connect the USB memory in advance. When you switch the input to USB, playback starts automatically.

You can also connect the USB memory after turning on the unit. Playback starts automatically.

### Note

- Photos and video cannot be played automatically at the same time.
- For auto playback, files are played back in order of file names.
- Select playback time for photos from "Interval" on the operation bar.
- When motion pictures are played back in a row, a black screen is inserted between motion pictures for 1 to 2 seconds.
- During auto playback, only the button operations of <VOL +> / <VOL -> and <EXIT> are enabled.

### ■ To stop auto playing



Press <EXIT>.

## Playing the pictures

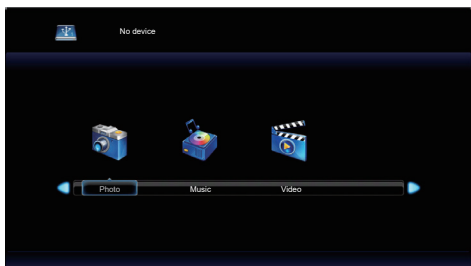
### 1 Press <◀/▶> to select the media to be played, and press <ENTER>.



### 2 Press <▲▼◀▶> to select the file you want to play.

-  : To play the selected file
-  : Selected the file. (Multiple files can be selected.)
-  : To return the media type select page.



### 3 Press <Play> ▸.

The selected picture will be displayed on the full screen.

## Operation bar

Press <ENTER> to display operation bar on the bottom of screen

Use <◀/▶> to select the following operations, and press <ENTER> for execution.

- [PLAY/PAUSE] To play the image slideshow.  
To pause the playing image.
- [Previous] To go to previous image.
- [Next] To go to next image.
- [STOP] To stop the playing image slideshow.
- [Repeat all] / [Repeat none] / [Repeat 1] [Repeat all] - Files in the folder or all selected files (select files and create a play list) are played repeatedly.  
[Repeat none] - After starting playing the files selected in the menu, each file in the same folder is played once in order until the last one.  
[Repeat 1] - The one file selected or checked in the menu is repeatedly played.
- [Random On] / [Random Off] When [Random On] is selected, all files are repeatedly played at random.
- [Music Off] / [Music On] Setting to [Music On], the photo and music files in the same folder are played at the same time.
- [Playlist] Show Playlist.
- [Info.] Show the file information.
- [Rotate] (Clockwise) Rotate the image 90 degrees clockwise temporarily.  
[Rotate] (Counter-Clockwise) Rotate the image 90 degrees Anti-clockwise temporarily.
- [Zoom in] To zoom-in the image.
- [Zoom out] To zoom-out the image.
- [Move] Select view area in zoomed.
- [Interval] Select Slideshow time.

## Playing the music / video

### 1 Press <◀/▶> to select the media to be played, and press <ENTER>.

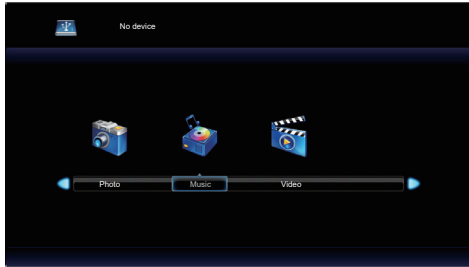

### 2 Press <▲▼◀▶> to select the file you want to play.

- : To play the selected file
- : Selected the file. (Multiple files can be selected.)
- : To return the media type select page.

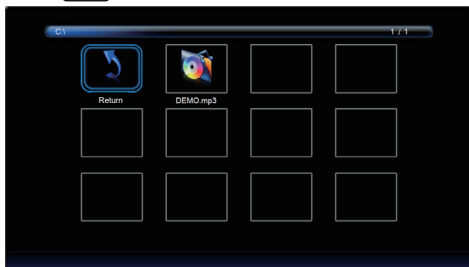

### 3 Press <Play> ▷.

The selected video will be displayed on the full screen.

#### Note

- The music icon is displayed on the screen for music playback.

#### Operation bar

Press <ENTER> to display operation bar on the bottom of screen

Use <◀/▶> to select the following operations, and press <ENTER> for execution.

- [PLAY/PAUSE] To play the music / video.  
To pause the playing image.
- [FB] To play the file fast backward.  
FB2X / FB4X / FB8X / FB16X /  
(motion picture only) FB32X
- [FF] To play the file fast forward.  
FF2X / FF4X / FF8X / FF16X /  
(motion picture only) FF32X

- [Previous] To go to previous the file. When playing video, press once to play from the beginning.
- [Next] To go to next file.
- [STOP] To stop the playing file.
- [Repeat all] / [Repeat none] / [Repeat 1] [Repeat all] -  
Files in the folder or all selected files (select files and create a play list) are played repeatedly.  
[Repeat none] -  
After starting playing the files selected in the menu, each file in the same folder is played once in order until the last one.  
[Repeat 1] -  
The one file selected or checked in the menu is repeatedly played.
- [Random On] / [Random Off] When [Random On] is selected, all files are repeatedly played at random.
- [Set A] / [Set B] / [None] [Set A] -  
Set the interval of the start point.  
[Set B] - Set the interval of the end point.
- [Playlist] Show Playlist.
- [Info.] Show the file information.

You can also operate the file by using the navigation keys <◀◀, II, ▶, ▶▶> and the cursor buttons <◀/▶> on the remote control.

# Using HDMI-CEC function

The HDMI-CEC function enables the remote control of this unit alone to operate the basics of HDMI-CEC compatible devices by the interlocking control between this unit and such devices. Also, this function enables the remote control (or main unit's buttons) of a HDMI-CEC compatible device alone to turn on/off this unit and switch input.

## Connection

Connect the HDMI-CEC compatible device to HDMI IN 1, HDMI IN 2 or HDMI IN 3 terminal.

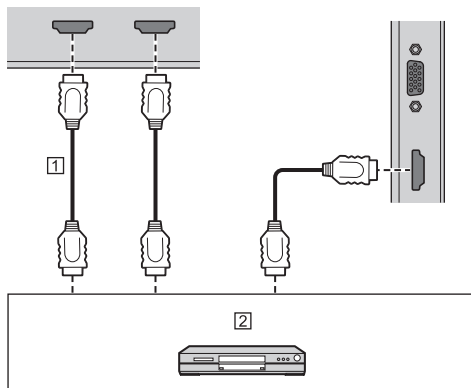

① HDMI cable (commercially available)

② DVD Recorder / DVD Player, Blu-ray Recorder / Blu-ray Player

## Setting

- ① Make the setting on the connected device (HDMI-CEC compatible device) so this function can operate.
- ② Set [HDMI-CEC control] to [PressIT settings]. (see page 40)
- ③ Turn on all the devices, and turn this unit off and on. Then check if images can be seen correctly with HDMI1, HDMI2 or HDMI3 input.

# Using data cloning

## MAIN version 1.500 or later

Menu settings and adjusted values of a single display can be copied to multiple displays using a USB memory.

### Note

- If the sizes of the displays are different, the cloning function does not operate. Use the common sized displays.
- The cloning password is the one set for [Cloning password].
- The initial password in the factory default state is [0000].

## ■ Data that can be copied

Settings and set values of [Picture], [Sound] and [Setup] menus

- The following data cannot be copied. Setting is required for each display.  
[Setup] - [Date and time]  
[Setup] - [Network settings]  
[Setup] - [Options]  
The setting contents on the web page

## Copying the display data to the USB memory

- 1 Insert the USB memory device to the USB terminal on the side of the display.

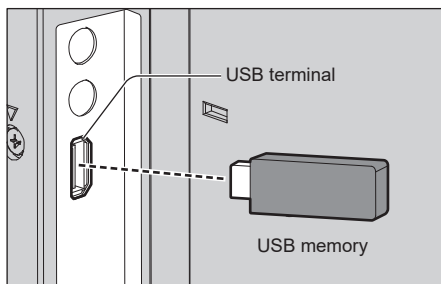

### Note

- Depending on the type of a USB memory device, it may come in contact with the periphery such as a back cover, and cannot be attached. Use a USB memory device connectable to this unit.

- 2 Display [Setup] menu screen pressing <MENU> and ►.

**3 Select [Options] with ▲ ▼ and press <ENTER>.**

The following display appears.

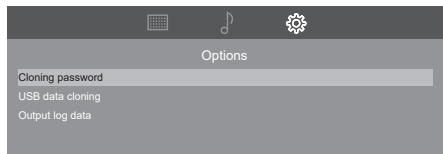

**4 Select [USB data cloning] with ▲ ▼ and press <ENTER>.**

[Cloning password] screen is displayed.

**5 Enter the cloning password using the numeric buttons <0 - 9>.**

The copy type selection screen is displayed.

**6 Select [Display → USB memory] with ▲ ▼ and press <ENTER>.**



**7 Select [Yes] with ◀ ▶ and press <ENTER>.**

Data copy to the USB memory starts.

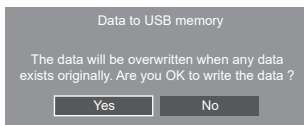

The following message is displayed after data copy has finished.

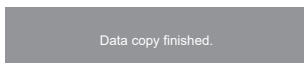

**8 After data copy has finished, remove the USB memory device from the USB terminal.**

## Copying (cloning) the USB memory data to the display

**1 Insert the USB memory device, which the data has been copied, to the USB terminal of the display for data copy (same as the step 1 on page 58).**

**2 Display [Setup] menu screen pressing <MENU> and ▶.**

**3 Select [Options] with ▲ ▼ and press <ENTER>.**

The following display appears.

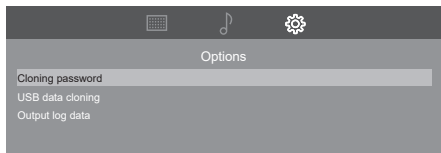

**4 Select [USB data cloning] with ▲ ▼ and press <ENTER>.**

[Cloning password] screen is displayed.

**5 Enter the cloning password using the numeric buttons <0 - 9>.**

The copy type selection screen is displayed.

**6 Select [USB memory → Display] with ▲ ▼ and press <ENTER>.**



**7 Select [Yes] with ◀ ▶ and press <ENTER>.**

Data cloning to the display starts.

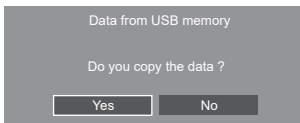

The following message is displayed after data cloning has finished.

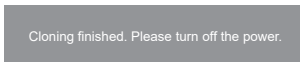

**8 After data cloning has finished, remove the USB memory device from the USB terminal.**

- Turn off the power to this unit, and then turn the power on. Or remove the power plug from the outlet once, wait for 30 seconds or more, and then insert the power plug.

The cloned content is applied to the display.

## Changing the cloning password

Changes the cloning password required to use the cloning function.

- Display [Setup] menu screen pressing <MENU> and **▶**.
- Select [Options] with **▲ ▼** and press <ENTER>.

The following display appears.

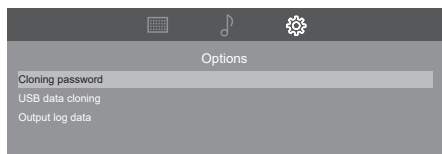

- Select [Cloning password] with **▲ ▼** and press <ENTER>.

[Cloning password] screen is displayed.

- Enter the current cloning password using the numeric buttons <0–9>.
- Enter a new cloning password using the numeric buttons <0–9>.
- Re-enter the new cloning password for confirmation using the numeric buttons <0–9>.

### Note

- The initial password in the factory default state is [0000].
- Change the password periodically, and set one which is difficult to guess.

## Software on this unit

The availability of functions described in these operating instructions differs depending on the software version.

These functions cannot be used in the following versions.

### MAIN version earlier than 1.500

- Onscreen display
- Multi display settings
- USB data cloning
- Output log data

### MAIN version earlier than 1.500, LAN version earlier than 1.50

- Crestron Connected™

The software version can be checked in [Setup]-[Information]. (see page 44)

# Preset Signals

This unit can display the video signals shown in the table below.

- The contents of HDMI signal in the Plug and Play-supported signal column are as follows.  
1: 4K/60p, 2: 4K/30p

Corresponding signal	Resolution (Dot)	Scanning frequency		Dot clock frequency (MHz)	Format*2	Plug and Play-supported signal*4		
		Horizontal (kHz)	Vertical (Hz)			HDMI		PC*5
						EDID 1	EDID 2	
480/60i	720 (1 440) x 480i*1	15.73	59.94	27.00	H	○	○	—
576/50i	720 (1 440) x 576i*1	15.63	50.00	27.00	H	○	○	—
480/60p	720 x 480	31.47	59.94	27.00	H	○	○	—
576/50p	720 x 576	31.25	50.00	27.00	H	○	○	—
720/60p	1 280 x 720	45.00	60.00	74.25	H	○	○	—
720/50p	1 280 x 720	37.50	50.00	74.25	H	○	○	—
1080/60i	1 920 x 1 080i	33.75	60.00	74.25	H	○	○	—
1080/50i	1 920 x 1 080i	28.13	50.00	74.25	H	○	○	—
1080/24p	1 920 x 1 080	27.00	24.00	74.25	H	○	○	—
1080/25p	1 920 x 1 080	28.13	25.00	74.25	H	○	○	—
1080/30p	1 920 x 1 080	33.75	30.00	74.25	H	○	○	—
1080/60p	1 920 x 1 080	67.50	60.00	148.50	H	○	○	—
1080/50p	1 920 x 1 080	56.25	50.00	148.50	H	○	○	—
3840 x 2160/24p	3 840 x 2 160	54.00	24.00	297.00	H	○	○	—
3840 x 2160/25p	3 840 x 2 160	56.25	25.00	297.00	H	○	○	—
3840 x 2160/30p	3 840 x 2 160	67.50	30.00	297.00	H	○	○	—
3840 x 2160/60p	3 840 x 2 160	135.00	60.00	594.00	H	○	—	—
3840 x 2160/50p	3 840 x 2 160	112.50	50.00	594.00	H	○	—	—
4096 x 2160/24p	4 096 x 2 160	54.00	24.00	297.00	H	○	○	—
4096 x 2160/25p	4 096 x 2 160	56.25	25.00	297.00	H	○	○	—
4096 x 2160/30p	4 096 x 2 160	67.50	30.00	297.00	H	○	○	—
4096 x 2160/60p	4 096 x 2 160	135.00	60.00	594.00	H	○	—	—
4096 x 2160/50p	4 096 x 2 160	112.50	50.00	594.00	H	○	—	—
640 x 480/60	640 x 480	31.47	59.94	25.18	R/H	○	○	○
800 x 600/60	800 x 600	37.88	60.32	40.00	R/H	○	○	○
1024 x 768/60	1 024 x 768	48.36	60.00	65.00	R/H	○	○	○
1280 x 720/60	1 280 x 720	44.76	60.00	74.48	R/H	○	○	○
1280 x 800/60	1 280 x 800	49.70	59.81	83.50	R/H	○	○	○
1280 x 960/60	1 280 x 960	60.00	60.00	108.00	H	○	○	—
1280 x 1024/60	1 280 x 1 024	63.98	60.02	108.00	R/H	○	○	○
1280 x 1024/75	1 280 x 1 024	79.98	75.02	135.00	R/H	○	○	○
1360 x 768/60	1 360 x 768	47.71	60.02	85.50	H	—	○	—
1400 x 1050/60	1 400 x 1 050	65.32	59.98	121.75	H	○	○	—
1440 x 900/60	1 440 x 900	55.94	59.89	106.50	R/H	○	○	○
1600 x 900/60	1 600 x 900*3	60.00	60.00	108.00	H	○	○	—
1600 x 1200/60	1 600 x 1 200	75.00	60.00	162.00	R/H	○	○	○
1680 x 1050/60	1 680 x 1 050	65.29	59.95	146.25	H	○	○	—
1920 x 1080/60	1 920 x 1 080	67.50	60.00	148.50	R/H	○	○	○
1920 x 1200/60	1 920 x 1 200*3	74.04	59.95	154.00	R/H	○	○	○
720 x 400/70	720 x 400	31.50	70.00	28.30	R/H	○	○	○

\*1: Pixel-Repetition signal (dot clock frequency 27.0 MHz) only

\*2: Signals to represent formats are as follows.

R: D-sub RGB (PC IN)

H: HDMI (HDMI IN 1, HDMI IN 2, HDMI IN 3)

\*3: Based on VESA CVT-RB (Reduced Blanking) standard

\*4: Signals with ◦ in the Plug and Play-supported signal column are the ones written in EDID (Extended Display Identification Data) of this unit.

For signals without ◦ in the Plug and Play-supported signal column, resolutions may not be selected on the PC side even if this unit supports those signals.











\*5: The sync signal only supports HD/VD signal input.

**Note**

- An auto detected signal format may be differently displayed from the actual input signal.
- [ i ] shown after the number of dots of resolution means the interlace signal.

# Troubleshooting

Before you call for service, determine the symptoms and make a few simple checks as shown below.

Symptoms		Check
Picture	Sound	
 Interference	 Noisy Sound	Electrical Appliances Cars / Motorcycles Fluorescent light
 Normal Picture	 No Sound	Volume (Check whether the mute function has been activated on the remote control.) Make sure the volume is not set to minimum.
 No Picture	 No Sound	Not plugged into AC outlet Not switched on Picture and Brightness/Volume setting (Check by pressing the POWER ON ( I ) button or STANDBY (⏻) button.)
 No Picture	 Normal Sound	If a signal with a non-applicable colour system format, or frequency is input, only the input terminal indication is displayed.
 No Colour	 Normal Sound	Colour controls set at minimum level (see page 35)
A display error such as "no picture" occurs, or remote control operation is suddenly disabled.		Load noises from outside may be interfering with normal operation. Turn off the power and turn it on after waiting at least 5 seconds, and then check the operation.
The screen turns off automatically.		Check the settings of [Power Management] may be set to [On]. (see page 42)
Power indicator is blinking in orange.		Temperature error (high temperature) has been detected. Review the surrounding environment.
No remote control operations can be performed.		Are the batteries inserted with polarity (+,-) aligned? (see page 15) Are the batteries exhausted? Point the remote control unit toward the Display's remote control sensor. (see page 27) Check whether the option other than [Unlocked] is selected in [RC control lock]. (see page 43)
No buttons on the unit operations can be performed.		Check whether the option other than [Unlocked] is selected in [Button lock]. (see page 42)
Unstable video		The signal may be incompatible. Try the automatic screen adjustment when PC input.
There are areas at the top and bottom of the screen where picture is not displayed.		When using a video software program (such as a cinema size program) with a screen wider than one in the 16:9 mode, blank areas separate from the images are formed at the top and bottom of the screen.
Parts of the unit become hot.		Even when the temperature of parts of the front, top and rear panels has risen, these temperature rises will not pose any problems in terms of performance or quality.

Symptoms	Check
The image from the HDMI input is abnormal.	<p>Check the HDMI cable support 4K, and whether compliant of HDMI standard.</p> <p>Check the input signal compatible with this Display. (see page 61 - 62)</p> <p>To set [EDID select] to [4K/30p] when the connected device does not support 4K.</p>
The image from PC input is abnormal.	<p>Check the PC setting correct.</p> <p>Check the input signal compatible with this Display. (see page 61 - 62)</p>
The Serial commands is uncontrollable.	<p>Check that [SERIAL IN/LAN select] is selected [SERIAL IN]. (see page 38)</p> <p>Check whether the connection has been made properly. (see page 23)</p>
The LAN is uncontrollable.	<p>Check that [SERIAL IN/LAN select] is selected [LAN]. (see page 38)</p> <p>Check that the connection has been made properly. (see page 45)</p> <p>Check that [LAN setup] is set properly. (see page 38)</p> <p>Check that the LAN control to be used is correctly configured in [Network settings] and in the network settings on the web page. (see page 38)</p> <p>Even when [Quick start] is set to [On], if there is an AC power interruption such as a power failure, it will take time after startup before LAN control becomes available. (see page 43)</p>
The unit is not turned on even if the power ON command is sent with the LAN control.	<p>If the [Power save mode] is set to [Enable], set it to [Disable]. (see page 42)</p>
Audio is not output immediately after the content begins to be played.	<p>When using content that plays audio in zero second after the playback starts, the audio immediately after the playback starts may not be output depending on the equipment to be used. This symptom may be improved by replacing the playback equipment or delaying the start of audio playback on the content side by 300 ms.</p>

# Specifications

## Model No.

86-inch model : TH-86EQ3W

75-inch model : TH-75EQ3W

65-inch model : TH-65EQ3W

55-inch model : TH-55EQ3W

50-inch model : TH-50EQ3W

43-inch model : TH-43EQ3W

## Power Supply

86-inch model

110 – 240 V ~ (110 – 240 V alternating current),  
50/60 Hz, 4.5 – 2.2 A

75-inch model

110 – 240 V ~ (110 – 240 V alternating current),  
50/60 Hz, 2.9 – 1.4 A

65-inch model

110 – 240 V ~ (110 – 240 V alternating current),  
50/60 Hz, 2.5 – 1.3 A

55-inch model

110 – 240 V ~ (110 – 240 V alternating current),  
50/60 Hz, 1.9 – 1.0 A

50-inch model

110 – 240 V ~ (110 – 240 V alternating current),  
50/60 Hz, 1.6 – 0.8 A

43-inch model

110 – 240 V ~ (110 – 240 V alternating current),  
50/60 Hz, 1.3 – 0.7 A

## Power Consumption\*1

86-inch model

336 W

75-inch model

217 W

65-inch model

184 W

55-inch model

142 W

50-inch model

119 W

43-inch model

93 W

## Stand-by condition

0.5 W

## LCD Display panel

86-inch model

86-inch ADS panel (Direct LED backlight),  
16:9 aspect ratio

75-inch model

75-inch ADS panel (Direct LED backlight),  
16:9 aspect ratio

65-inch model

65-inch ADS panel (Direct LED backlight),  
16:9 aspect ratio

55-inch model

55-inch VA panel (Direct LED backlight),  
16:9 aspect ratio

50-inch model

50-inch VA panel (Direct LED backlight),  
16:9 aspect ratio

43-inch model

43-inch ADS panel (Direct LED backlight),  
16:9 aspect ratio

## Screen size

86-inch model

1 895.0 mm (W) × 1 065.9 mm (H) × 2 174.2 mm  
(diagonal) / 74.60" (W) × 41.96" (H) × 85.60" (diagonal)

75-inch model

1 649.6 mm (W) × 927.9 mm (H) × 1 892.7 mm  
(diagonal) / 64.94" (W) × 36.53" (H) × 74.51" (diagonal)

65-inch model

1 428.4 mm (W) × 803.5 mm (H) × 1 638.9 mm  
(diagonal) / 56.23" (W) × 31.63" (H) × 64.52" (diagonal)

55-inch model

1 209.6 mm (W) × 680.4 mm (H) × 1 387.8 mm  
(diagonal) / 47.62" (W) × 26.78" (H) × 54.63" (diagonal)

50-inch model

1 095.8 mm (W) × 616.4 mm (H) × 1 257.3 mm  
(diagonal) / 43.14" (W) × 24.26" (H) × 49.50" (diagonal)

43-inch model

941.1 mm (W) × 529.4 mm (H) × 1 079.8 mm  
(diagonal) / 37.05" (W) × 20.84" (H) × 42.51" (diagonal)

## No. of pixels

8 294 400

(3 840 (Horizontal) × 2 160 (Vertical))

## Dimensions (W × H × D)

---

### 86-inch model

1 929 mm × 1 100 mm × 96 mm  
(excluding handles: 70 mm) /  
75.95" × 43.31" × 3.76"  
(excluding handles: 2.74")

### 75-inch model

1 684 mm × 962 mm × 96 mm  
(excluding handles: 70 mm) /  
66.28" × 37.87" × 3.76"  
(excluding handles: 2.74")

### 65-inch model

1 463 mm × 838 mm × 94 mm  
(excluding handles: 69 mm) /  
57.58" × 32.97" × 3.68"  
(excluding handles: 2.72")

### 55-inch model

1 242 mm × 713 mm × 66 mm /  
48.89" × 28.06" × 2.60"

### 50-inch model

1 129 mm × 649 mm × 66 mm /  
44.43" × 25.56" × 2.60"

### 43-inch model

973 mm × 562 mm × 65 mm /  
38.31" × 22.10" × 2.56"

## Mass

---

### 86-inch model

Approx. 46.0 kg / 101.5 lbs net

### 75-inch model

Approx. 35.6 kg / 78.5 lbs net

### 65-inch model

Approx. 27.1 kg / 59.8 lbs net

### 55-inch model

Approx. 15.6 kg / 34.4 lbs net

### 50-inch model

Approx. 13.5 kg / 29.8 lbs net

### 43-inch model

Approx. 10.7 kg / 23.6 lbs net

## Operating condition

---

### Temperature

0 °C – 40 °C (32 °F – 104 °F)\*2

### Humidity

20 % – 80 % (no condensation)

## Operating Time

---

18 hours/day

## Connection terminals

---

### HDMI IN 1

### HDMI IN 2

### HDMI IN 3

TYPE A Connector\*3 × 3

Audio signal:

Linear PCM (sampling frequencies: 48 kHz,  
44.1 kHz, 32 kHz)

---

### AUDIO IN

Stereo mini jack (M3) × 1, 0.5 Vrms

---

### PC IN

Mini D-sub 15 Pin (Compatible with DDC2B) × 1

---

### AUDIO OUT

RCA jack, 0.5 Vrms

Output: Variable (-∞ – 0 dB)

(1 kHz 0 dB input, 10 kΩ load)

---

### SERIAL IN

External Control Terminal

D-sub 9 Pin × 1:

RS-232C compatible

---

### LAN

Communication method:

RJ45, 10BASE-T / 100BASE-TX

---

### USB

USB connector × 1, TYPE A

DC 5V / 2.0 A

## Sound

---

### Speakers

φ 30 mm × 2 × 2 pieces

### Audio Output

20 W [10 W + 10 W] (10 % THD)

## Remote Control Transmitter

---

### Power source

DC 3 V (battery (AAA/R03/LR03 type) × 2)

### Operating range

Approx. 7 m (22.9 ft)

(when operated directly in front of remote control sensor)

### Mass

Approx. 91 g / 3.21 oz (including batteries)

### Dimensions (W × H × D)

48 mm × 27 mm × 190 mm / 1.89" × 1.06" × 7.48"

---

\*1: Shipping condition

\*2: Environmental temperature to use this unit at high altitudes (1 400 m (4 593 ft) and higher and below 2 800 m (9 186 ft) above sea level): 0 °C to 35 °C (32 °F to 95 °F)

\*3: VIERA LINK is not supported.

### Note

- Design and specifications are subject to change without notice. Mass and dimensions shown are approximate.

# Software License

---

This product incorporates the following software:

- (1) the software developed independently by or for Panasonic Projector & Display Corporation,
- (2) the software owned by third party and licensed to Panasonic Projector & Display Corporation,
- (3) the software licensed under the GNU General Public License, Version 2.0 (GPL V2.0),
- (4) the software licensed under the GNU LESSER General Public License, Version 2.1 (LGPL V2.1), and/or
- (5) open source software other than the software licensed under the GPL V2.0 and/or LGPL V2.1.

The software categorized as (3) - (5) are distributed in the hope that it will be useful, but WITHOUT ANY WARRANTY, without even the implied warranty of MERCHANTABILITY or FITNESS FOR A PARTICULAR PURPOSE.

At least three (3) years from delivery of this product, Panasonic Projector & Display Corporation will give to any third party who contacts us at the contact information provided below, for a charge no more than our cost of physically performing source code distribution, a complete machine-readable copy of the corresponding source code covered under GPL V2.0, LGPL V2.1 or the other licenses with the obligation to do so, as well as the respective copyright notice thereof.

Contact Information:

oss-cd-request@gg.jp.panasonic.com

## Notice about AVC/VC-1/MPEG-4

This product is licensed under the AVC Patent Portfolio License, VC-1 Patent Portfolio License and MPEG-4 Visual Patent Portfolio License for the personal use of a consumer or other uses in which it does not receive remuneration to (i) encode video in compliance with the AVC Standard, VC-1 Standard and MPEG-4 Visual Standard ("AVC/VC-1/MPEG-4 Video") and/or (ii) decode AVC/VC-1/MPEG-4 Video that was encoded by a consumer engaged in a personal activity and/or was obtained from a video provider licensed to provide AVC/VC-1/MPEG-4 Video. No license is granted or shall be implied for any other use. Additional information may be obtained from MPEG LA, LLC. See <http://www.mpegla.com>.

## Disposal of Old Equipment and Batteries

### Only for European Union and countries with recycling systems



These symbols on the products, packaging, and/or accompanying documents mean that used electrical and electronic products and batteries must not be mixed with general household waste. For proper treatment, recovery and recycling of old products and used batteries, please take them to applicable collection points in accordance with your national legislation.

By disposing of them correctly, you will help to save valuable resources and prevent any potential negative effects on human health and the environment.

For more information about collection and recycling, please contact your local authority. Penalties may be applicable for incorrect disposal of this waste, in accordance with national legislation.



#### Note for the battery symbol (bottom symbol)

This symbol might be used in combination with a chemical symbol. In this case it complies with the requirement set by the Directive for the chemical involved.

### Notice (U.S.A. only)

To dispose of your product, please recycle in accordance with local environmental regulations. For further recycling please visit

<https://shop.panasonic.com/recycle>

### Customer's Record

The model number and serial number of this product may be found on its rear panel. You should note this serial number in the space provided below and retain this book, plus your purchase receipt, as a permanent record of your purchase to aid in identification in the event of theft or loss, and for Warranty Service purposes.

**Model Number**

**Serial Number**

### Panasonic Projector & Display Americas LLC

Two Riverfront Plaza, Newark, New Jersey 07102

TEL: +1-201-348-7000

Manufactured by:

Panasonic Projector & Display Corporation

2-15 Matsuba-cho, Kadoma City, Osaka 571-8503, Japan

Importer:

Panasonic Connect Europe GmbH

Hagenauer Strasse 43, 65203 Wiesbaden, Germany

Authorized Representative in EU:

Panasonic Connect Europe GmbH

Panasonic Testing Centre

Winsbergring 15, 22525 Hamburg, Germany

Importer for UK:

Panasonic Connect UK,

a branch of Panasonic Connect Europe GmbH,

Maxis 2, Western Road, Bracknell, Berkshire, RG12 1RT

## Panasonic Projector & Display Corporation

2-15 Matsuba-cho, Kadoma City, Osaka 571-8503, Japan

Web Site : <https://docs.connect.panasonic.com/prodisplays>

© Panasonic Projector & Display Corporation 2026

English