



Product specification (design and specification subject to change without notice)

■ DISPLAY PANEL

Screen Size (Diagonal)	54.63-inch (1387.8 mm)
Panel type / Backlight	VA Panel / Direct-LED
Aspect ratio	16:9
Effective Display Area (W x H)	47.62" x 26.78" (1209.6 x 680.4 mm)
Resolution (H x V)	3840 x 2160
Brightness (Typ)	500 cd/m ²
Contrast Ratio (Typ)	5000:1
Dynamic Contrast Ratio	50000:1
Max. Display Colors	Approx. 1.07 Billion
Response Time (Typ)	6.5 ms
Viewing Angle (Horizontal / Vertical)	178° / 178° (CR>10)
Panel Life Time ¹ (Typ)	Approx. 50000 hours
Panel Surface Treatment	Anti-glare type (Haze 25%)

1 When the panel lifetime is at 50% of the brightness under the condition of 25 degrees Celsius (+/- 2 degrees Celsius).

2 The LCD panel is made with high-precision technology, but there may be dots that are always lit or dots that are not lit on the display screen. This is not a malfunction, so note that. The percentage of missing dots in this product is 0.00005% or less. (Calculated in sub-pixel units according to ISO9241-307 standards.)

■ CONNECTION TERMINAL

HDMI IN	HDMI™ Type A Connector x 3	Linear PCM (Sampling frequency: 48 kHz/44.1 kHz/32 kHz) Compatible with HDCP 2.2
PC IN	Mini D-Sub 15-pin (DDC2B) x 1	RGB : without sync 0.7 V [p-p] (75 Ω) HD/VD : TTL (high impedance)
SERIAL IN	External control terminal D-sub 9pin x 1 (Male), RS-232C	Compatible
AUDIO IN	Stereo Mini Jack (Φ3.5 mm) x 1	0.5 V [rms]
AUDIO OUT	RCA Pin Jack x 2	Output: 0.5Vrms + 10%, with T.H.D. < 10%@1kHz.
LAN	RJ45 x 1 RJ45 10BASE-T/100BASE-TX	
USB	USB Type A Connector x 1, DC 5 V/2 A (USB 2.0 is supported)	

■ AUDIO

Built in Speaker	20W (10W+10W)
------------------	---------------

■ ELECTRICAL

Power Requirements	AC110-240 V 50 Hz/60 Hz 1.9-1.0 A
Power Consumption	142 W (Shipping Condition)
On Mode Average Power Consumption ¹	138 W (Picture Mode:)
Power Off Condition	Approx. 0.3 W
Stand-by Condition	Approx. 0.5 W
Apparent power	193 VA
Energy efficiency class for Europe	

1 Based on IEC 62087 Ed.2 measurement method

■ MECHANICAL

Dimension (W x H x D)	48.89" x 28.06" x 2.60" (1242 x 713 x 66 mm)
Weight	Approx. 15.6 kg (34.4 lbs)
Bezel Color	Black
Bezel Width	T/R/L/B 0.55" (13.9 mm)
Carton Dimensions (W x H x D)	53.15" x 33.86" x 6.30" (1350 x 860 x 160 mm)
Gross Weight	Approx. 23 kg (50.7 lbs)
Cabinet Material	Bezel: Metal, Back cover: Plastic
Pitch for Wall-Hanging	VESA Compliant 15.8" x 15.8" (400 x 400 mm) (Installed by: M6 screws / Screw hole depth: 0.71" (18 mm))

■ INSTALLATION

Orientation	Landscape / Portrait
Tilting Angle	Landscape / Portrait installation 0 - 20 degrees forward / backward

1 Please contact your sales representative with regard to the tilt angle before installation.

2 When you install the product upright, be sure to make the power lamp of the main body come to the upper side.

3 The on-screen menu does not rotate according to the installation orientation.

■ ENVIRONMENTAL

Operating Environment	Temperature : 32°F to 104°F (0°C to 40°C) ¹ ; 32°F to 95°F (0°C to 35°C) ² Humidity : 20% to 80% (No condensation)
-----------------------	---

1 : for up to 4593 ft (1400 m) altitude 2 : for between 4593 ft (1400 m) and 9186 ft (2800 m) altitude

· Depending on the temperature or humidity conditions, uneven brightness may be observed. This is not a malfunction.

· This unevenness will disappear while applying current continuously. If not, consult the distributor.

UPC Code	
----------	--

MAIN FEATURE

Auto Setup (PC)	Yes
Power Management (HDMI / PC)	Yes
Button lock	Yes
Remote Controller Lock	Yes
Dynamic contrast	Yes
Dynamic backlight control	Yes
Timer setting	Yes
SERIAL control (RS232C)	Yes
LAN control (PLink™)	Yes (Class2)
HDMI CEC Compatible	Yes
AMX D.D.	Yes
Multi Monitoring & Control Software	Yes
USB Media File Playback	Yes ¹
Memory Viewer	Yes
USB Auto-play*	Yes
Operating Time ²	24 h / day

* Photo and video cannot be played automatically at the same time.
 1 Still images and videos cannot be mixed.
 2 In case of running for a long time, the moving image is recommended to be displayed. If you display a still picture for an extended period, the image retention might remain on the screen. However, image retention can gradually disappear by displaying movie images.

STANDARD (CERTIFICATIONS)

SAFETY REGULATIONS	UL 62368-1 Ed. 3-2019 CSA C22.2 No. 62368-1:19 EN 62368-1:2014, (BS EN 62368-1:2014)
RADIATION REGULATIONS	Class A FCC 47 CFR Part 15 Subpart B ICES-003 Issue7 EN 55032:2015 EN 55032:2015/A11:2020 EN 55035:2017 EN 55035:2017/A11:2020 EN 61000-3-2:2014 EN 61000-3-3:2013

REMOTE CONTROL TRANSMITTER

Power Requirements	DC 3 V (AAA Size batteries x 2)
Operating distance	Approx. 23 ft (7 m)
Weight	Approx. 3.2 oz (91 g) including batteries
Dimensions (W x H x D)	1.9" x 7.5" x 1.1" (48 x 190 x 27 mm)

INCLUDED ACCESSORIES

- Remote Control - Batteries (AAA size) x 2
- AC cord (approx. 78.7" (approx. 2 m)) - Clamper x 2
- USB memory cover - Operating Instruction Book

OPTIONAL ACCESSORIES

Pedestal	TY-ST55PE9
----------	------------

DIMENSIONS

Cautions: This drawing is not a scale
Units : inches (mm)

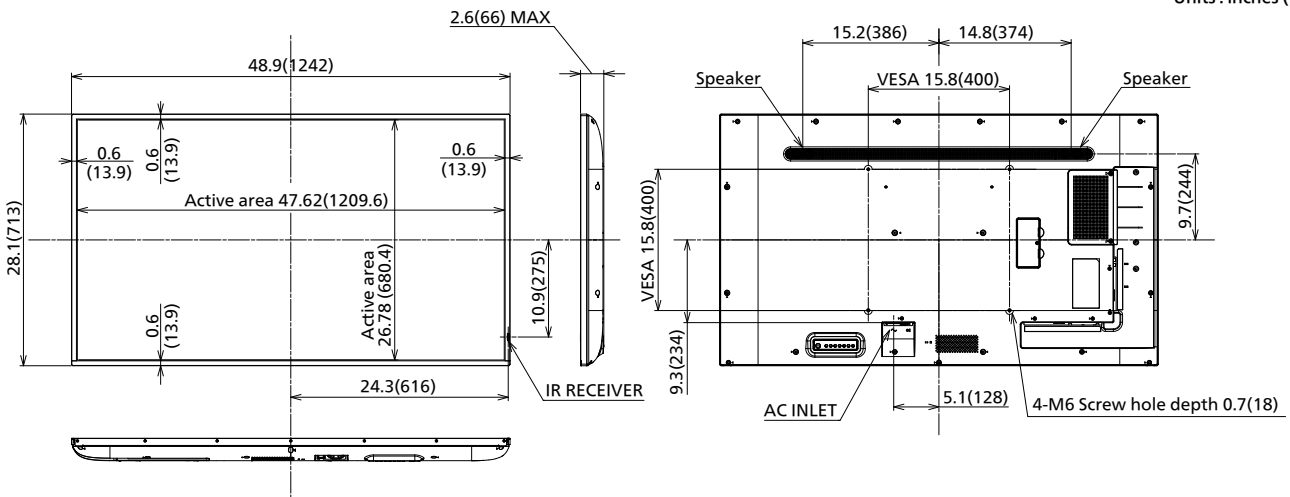

1 Some wall hanging brackets cannot be used due to the structures of the product. Check the product drawing before using.

CONNECTION TERMINAL

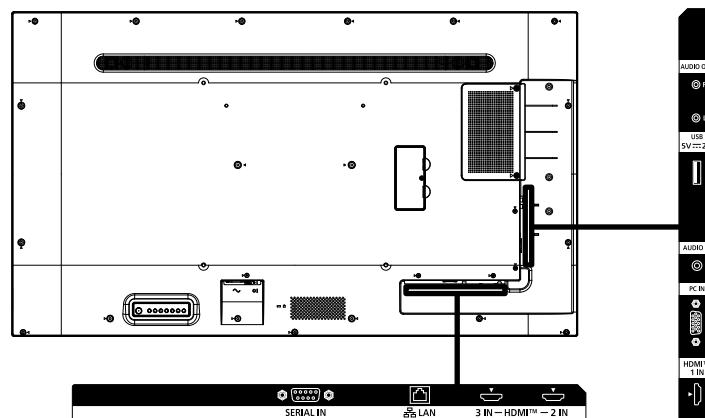

1 Specifications and appearance are subject to change without notice.

List of correspondence signals

The picture signal which can indicate this machine is as it is the following table.

Correspondence signal	Resolution (dot)	Scan rate		Dot clock rate (MHz)	Format ²	Plug and play compatible signal ⁴		
		Horizontal (kHz)	Vertical (Hz)			HDMI		PC
						EDID1	EDID2	
480/60i	720 (1440) x 480i ¹	15.73	59.94	27.00	H	○	○	-
576/50i	720 (1440) x 576i ¹	15.63	50.00	27.00	H	○	○	-
480/60p	720 x 480	31.47	59.94	27.00	H	○	○	-
576/50p	720 x 576	31.25	50.00	27.00	H	○	○	-
720/60p	1280 x 720	45.00	60.00	74.25	H	○	○	-
720/50p	1280 x 720	37.50	50.00	74.25	H	○	○	-
1080/60i	1920 x 1080i	33.75	60.00	74.25	H	○	○	-
1080/50i	1920 x 1080i	28.13	50.00	74.25	H	○	○	-
1080/24p	1920 x 1080	27.00	24.00	74.25	H	○	○	-
1080/25p	1920 x 1080	28.13	25.00	74.25	H	○	○	-
1080/30p	1920 x 1080	33.75	30.00	74.25	H	○	○	-
1080/60p	1920 x 1080	67.50	60.00	148.50	H	○	○	-
1080/50p	1920 x 1080	56.25	50.00	148.50	H	○	○	-
3840 x 2160/24p	3840 x 2160	54.00	24.00	297.00	H	○	○	-
3840 x 2160/25p	3840 x 2160	56.25	25.00	297.00	H	○	○	-
3840 x 2160/30p	3840 x 2160	67.50	30.00	297.00	H	○	○	-
3840 x 2160/60p	3840 x 2160	135.00	60.00	594.00	H	○	-	-
3840 x 2160/50p	3840 x 2160	112.50	50.00	594.00	H	○	-	-
4096 x 2160/24p	4096 x 2160	54.00	24.00	297.00	H	○	○	-
4096 x 2160/25p	4096 x 2160	56.25	25.00	297.00	H	○	○	-
4096 x 2160/30p	4096 x 2160	67.50	30.00	297.00	H	○	○	-
4096 x 2160/60p	4096 x 2160	135.00	60.00	594.00	H	○	-	-
4096 x 2160/50p	4096 x 2160	112.50	50.00	594.00	H	○	-	-
640 x 480/60	640 x 480	31.47	59.94	25.18	R/H	○	○	○
720 x 400/70	720 x 400	31.50	70.00	28.30	R/H	○	○	○
800 x 600/60	800 x 600	37.88	60.32	40.00	R/H	○	○	○
1024 x 768/60	1024 x 768	48.36	60.00	65.00	R/H	○	○	○
1280 x 720/60	1280 x 720	44.70	60.00	74.25	R/H	○	○	○
1280 x 800/60	1280 x 800	49.70	59.81	83.50	H	○	○	-
1280 x 960/60	1280 x 960	60.00	60.00	108.00	R/H	○	○	○
1280 x 1024/60	1280 x 1024	63.98	60.02	108.00	R/H	○	○	○
1280 x 1024/75	1280 x 1024	79.98	75.02	135.00	H	-	○	-
1360 x 768/60	1360 x 768	47.71	60.02	85.50	H	○	○	-
1400 x 1050/60	1400 x 1050	65.32	59.98	121.75	R/H	○	○	○
1440 x 900/60	1440 x 900	55.94	59.89	106.50	H	○	○	-
1600 x 900/60	1600 x 900 ³	60.00	60.00	108.00	R/H	○	○	○
1600 x 1200/60	1600 x 1200	75.00	60.00	162.00	H	○	○	-
1680 x 1050/60	1680 x 1050	65.29	59.95	146.25	R/H	○	○	○
1920 x 1080/60	1920 x 1080	67.50	60.00	148.50	R/H	○	○	○
1920 x 1200/60	1920 x 1200 ³	74.04	59.95	154.00	R/H	○	○	○

1 Pixel-Repetition signal (dot clock frequency 27.0 MHz) only

2 Alphabets inside the Format column represent as it follows.

R: D-sub RGB (PC IN)

H: HDMI (HDMI 1, HDMI 2, HDMI 3)

3 Based on VESA CVT-RB (Reduced Blanking) standard

4 Signals with ○ in the plug and play compatible signal column is the signal described in the EDID (extended display identification data) of the display. For the signals without ○ in the plug and play compatible signal column, the resolution may not be selected on the computer even if the display is supporting it.

Note

● The signal format distinguished automatically will be sometimes indication different from an actual input signal.

● [i] shown after the number of dots of resolution means the interlace signal.